

*HP LaserJet 8000, 8000 N,
8000 DN, and HP Mopier 240
Printers*



User Guide



© Copyright Hewlett-Packard Company
1998

All Rights Reserved. Reproduction,
adaptation, or translation without prior
written permission is prohibited, except as
allowed under the copyright laws.

Publication number
C4085-90997
Reorder part number
C4085-60101

First Edition, May 1998

Warranty

The information contained in this document
is subject to change without notice.

Hewlett-Packard makes no warranty of any
kind with respect to this information.
HEWLETT-PACKARD SPECIFICALLY
DISCLAIMS THE IMPLIED WARRANTY OF
MERCHANTABILITY AND FITNESS FOR A
PARTICULAR PURPOSE.

Hewlett-Packard shall not be liable for any
direct, indirect, incidental, consequential,
or other damage alleged in connection with
the furnishing or use of this information.

Trademark Credits

PostScript® is a trademark of Adobe
Systems Incorporated which may be
registered in certain jurisdictions.

Arial, Monotype, and Times New Roman
are U.S. registered trademarks of the
Monotype Corporation.

CompuServe is a U.S. trademark of
CompuServe, Inc.

Helvetica, Palatino, Times, and Times
Roman are trademarks of Linotype AG
and/or its subsidiaries in the U.S. and other
countries.

Microsoft, MS Windows, Windows, and
Windows NT are U.S. registered
trademarks of Microsoft Corporation.

TrueType is a U.S. trademark of Apple
Computer, Inc.

ENERGY STAR is a U.S. registered service
mark of the U.S. EPA.



HP Support

Thank you for your purchase. Along with your product, you receive a variety of support services from Hewlett-Packard and our support partners that are designed to give you the results you need, quickly and professionally.

Online Services: for 24-hour access to information over your modem, we suggest these services:

World Wide Web URL - Printer drivers, updated HP printer software, plus product and support information may be obtained from the following URLs:

in the U.S.	http://www.hp.com
in Europe	http://www2.hp.com

Printer drivers may be obtained from the following sites:

in Japan	ftp://www.jpn.hp.com/drivers
in Korea	http://www.hp.co.kr
in Taiwan	http://www.hp.com.tw
or the local driver website	http://www.dds.com.tw

HP Bulletin Board Service - Our electronic download service provides convenient access to HP printer drivers, updated HP printer software, product information, and troubleshooting hints. Set your communications software to N,8,1 and use the appropriate number below:

Australia	(61) (3) 9890-0276
Austria	43 (0)1 866 8920
Belgium	32 (0)2 778 38 19



China	(86) (10) 6261-4172
Denmark	45 (0) 45 991 905
Finland	358 (0)9 887 221 251
Korea	+82 2 01410 HITEL/GO HPK +82 2 01421 CHOLIAN/GO HPK
Netherlands	31 (0) 495 546909
New Zealand	(64) (9) 356-3660
Norway	47 22 735697
Portugal	351 (0)1 4417232
Switzerland	41 (0) 6 28897988
Taiwan	(886) (2) 923-3233
United Kingdom & Ireland	44 (0) 1344 360 880

America Online - America Online/Bertelsmann is available in the U.S., France, Germany, and U.K. - Printer drivers, updated HP printer software, and support documentation to help answer your questions about HP products are available. Use Keyword HP to start your tour or call 1-800-827-6364 preferred customer # 1118 to subscribe. In Europe, call the appropriate number below:

Austria	0222 58 58 485
France	++353 1 704 90 00
Germany	0180 531 31 64
Switzerland	0848 80 10 11
United Kingdom	0800 279 1234

CompuServe - Printer drivers, updated HP printer software, and interactive sharing of technical information with other members is available on CompuServe's "HP User's forums" (GO HP), or call 1-800-524-3388 and ask for representative #51 to subscribe. (CompuServe is also available in the U.K., France, Belgium, Switzerland, Germany, and Austria.)



Obtaining software utilities and electronic Information for U.S. and Canada:**Phone:** (1) (970) 339-7009**Mail:**Hewlett-Packard Co.
P.O. Box 1754
Greeley, CO 80632
U.S.A.**Fax:** (1) (970) 330-7655**For Asia-Pacific countries:**

Contact Fulfill Plus at (65) 740-4477 (Hong Kong, Indonesia, Philippines, Malaysia, or Singapore). For Korea, call (82) (2) 3270-0805 or (82) (2) 3270-0893.

For Australia, New Zealand, and India:

For Australia and New Zealand, call (61) (2) 565-6099.
For India, call (91) (11) 682-6035.



For European English:

For U.K., call (44) (142) 986-5511. For Ireland and outside U.K., call (44) (142) 986-5511.

HP direct ordering for accessories or supplies:

Call 1-800-538-8787 (U.S.) or 1-800-387-3154 (Canada).

HP Support Assistant compact disc:

This support tool offers a comprehensive online information system designed to provide technical and product information on HP products. To subscribe to this quarterly service in the U.S. or Canada, call 1-800-457-1762. In Hong Kong, Indonesia, Malaysia, or Singapore, call Fulfill Plus at (65) 740-4477.

HP Service Information:

To locate HP-Authorized Dealers, call 1-800-243-9816 (U.S.) or 1-800-387-3867 (Canada).

HP Service Agreements:

Call 1-800-835-4747 (U.S.) or 1-800-268-1221 (Canada).

Extended Service 1-800-446-0522



HP FIRST: HP FIRST Fax will deliver detailed troubleshooting information on common software and troubleshooting tips for your HP product. Call from any touch tone phone and request up to three documents per call. These documents will be sent to the fax of your choice.

Australia	(61) (3) 9272-2627
Austria	(43) (1) 0660-8128
Belgium (Dutch)	(32) (2) 0800-11906
Belgium (French)	(32) (2) 0800-17043
Canada	1-800-333-1917
China	(86) (10) 6505-5280
Denmark	(45) 8001-0453
English (outside of U.K.)	(31) (20) 681-5792
Finland	(358) (9) 0800-13134
France	(33) (01) 43-62-3444
Germany	(49) (13) 081-0061
Hong Kong	(852) 2506-2422
Hungary	(36) (1) 252-4647
India	(91) (11) 682-6035
Indonesia	(62) (21) 352-2044
Italy	(39) (2) 1678-59020
Japan	(81) (3) 3335-8622
Korea	(82) (2) 769-0543
Malaysia	(60) (3) 298-2478
Netherlands	(31) (20) 0800-222420
New Zealand	(64) (9) 356-6642
Norway	(47) 800-11319
Portugal	(351) (1) 0505-313342
Philippines	(65) 291-7951



Singapore	(65) 275-7251
Spain	(34) (90) 099-3123
Sweden	(46) (2) 079-5743
Switzerland (German)	(41) (1) 0800-551527
Switzerland (French)	(41) (1) 0800-551526
Taiwan	(886) (2) 719-5589
Thailand	(66) (2) 661-3511
United Kingdom	(44) (134) 0800-960271
United States	1-800-333-1917



Customer support options worldwide

The service and support chapter of this user guide contains worldwide sales and service addresses and phone numbers for countries not listed here.

Customer Support and Product Repair Assistance for the U.S. and Canada:

(Refer to the service and support chapter of this user guide for additional product repair information.)

Call (1) (208) 323-2551 Monday through Friday from 6 am to 6 pm, (Mountain Time) free of charge during the warranty period. However, your standard long-distance phone charges still apply. Have your system nearby and your serial number ready when calling.

If you know your printer needs repair, call 1-800-243-9816 to locate your nearest HP-Authorized service provider, or call 800-633-3600 for HP centralized service dispatch.

Post-warranty telephone assistance is available to answer your product questions. Call (1) (900) 555-1500 (\$2.50* per minute, U.S. only) or call 1-800-999-1148 (\$25* per call, Visa or MasterCard, U.S. and Canada) Monday through Friday from 7 am to 6 pm and Saturday from 9 am to 3 pm (Mountain Time). *Charges begin only when you connect with a support technician.*

**Prices subject to change.*



European Customer Support Center Language and In-Country Options Available
Open Monday through Friday 8:30–18:00 CET

HP provides a free telephone support service during the warranty period. By calling a telephone number listed below, you will be connected to a responsive team waiting to help you. If you require support after your warranty has expired, you can receive support for a fee through the same telephone number. The fee is charged on a per-incident basis. When calling HP, have the following information ready: product name and serial number, date of purchase, and description of the problem.

English

Ireland: (353) (1) 662-5525
U.K.: (44) (171) 512-5202

Dutch

International: (44) (171) 512-5202
Belgium: (32) (2) 626-8806
Netherlands: (31) (20) 606-8751

French

France: (33) (01) 43-62-3434
Belgium: (32) (2) 626-8807
Switzerland: (41) (84) 880-1111

German

Germany: (49) (180) 525-8143



Austria: (43) (1) 0660-6386

Norwegian

Norway: (47) 2211-6299

Danish

Denmark: (45) 3929-4099

Finnish

Finland: (358) (9) 0203-47288

Swedish

Sweden: (46) (8) 619-2170

Italian

Italy: (39) (2) 264-10350

Spanish

Spain: (34) (90) 232-1123

Portuguese

Portugal: (351) (1) 441-7199

In-country support numbers: If you require support after your warranty has expired, additional product repair services, or if your country is not listed below, see [“Worldwide Sales and Service Offices.”](#)

Argentina 787-8080

Australia (61) (3) 272-8000



Brazil	022-829-6612
Canada	(1) (208) 323-2551
China	(86) (10) 65053888-5959
Chile	800-360999
Czech Republic	(42) (2) 471-7321
Greece	(30) (1) 689-6411
Hong Kong	(852) 800-96-7729
Hungary	(36) (1) 343-0310
India	(91) (11) 682-6035
	(91) (11) 682-6069
Indonesia	(62) (21) 350-3408
Korea	(82) (2) 3270-0700
Korea outside Seoul, call	(82) (080) 999-0700
Japan	(81) (3) 3335-8333
Malaysia	(60) (3) 295-2566
Mexico (Mexico City)	01 800-22147
Mexico (outside Mexico City)	01 800-90529
New Zealand	(64) (9) 356-6640
Philippines	(63) (2) 894-1451
Poland	(48) (22) 37-5065
Portugal	(351) (1) 301-7330
Russia	(7) (95) 923-5001
Singapore	(65) 272-5300
Taiwan	(886) (02) 717-0055
Thailand	+66 (0) 2 661-4011
Turkey	(90) (1) 224-5925



Contents

Introduction

<u>Navigation Features</u>	<u>18</u>
<u>Text Conventions</u>	<u>20</u>
<u>Additional Features of</u>	
<u>Acrobat Reader</u>	<u>21</u>
<u>Tips for Use</u>	<u>23</u>

1 Printer Basics

<u>Overview</u>	<u>24</u>
<u>Printer Features and Benefits</u>	<u>25</u>
<u>Printer Information</u>	<u>29</u>
<u>Configurations</u>	<u>29</u>
<u>Printer Parts and Locations</u>	<u>31</u>
<u>Accessories and Supplies</u>	<u>33</u>
<u>Suggested Accessories</u>	<u>34</u>
<u>Ordering Information</u>	<u>36</u>
<u>Control Panel Layout</u>	<u>44</u>
<u>Control Panel Lights</u>	<u>45</u>
<u>Configuration Page</u>	<u>45</u>
<u>Control Panel Keys</u>	<u>46</u>
<u>Control Panel Menus</u>	<u>48</u>
<u>LEDs Status Interpretation</u>	<u>50</u>

<u>Printer Software</u>	<u>52</u>
<u>Printer Drivers</u>	<u>55</u>
<u>Software for Windows</u>	<u>58</u>
<u>Installing Windows Printing</u>	
<u>Software (CD)</u>	<u>59</u>
<u>Installing Network Software</u>	<u>61</u>
<u>Installing Macintosh Printing Software</u>	<u>62</u>
<u>Software for Macintosh Computers</u>	<u>69</u>
<u>Software for Networks</u>	<u>71</u>

2 Printing Tasks

<u>Overview</u>	<u>75</u>
<u>Selecting the Input Tray</u>	<u>76</u>
<u>Loading Tray 1</u>	<u>76</u>
<u>Loading Trays 2, 3, and the</u>	
<u>Optional 2 x 500-sheet Input Tray</u>	
<u>(Trays 4 and 5)</u>	<u>80</u>
<u>Loading the Optional 2000-sheet</u>	
<u>Input Tray (Tray 4)</u>	<u>84</u>
<u>Selecting the Output Bin</u>	<u>88</u>
<u>Printing to the Standard Output Bin</u>	<u>90</u>
<u>Printing to the Left Output Bin</u>	<u>92</u>
<u>Printing to a Mailbox</u>	<u>93</u>



[Using the Stapler](#) 98

[Loading Staple Cartridges](#) 98

[Stapling Documents](#) 100

[Printing Both Sides of Paper](#)
(Optional Duplex Printing Accessory) . . . 102

[Printing Envelopes](#) 107

[Feeding Envelopes Automatically](#)
(Optional Envelope Feeder) 107

[Inserting the Envelope Feeder](#) 109

[Loading Envelopes into the Envelope Feeder](#) 110

[Printing Envelopes from Tray 1](#) 111

[Printing Special Paper](#) 114

[Printing Letterhead or Preprinted Paper](#) 114

[Printing Labels](#) 115

[Printing Transparencies](#) 117

[Custom-size Paper in Tray 1](#) 118

[Printing Cards, Custom-size and Heavy Paper](#) 121

3 Advanced Printing Tasks

[Overview](#) 124

[Using Features in the Printer Driver](#) 125

[Different First Page](#) 128

[Printing Multiple Pages on One Sheet of Paper](#) 130

[Customizing Tray 1 Operation](#) 131

[Tray 1 Mode=First](#) 131

[Tray 1 Mode=Cassette](#) 132

[Manually Feeding Paper from Tray 1](#) . 133

[Printing by Type and Size of Paper](#) 134

[Benefits of Printing by Type and Size of Paper](#) 134

4 Printer Maintenance

[Overview](#) 136

[Managing the Toner Cartridge](#) 137

[HP Policy on Non-HP Toner Cartridges](#) 137

[Toner Cartridge Storage](#) 137

[Toner Cartridge Life Expectancy](#) 138

[Continue Printing When Toner is Low](#) . 139

[Cleaning the Printer](#) 141

5 Problem Solving

[Overview](#) 144

[Clearing Paper Jams](#) 146

[Clearing Jams from the Input Tray Areas](#) 148

[Clearing Jams from the Optional Duplex Printing Accessory](#) 157

[Clearing Jams from the Top Cover Area](#) 159



Clearing Jams from the Output Areas	160
Clearing Jams from the Stapler	164
Solving Repeated Paper Jams	166
Understanding Printer Messages	168
Correcting Output Quality Problems	186
Troubleshooting Checklist	188
Determining Printer Problems	189
Software, Computer, and Printer Interface Problems	191
Cabling Configurations	210
Selecting an alternate PPD	219
Communicating with an Optional HP JetDirect 600N Print Server	221
Checking the Printer's Configuration	227
Configuration Page	228
Configuration Page	229
Menu Map	231
PCL or PS Font List	232
File Directory Page	234
Event Log Page	235

[6 Service and Support](#)

Overview	236
Hewlett-Packard limited warranty statement	237
Service During and After the Warranty Period	239

Limited Warranty for Toner Cartridge Life	240
HP Software License Terms	242
Worldwide Sales and Service Offices	245

[Appendix A Specifications](#)

Overview	253
Paper Specifications	254
Supported Sizes of Paper for Input and Output	256
Supported Types of Paper	259
Labels	265
Transparencies	266
Envelopes	267
Card Stock and Heavy Paper	271
Printer Specifications	273
Physical Dimensions	273
Environmental Specifications	276

[B Control Panel Menus](#)

Overview	279
Information Menu	281
Paper Handling Menu	283
Print Quality Menu	287
Printing Menu	290
Configuration Menu	295
I/O Menu	302



[EIO Menu \(8000 N/8000 DN\)](#) 305
[Resets Menu](#) 308

[Appendix C Printer Memory and Expansion](#)

[Overview](#) 310
[Installing Memory](#) 312
[Checking Memory Installation](#) 315
[Adjusting Memory Settings](#) 316
[Installing EIO Cards/Mass Storage](#) 320

[Appendix D Printer Commands](#)

[Overview](#) 321
[Understanding PCL Printer
 Command Syntax](#) 323
 [Combining Escape Sequences](#) 324
 [Entering Escape Characters](#) 325
[Selecting PCL Fonts](#) 326
[Common PCL Printer Commands](#) 327

[Multibin Mailbox Commands](#) 335

[Appendix E Regulatory Information](#)

[Overview](#) 340
[FCC Regulations](#) 341
[Environmental Product Stewardship](#) 342
 [Protecting the Environment](#) 342
[Material Safety Data Sheet](#) 346
[Environmental Conformity](#) 347
[Declaration of Conformity](#) 349
[Safety Statements](#) 353
 [Laser Safety Statement](#) 353
 [Canadian DOC Regulations](#) 353
 [VCCI Statement \(Japan\)](#) 354
 [Korean EMI statement](#) 354
 [Laser Statement for Finland](#) 355

[Index](#)



Introduction



This section explains some of the features of this online user guide as well as tips and tricks to help you use it to its greatest potential. It provides an overview of the following information:

- [Navigation Features](#)
- [Text Conventions](#)
- [Additional Features of Acrobat Reader](#)
- [Tips for Use](#)









Additional features can be accessed through your Acrobat Reader menus and toolbars.



Navigation Features



Button	Button Name	Function
 	Chapter Beginning and End Arrows	The Chapter Beginning and End buttons allow you to go to the beginning or end of a chapter. The Up arrow takes you to the beginning of the chapter, while the Down arrow takes you to the end.
 	Page Up and Down Arrows	The Page Up and Down arrows allow you to scroll page-by-page through a chapter. The Page Up arrow allows you to go back one page, while the Page Down arrow allows you to move forward one page.
	Table of Contents Icon	This Table of Contents Icon calls up the table of contents for the online user guide. It appears on all pages except those that are part of the table of contents.
	Introduction Icon	The Introduction Icon calls up this introduction to the guide.



Button	Button Name	Function
	Index Icon	The Index Icon calls up the online user guide text index. The index entries are linked to their related topics.



Text Conventions

Some text is formatted differently to indicate specific meanings or functions. Below is a table that defines the different text formats and what they indicate.







Text Format Style	Meaning or Function
KEY CAP	This format is used to represent buttons on the printer, as well as keys on the computer keyboard.
<u>Hypertext</u>	This format is used to indicate that the text is linked to another page of the document. Clicking on the underlined text takes you to that page. Sometimes, a page number and section heading are included in the blue underlined text, but any text formatted this way indicates the presence of a link.
Input	This format indicates that the text is typed by the user at a command prompt or into a dialog box.



Additional Features of Acrobat Reader





In addition to the navigation buttons provided on the right side of the page, Adobe Acrobat Reader has a number of other features that you may find useful.



Button	Button Name	Function
	Actual Size	This button sets the document view to the page's actual size.
	Fit Page	This button changes the document view so the page fits in the window.
	Fit Visible Width	This button changes the document view so the visible content and page width fit in the window.
	Page Only	This button displays the page only with no bookmarks or thumbnails.





Button	Button Name	Function
	Page With Bookmarks	This button displays the page and bookmarks to the different sections of the document in a window to the left of the screen.
	Page With Thumbnails	This button displays the page and small images of each page in a window to the left of the screen.
	Back	This button allows you to go to the previous link or to undo your last change.
	Find	This button calls up the Find dialog.
	Zoom	This button allows you to change the page size.



Tips for Use

Use bookmarks to navigate between chapters.

When reading large amounts of text, turn off bookmarks and change the page view to full screen.

Use the find function under the Tools menu to find specific terms.

To print this document- For best quality and quickest printing, always print using a compatible PostScript Level 2 emulation printer driver.



1 *Printer Basics*

Overview

Congratulations on your purchase of an HP LaserJet 8000 series or an HP Mopier 240 printer. If you have not done so, see the getting started guide provided with the printer for setup instructions.

Now that the printer is set up and ready to use, take a few moments to get to know the printer. This chapter introduces the following:

- [Printer Features and Benefits](#)
- [Printer Information](#)
- [Accessories and Supplies](#)
- [Control Panel Layout](#)
- [LEDs Status Interpretation](#)
- [Printer Software](#)



Printer Features and Benefits

Speed and Throughput

- RIP ONCE technology
- 24 pages per minute (ppm)
- 133 MHz MIPS microprocessor

Resolution

- 600 dots per inch (dpi) with Resolution Enhancement technology (REt)
- FastRes 1200 provides 1200 dpi quality at full speed
- More than 220 levels of gray

Memory

- 16 MB (8000/8000 N) or 24 MB (8000 DN) of RAM, expandable using industry standard 100-pin DIMMs (Dual In-Line Memory Modules)
- Memory Enhancement technology (MEt) automatically compresses data to use RAM more efficiently



Language and Fonts

- HP PCL 6
- HP PCL 5e for compatibility
- Printer Job Language (PJL)
- Printer Management Language (PML)
- 45 scalable TrueType typefaces
- 65 fonts with HP FontSmart (not available for Macintosh)
- PostScript Level 2 Emulation standard



Paper Handling Options

- **Input**

- ◆ **Tray 1:** A multipurpose tray for paper, transparencies, labels, and envelopes. Holds up to 100 sheets of paper.
- ◆ **Trays 2 and 3:** Two 500-sheet trays. These trays automatically sense paper size.
- ◆ **Optional 2 x 500-sheet Input Tray (Trays 4 and 5):** Two 500-sheet trays. These trays automatically sense paper size.
- ◆ **Optional 2000-sheet Input Tray (Tray 4):** One 2000-sheet tray. This tray automatically senses paper size.
- ◆ **Optional Duplex Printing Accessory:** Provides two-sided printing (both sides of paper).
- ◆ **Optional Envelope Feeder:** Automatically feeds up to 100 envelopes.

- **Output**

- ◆ **Standard Output Bin:** Holds up to 500 sheets of paper. Automatically senses when full.
- ◆ **Left Output Bin:** Holds up to 125 sheets of paper. Provides the best results when printing transparencies, labels, and envelopes.
- ◆ **Optional 5-bin Mailbox with Stapler:** Each of the 5 bins holds up to 250 sheets of paper. Provides job separation by stapling jobs.

Continued on next page.



- ◆ **Optional Multibin Mailbox:** Each of the 8 bins holds up to 250 sheets of paper.
- ◆ **Optional 7-bin Tabletop Mailbox:** Each of the 7 bins holds up to 120 sheets of paper. Designed for tabletop printing.



Connectivity

- 3 EIO (enhanced input/output) slots
- HP JetDirect EIO cards, Ethernet (10Base-T, 10Base2), Local Talk, Token Ring, Fast Ethernet 10/100Base-TX
- Parallel



Environmental Features

- EconoMode reduces toner consumption
- Power Save setting saves energy (meets Energy Star guidelines)
- High content of recyclable components and materials in the printer



Printer Information

Configurations

HP LaserJet 8000 printer

The HP LaserJet 8000 printer (part number C4085A) comes standard with 16 MB RAM, wide format printing, two 500-sheet trays, and a 100-sheet multipurpose tray.

HP LaserJet 8000 N printer

The HP LaserJet 8000 N printer (part number C4086A) comes standard with 16 MB RAM, wide format printing, two 500-sheet trays, a 100-sheet multipurpose tray, and an HP JetDirect 600N for 10/100Base-TX, internal print server.

Continued on next page.

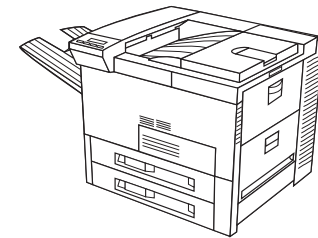
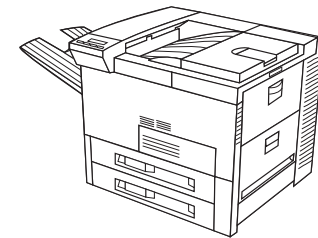

HP LaserJet 8000 DN printer

The HP LaserJet 8000 DN printer (part number C4087A) comes standard with 24 MB RAM, wide format printing, two 500-sheet trays, a 100-sheet multipurpose tray, an HP JetDirect 600N for 10/100Base-TX, internal print server, and a duplexer (for printing on both sides of paper).

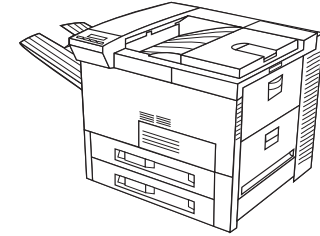

HP Mopier* 240

The HP Mopier 240 printer with advanced paper handling devices, such as the 2000-sheet Input Tray and 5-bin Mailbox with Stapler, enables you to easily produce multiple sets of multipage documents—collated, duplexed, and stapled—directly from your desktop and without having to walk to the photocopier.

*Available through HP-qualified distribution.



Printer Parts and Locations

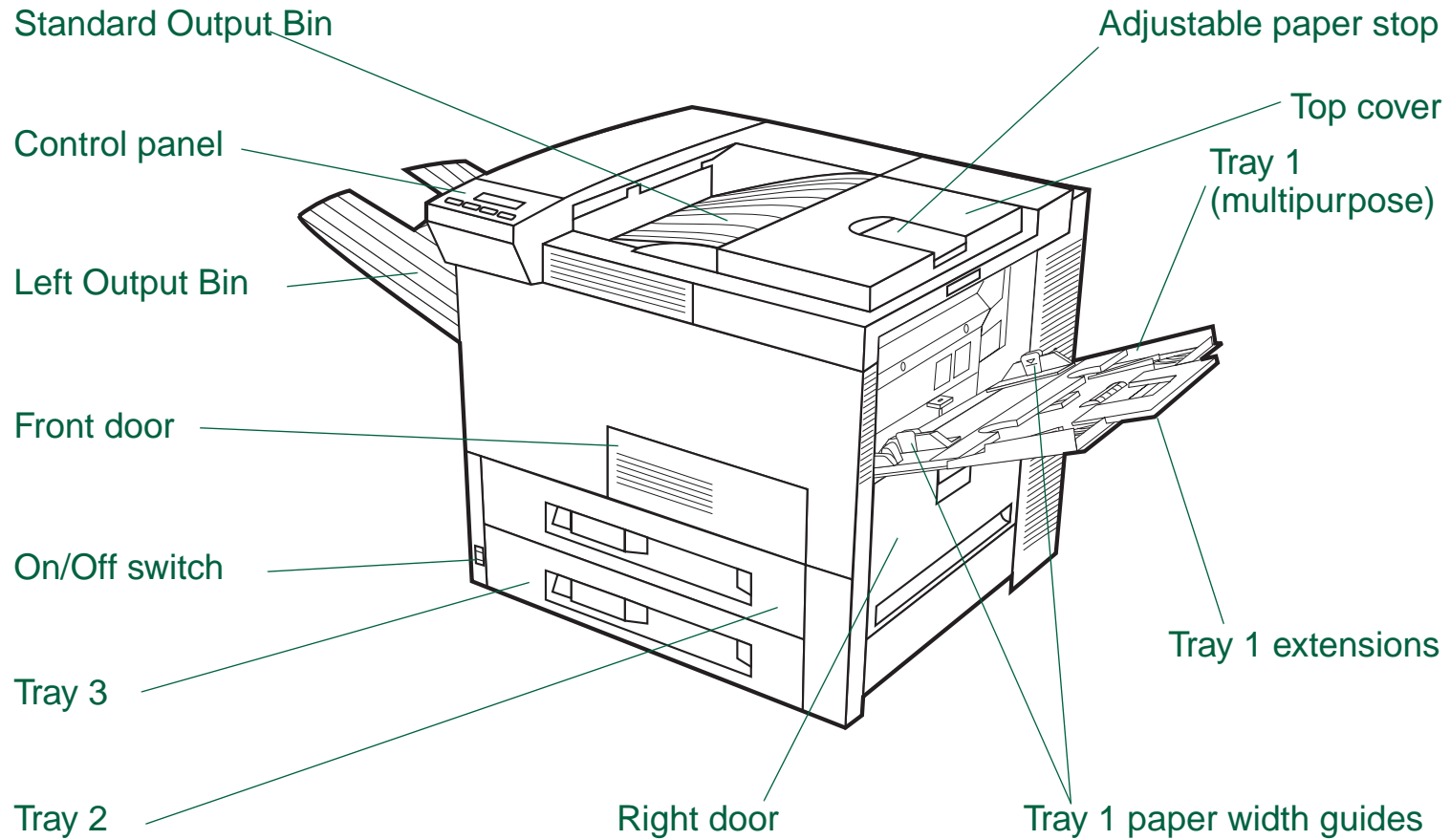

Continued on next page.



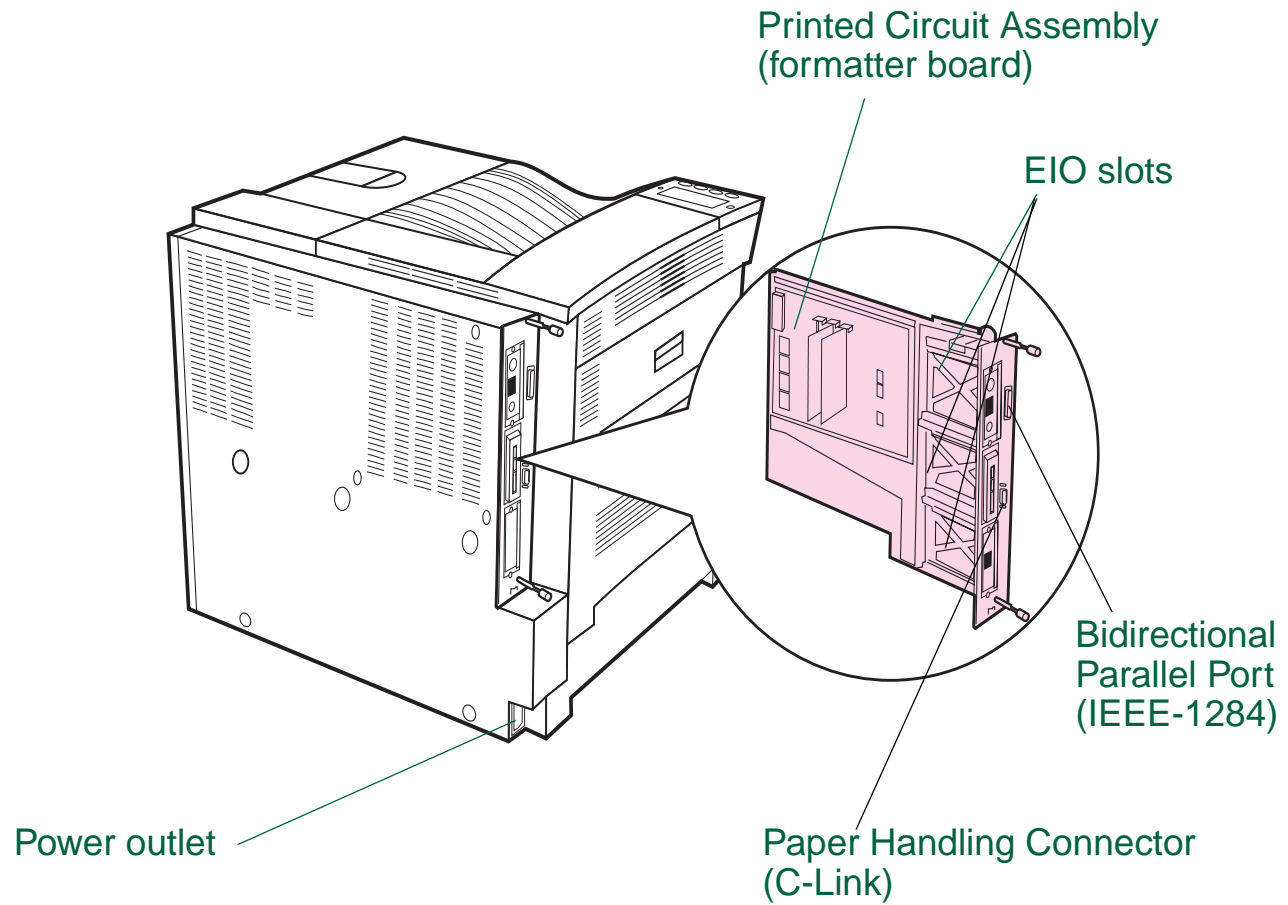

Accessories and Supplies

You can increase the capabilities of the printer with optional accessories and supplies.

Use accessories and supplies specifically designed for the printer to ensure optimum performance.

The printer supports three enhanced input/output (EIO) cards. Other accessories and options are available. For ordering information, see page [36](#).



Suggested Accessories

5-bin Mailbox with Stapler

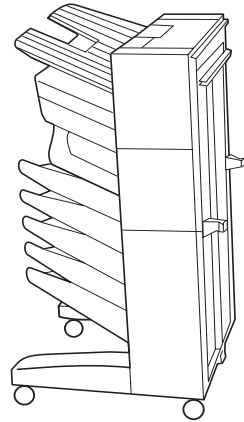

Multibin Mailbox (8 bins)

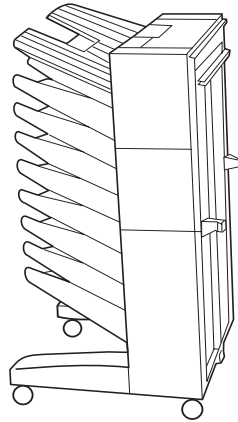

Duplexer

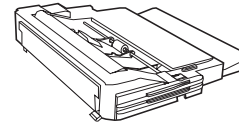

Envelope Feeder

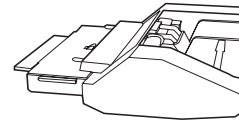

7-bin Tabletop Mailbox

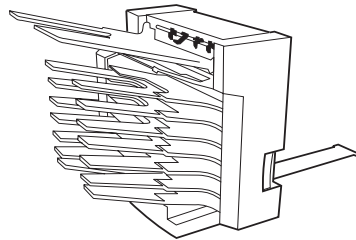

Stand for 7-bin Tabletop Mailbox

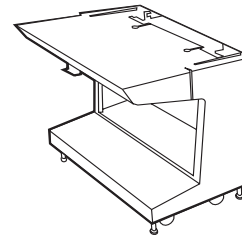

2000-sheet Input Tray (Tray 4)

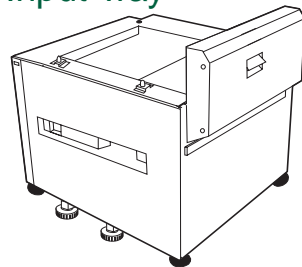

2 x 500-sheet Input Tray (Trays 4 and 5)

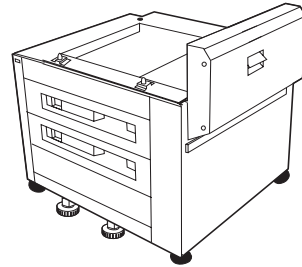

Printer Stand

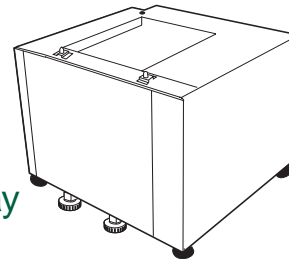

Optional Hard Disk

The Hard Disk accessory can be used to permanently store downloaded fonts and forms in the printer. Unlike standard printer memory, items on the Hard Disk remain in the printer even when the printer is turned off. Fonts downloaded to the Hard Disk are available to all users of the printer.

The Hard Disk can be write-protected through software for additional security.

Windows Users

Use HP JetAdmin to delete files from a mass storage device. Use HP FontSmart to manage fonts on a mass storage device (page [67](#)). For more information, see the printer software help.

HP is constantly introducing new software tools for use with your printer and accessories. These tools are available from the Internet free of charge. See page [3](#) for how to visit the HP website for more information.

Macintosh Users

Use the HP LaserJet Utility to download fonts. Refer to the HP LaserJet Utility Guide online help included with your HP LaserJet Utility software for more information.



Ordering Information

Use only accessories specifically designed for this printer. To order an accessory, contact an HP-authorized service or support provider. (See the [HP Support](#) pages at the front of this user guide.)



Ordering Information

	Item	Description or Use	Order Number
Paper Handling	2 x 500-sheet Input Tray	Two 500-sheet trays and feeder.	C4780A
	2000-sheet Input Tray	One 2000-sheet tray and feeder.	C4781A
	Envelope Feeder	Automatically feeds up to 100 envelopes.	C3765B
	Duplex Printing Accessory (duplexer)	Allows automatic printing on both sides of paper.	C4782A
	7-bin Tabletop Mailbox	Each of the 7 output bins holds 120 sheets of paper. Designed for tabletop use.	C4783A



Ordering Information (continued)

	Item	Description or Use	Order Number
Paper Handling	Multibin Mailbox	Each of the 8 output bins holds 250 sheets of paper.	C4785A
	5-bin Mailbox with Stapler	Each of the 5 output bins holds 250 sheets of paper. Provides job separation by stapling jobs.	C4787A
Printer Stands	Printer Stand	Used in place of the 2000-sheet Input Tray (Tray 4) or the 2 x 500-sheet Tray (Trays 4 and 5) when a mailbox accessory is attached.	C2975A
	Stand for 7-bin Tabletop Mailbox	Allows 7-bin Tabletop Mailbox to be used when printer is mounted on 2 x 500-sheet Input Tray, 2000-sheet Input Tray, or printer stand.	C4784A



Ordering Information (continued)

	Item	Description or Use	Order Number
Printing Supplies	HP Multipurpose Paper (Other HP media is available where office products are sold.)	HP brand paper for a variety of uses (1 box of 10 reams, 500 sheets each). To order a sample, in the U.S. call 1-800-471-4701.	HPM1120
	HP LaserJet Paper (Other HP media is available where office products are sold.)	Premium HP brand paper for use with HP LaserJet printers (1 box of 10 reams, 500 sheets each). To order a sample, in the U.S. call 1-800-471-4701.	HPJ1124
	Toner Cartridge (15,000 pages)	Replacement HP Microfine toner cartridge.	C3909A



Ordering Information (continued)

Item	Description or Use	Order Number
Memory, Fonts, and Mass Storage	Dual In-line Memory Module (DIMM) (100-pin)	Boosts the ability of the printer to handle large print jobs (maximum 192 MB with HP brand DIMMs):
	EDO DIMMs (100-pin)	4 MB C4135A 8 MB C4136A 16 MB C4137A
	SDRAM DIMMs (100-pin)	4 MB C4140A 8 MB C4141A 16 MB C4142A 32 MB C4143A 64 MB C3913A
	Flash DIMM (100-pin)	Permanent storage for fonts and forms: 2 MB C4286A 4 MB C4287A



Ordering Information (continued)

Item	Description or Use	Order Number
Memory, Fonts, and Mass Storage	Font DIMM (100-pin)	8 MB Asian ROM: traditional Chinese simplified Chinese Korean
	C4292A C4293A D4838A	
	Hard Disk	Permanent storage for fonts and forms. Enables RIP ONCE mopying of print jobs that are too large to RIP ONCE mopy in RAM.
Cable and Interface Accessories	Parallel Cables	3 Meter IEEE-1284 cable 10 Meter IEEE-1284 cable
	C2946A C2947A	
	Macintosh Network Cable Kit	For PhoneNET or LocalTalk connection.



Ordering Information (continued)

Item	Description or Use	Order Number
Cable and Interface Accessories	Enhanced I/O Cards	HP JetDirect print server multi-protocol EIO network cards:
	Ethernet RJ-45 only	J3110A
	Ethernet RJ-45 and BNC, LocalTalk	J3111A
	Token Ring RJ-45 and DB-9	J3112A
	Fast Ethernet 10/100Base-TX RJ-45 only	J3113A
	Power Box	For connecting a multibin mailbox to the printer when the printer is on a printer stand. This item is included with the 2000-sheet Input Tray and the 2 x 500-sheet Input Tray.
Maintenance Accessory	Preventive Maintenance Kit	For 110V units For 220V units
		C3971B
		C3972B



Ordering Information (continued)

Item	Description or Use	Order Number
Documentation <i>HP LaserJet Printer Family Paper Specification Guide</i>	A guide to using paper and other print media with HP LaserJet printers.	5010-6394
<i>PCL 5/PJL Technical Reference Documentation Package</i>	A guide to using printer commands with HP LaserJet printers.	5021-0330
<i>HP LaserJet 8000, 8000 N, 8000 DN, and HP Mopier 240 Printers User Guide</i>	This is an online user guide provided on compact disc.	C4085-60101
<i>HP LaserJet 8000, 8000 N, 8000 DN, and HP Mopier 240 Printers Getting Started Guide</i>	An additional copy of the getting started guide.	C4085-90901



Ordering Information (continued)

Item	Description or Use	Order Number
<i>HP LaserJet 8000, 8000 N, 8000 DN, and HP Mopier 240 Printers Ready Reference Guide</i>	An additional copy of the ready reference guide.	C4085-90921
User Documentation Bundle	An additional copy of the getting started guide, and the ready reference guide.	C4085-90901



Control Panel Layout

The control panel includes three indicator lights, six keys, and a 2-line display (16 characters per line).

2-line display

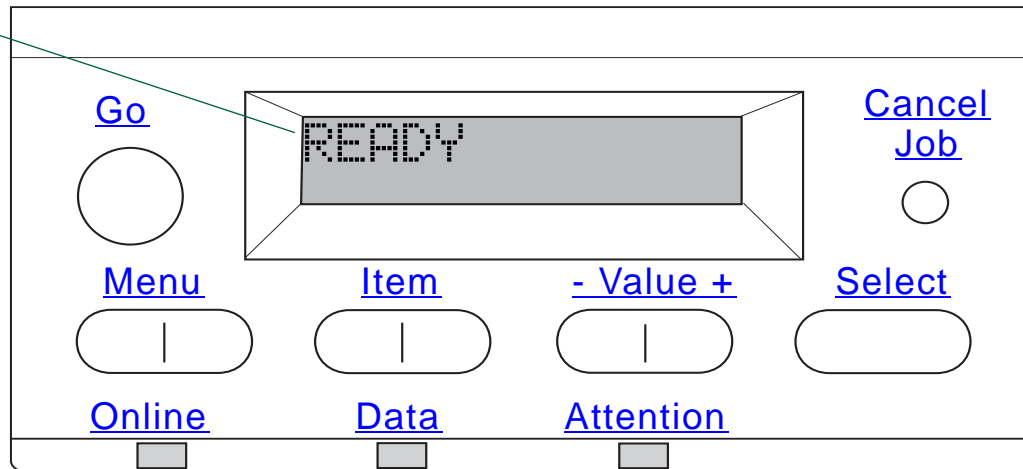

Control Panel Lights



Light	Indication
Online	The printer is ready to print.
Data	The printer is processing information.
Attention	Action is required. See the control panel display.



Configuration Page

To print a configuration page, see page [228](#).



Control Panel Keys

Control Panel Keys

Key	Function
Go	<ul style="list-style-type: none"> ● Places the printer either online or offline. ● Prints any data residing in the printer's buffer. ● Allows the printer to resume printing after being offline. Clears most printer messages and places the printer online. ● Allows the printer to continue printing with an error message such as TRAY x LOAD [TYPE] [SIZE] or UNEXPECTED PAPER SIZE. ● Confirms a manual feed request if Tray 1 is loaded and TRAY 1 MODE=CASSETTE has been set from the Paper Handling Menu in the printer's control panel. ● Overrides a manual feed request from Tray 1 by selecting paper from the next available tray. ● Exits the control panel menus. (To save a selected control panel setting, first press SELECT.)
CANCEL JOB	<p>Cancels the print job that the printer is processing. The time it takes to cancel depends on the size of the print job. (Press it only once.)</p>
MENU	<p>Cycles through the control panel menus. Press the right end of the button to move forward or the left end of the button to move backward.</p>
ITEM	<p>Cycles through the selected menu's items. Press the right end of the button to move forward or the left end of the button to move backward.</p>



Control Panel Layout

Control Panel Keys

Key	Function
- VALUE +	Cycles through the selected menu item's values. Press + to move forward or - to move backward.
SELECT	<ul style="list-style-type: none">● Saves the selected value for that item. An asterisk (*) appears next to the selection, indicating that it is the new default. Default settings remain when the printer is switched off or reset (unless you reset all factory defaults from the Resets Menu).● Prints one of the printer information pages from the control panel.

**Control Panel Layout**

Control Panel Menus

For a complete list of control panel items and possible values, see page [279](#).

Press **MENU** for access to all control panel menus. When additional trays or other accessories are installed in the printer, new menu items automatically appear.

Continued on next page.



To change a control panel setting:

1. Press **MENU** until the desired menu appears.
2. Press **ITEM** until the desired item appears.
3. Press - **VALUE** + until the desired setting appears.
4. Press **SELECT** to save the selection. An asterisk (*) appears next to the selection in the display, indicating that it is now the default.
5. Press **GO** to exit the menu.



Note

Settings in the printer driver and software application override control panel settings. (Software application settings override printer driver settings.)

If you cannot access a menu or item, it is either not an option for the printer, or your network administrator has locked the function. (The control panel reads ACCESS DENIED MENUS LOCKED.) See your network administrator.



To print a control panel menu map:

See page [231](#) for information on how to print a control panel menu map.



LEDs Status Interpretation

Use the following table to interpret the status lights on the Optional 2000-sheet Input Tray, the Optional 2 x 500-sheet Input Tray (Trays 4 and 5), and the Multibin Mailbox.



LED Status Interpretation

Light	Optional 2000-sheet Input Tray and the Optional 2 x 500-sheet Tray (Trays 4 and 5)	Multibin Mailbox
Solid Green	The accessory is on and ready.	The accessory light is on and ready.
Solid Amber	The accessory is experiencing a hardware malfunction.	The accessory is experiencing a hardware malfunction.
Flashing Amber	The accessory has a paper jam or a page needs to be removed from the tray, even if the page is not jammed. The lower right door might be open.	The accessory has a paper jam or a page needs to be removed from the multibin mailbox, even if the page is not jammed. The accessory is not correctly attached to the printer.



LED Status Interpretation (continued)

<p>Off</p>	<p>The printer might be in Power Save mode. Press GO.</p> <p>The accessory is not receiving power. Check both the power supply and the power cables.</p>	<p>The printer might be in Power Save mode. Press GO.</p> <p>The accessory is not receiving power. Check both the power supply and the power cables.</p>
-------------------	---	---



Printer Software

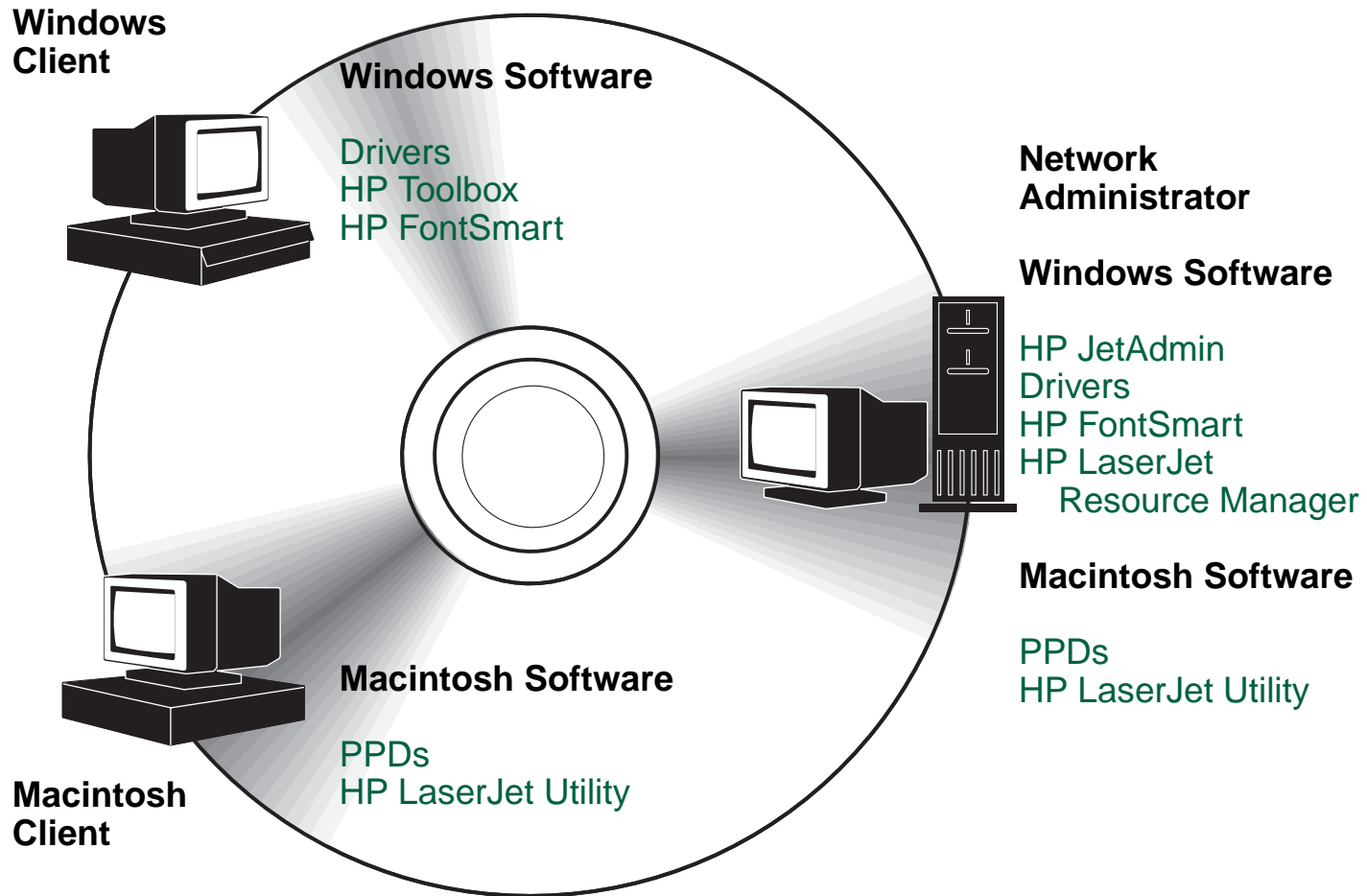

The printer drivers provided on the compact disc must be installed to take full advantage of the printer's features. The other software programs are recommended, but are not required for operation. See the ReadMe file for more information.



Note

Network Administrators: HP JetAdmin should be installed only on the network administrator's computer. Load all other applicable software on the server and all client computers.



The most recent drivers, additional drivers, and other software are available from the Internet. Depending on the configuration of Windows-driven computers, the installation program for the printer software automatically checks the computer for Internet access to obtain the latest software. If you do not have access to the Internet, see the [HP Support](#) pages at the front of this user guide to obtain the most recent software.



Included with the printer is a compact disc containing the HP LaserJet Printing System. On the compact disc are software components and drivers that benefit end users and network administrators. See the ReadMe file for the most current information.



The Printing System includes software designed for end users operating in the following environments:

- Microsoft Windows 3.1x



Continued on next page.



- Microsoft Windows 95
- Microsoft Windows NT 4.0
- IBM OS/2 version 2.0 or greater
- Apple Mac OS 7 or greater

Additional drivers for DOS WordPerfect 5.x and 6.x are available through your HP distributor. (See the [HP Support](#) pages at the front of this user guide.)

The Printing System also includes software for network administrators using the following network operating systems:

- Novell NetWare 3.x or 4.x
- Microsoft Windows NT 4.0
- IBM LAN Server 3.0 or greater
- Apple AppleTalk

Network administration software for UNIX and other network operating systems is available from the web, or through your HP distributor. (See the [HP Support](#) pages at the front of this user guide.)

The drivers and software components for end users and administrators using the environments listed above are described in the following sections.



Printer Drivers

Printer drivers access the printer features and allow the computer to communicate with the printer (via a printer language).

Windows

See [Access the Windows Printer Driver](#) on page [63](#) for more specific driver information.

Macintosh

See [PostScript Printer Description Files \(PPDs\)](#) on page [69](#) for more specific driver information.

Note

Check the ReadMe file provided on the compact disc for additional software included and supported languages.

Certain printer features are available only from the PCL 6 driver. See the printer software help for availability of features.

Continued on next page.



Drivers Included with the Printer

The following printer drivers are included with the printer. The most recent drivers are available on the Internet. (See the [HP Support](#) pages at the front of this user guide.) Depending on the configuration of Windows computers, the installation program for the printer software automatically checks the computer for Internet access to obtain the latest drivers.

	PCL 5e	PCL 6	PS
Windows 3.1x	✓	✓	✓
Windows 95	✓	✓	✓
Windows NT 4.0	✓	✓	✓
Macintosh computer	PPDs are included (page 69).		

Within the computer installation program, select **Typical Install** to install the PCL 5e, PCL 6, and PS drivers and HP FontSmart. Select **Custom Install** to install only the software you prefer, or if you are a network administrator. Select **Minimum Install** to install only the PCL 6 driver for basic printing.



Additional Drivers

You can obtain the following printer drivers by downloading them from the Internet, or by requesting them from an HP-authorized service or support provider. (See the [HP Support](#) pages at the front of this user guide.)

- OS/2 PCL/PCL 6 printer driver*
- OS/2 PS printer driver*
- WordPerfect 5.1 printer driver
- AutoCAD (Rev. 14 compatible printer driver, also available on the compact disc)

*The OS/2 drivers are also available from IBM, and are packaged with OS/2.

Note

If the desired printer driver is not on the compact disc or is not listed here, check the software application's installation disks or ReadMe files to see if they include support for the printer. If not, contact the software manufacturer or distributor and request a driver for the printer.



Software for Windows

Use the **Typical Install** option, or **Custom Install** option (if you are a Network Administrator), to install the HP software. (This includes several printer drivers. For more information, see page [56](#))

Note

Network Administrators: If the printer is attached to a network through an HP JetDirect EIO card, before you can print, the printer must be configured for that network using HP JetAdmin or similar network software. (See the getting started guide.)



Installing Windows Printing Software (CD)

For Windows 95 and Windows NT 4.0

1. Close all running applications.
2. Insert the compact disc into the CD-ROM drive. (Depending on the computer configuration, the installation program may automatically start.)
3. Click **Start**.
4. Click **Run**.
5. Type **D:\SETUP** (or the appropriate drive directory letter) in the command line box and click **OK**.
6. Follow the instructions on the computer screen.

Continued on next page.



For Windows 3.1x

Note Windows 3.1x includes only PostScript Level 2 Emulation (or Level 1 Emulation for Windows 3.1x) and FontSmart.

1. Close all running applications.
2. Insert the compact disc into the CD-ROM drive.
3. In the **Windows Program Manager** screen, click the **File** menu.
4. Click **Run**.
5. Type **D:\SETUP** (or the appropriate drive directory letter) in the command line box and click **OK**.
6. Follow the instructions on the computer screen.



Installing Network Software

Note If the printer is to be used on a network, install and configure the network operating system software on the network administrator's system before individual users install the printing software.

1. Select a Custom install to install the printing system software. Be sure to install the HP JetAdmin software.
2. Use HP JetAdmin to configure the HP JetDirect print server and the printer for your network. You also can use HP Web JetAdmin to configure your printer with your web browser. For information on using HP Web JetAdmin, see HP's web site at <http://www.hp.com>



Installing Macintosh Printing Software

1. Quit all open applications.
2. Insert the compact disc into the CD-ROM drive.
3. Double-click the **Installer** icon and follow the instructions on the screen.
4. Open the **Chooser** from the **Apple** menu.
5. Click the **Apple LaserWriter** icon. If the icon is not there, contact your Macintosh dealer.
6. If you are on a network with multiple zones, select the zone in the **AppleTalk Zones** box where the printer is located. If this is unknown, ask your network administrator.
7. Double-click the desired printer. An icon should appear.
8. Close the **Chooser** by clicking the Go-Away (Close) box in the upper left corner.



Access the Windows Printer Driver

To configure the driver once the software is installed, access it in one of the following ways:



Operating System	Temporarily Change Settings (from a software application)	Change Default Settings (across all applications)
Windows 95	From the File menu, click Print , and then click Properties . (The actual steps can vary; this is the most common method.)	Click the Start button, point to Settings , and then click Printers . Right-click the printer icon, and choose Properties .
Windows NT 4.0	From the File menu, click Print , and then click Properties . (The actual steps can vary; this is the most common method.)	Click the Start button, point to Settings , and then click Printers . Right-click and choose Document Defaults or Properties .
Windows 3.1x	From the File menu, click Print , click Printers , and then click Options . (The actual steps can vary; this is the most common method.)	From the Windows control panel, double-click Printers , highlight the printer, and click Setup .

Note

Settings in the printer driver and software application override control panel settings. (Software application settings override printer driver settings.)

Choose the Right Printer Driver for Your Needs

Choose a printer driver based on the way you use the printer.

- Use the PCL 6 driver to take full advantage of the printer's features. Unless backward compatibility with previous PCL drivers or older printers is necessary, the PCL 6 driver is recommended.
- Use the PCL 5e driver if you want print results to look comparable to those from older printers. Certain features are not available in this driver. (This PCL 5e driver is not backward compatible with older printers.)
- Use the PS driver for compatibility with PostScript Level 2 needs. Certain features are not available in this driver.
- The printer automatically switches between PS and PCL printer languages.



Printer Driver Help

Each printer driver has help screens that can be activated either from the Help button, the F1 key, or a question mark symbol in the upper right corner in the printer driver (depending on the Windows operating system used). These help screens give detailed information about the specific driver. Printer driver help is separate from the software application help.



HP ToolBox

HP ToolBox is enabled during a **Custom Install** and is not needed to print.

Access HP ToolBox from a printer icon on the Windows 95 and Windows NT 4.0 **Taskbar**. HP ToolBox provides one-step access to the current status of the printer and the jobs it is printing. A list of all available features is as follows:

- printer status
- “How Do I...” help
- utilities
- job status

If you choose not to use HP ToolBox, it can be disabled. See the printer software help.



HP FontSmart

Access HP FontSmart from the HP LaserJet folder or through HP ToolBox. HP FontSmart is a font management utility (for Windows only) which does the following:

- installs, uninstalls, and deletes fonts
- manages fonts inside a single window by allowing you to drag-and-drop
- shows the 110 matching screen fonts for the internal fonts in the printer
- downloads fonts to a mass storage device

Note

With Windows 3.1x and Windows 95, you can use HP FontSmart to download fonts to a mass storage device. Types of fonts supported are TrueType, PostScript® Type 1 and PostScript Type 42 (TrueType fonts converted to PostScript format). To download Type 1 fonts, Adobe Type Manager must be installed and turned on.



HP JetSend Communications Technology



HP JetSend can be installed through an installer on the compact disc. HP JetSend is a new technology from Hewlett-Packard that allows network devices to communicate with each other directly. Devices which contain the HP JetSend technology can exchange information directly with other devices connected via the Internet or intranet. Sending devices can include scanners and computers. Receiving devices can include printers and computers. In addition to sending and receiving documents, you can view documents using the HP JetView software.

HP JetSend technology enables flexible, direct communications between network devices using simple IP addressing. HP JetSend enables simple, targeted, information exchange that is independent of both servers and applications. This means that users can easily exchange information directly between Internet-connected devices like printers and scanners (and other devices in the future).

HP JetSend capabilities can be integrated into the Microsoft Windows environment. For example, using devices enabled with HP JetSend, you can capture a document with a scanner (or create a document using computer software) for distribution via the Internet to several users. Users can receive the document in their computer's InBox or print directly to their printer.



Software for Macintosh Computers

PostScript Printer Description Files (PPDs)

PPDs, in combination with the LaserWriter driver, access the printer features and allow the computer to communicate with the printer. An installation program for the PPDs and other software is provided on the compact disc. Use the LaserWriter printer driver that comes with the computer. (The LaserWriter driver is also available from Apple.)

HP LaserJet Utility

HP LaserJet Utility allows control of features that are not available in the driver. The illustrated screens make selecting printer features from the Macintosh computer easier than ever. Use the HP LaserJet Utility to do the following:

- Customize the printer's control panel messages.
- Name the printer, assign it to a zone on the network, download files and fonts, and change most of the printer settings.
- Set a password for the printer.
- From the computer, lock out functions on the printer's control panel to prevent unauthorized access. (See the printer software help.)

Continued on next page.



Fonts

80 screen fonts are installed that correspond with the 80 PS fonts resident in the printer.



Software for Networks

HP Web JetAdmin

This browser-based HP JetAdmin software can be installed on any supported server platform. The following systems are supported:

- Microsoft Windows NT
- HP-UX*
- IBM OS/2*
- Sun Solaris*

*HP Web JetAdmin is not included on the compact disc with the printer, but is available from the Internet. If you do not have access to the Internet, see the [HP Support](#) pages at the front of this user's guide to obtain this software.

Use HP Web JetAdmin to do the following:

- Install and configure printers that are connected to a network with an HP JetDirect print server.
- Manage and troubleshoot network printers from any location.



HP JetAdmin

HP JetAdmin is primarily for users who cannot use Web JetAdmin due to the lack of browser access or because none of the supported server platforms exist on their network. HP JetAdmin should be installed only on the network administrator's computer. HP JetAdmin can be accessed by clicking the **Start** button (point to **Settings**, and then click **Control Panel**) in Windows 95 and Windows NT 4.0 or from the HP LaserJet program group folder. Use HP JetAdmin to do the following:

- Install, configure, and manage printers that are connected to a network with an HP JetDirect print server.
- Manage and troubleshoot network HP printers and print servers.

The HP JetAdmin software works on the following network systems:

- Microsoft Windows NT
- Microsoft Windows 95
- Microsoft Windows 3.1x
- Novell NetWare
- HP-UX*
- Solaris*
- SunOS*
- IBM OS/2*



*The software for these systems is not included on the compact disc with the printer, but is available from the Internet. If you do not have access to the Internet, see the [HP Support](#) pages at the front of this user guide to obtain this software.



Note

Network Administrators: If the printer is attached to a network, before you can print, the printer must be configured for that network using HP JetAdmin or similar network software. (See the getting started guide.)



HP LaserJet Resource Manager

The HP LaserJet Resource Manager should be installed only on the network administrator's computer. The HP LaserJet Resource Manager allows you to control hard disk and flash memory features not found in the drivers.

Use the HP LaserJet Resource Manager to do the following:

- Initialize disk and flash memory.
- Download, delete, and manage fonts to disk and flash memory across networks.
 - ◆ PostScript Type 1, PostScript Type 42 (True Type fonts converted to PostScript format), TrueType, and PCL bitmap fonts.

Note

To download Type 1 fonts, Adobe Type Manager must be loaded and turned on.



2 *Printing Tasks*

Overview

This chapter presents **basic printing tasks**, such as:

- [Selecting the Input Tray](#)
- [Selecting the Output Bin](#)
- [Using the Stapler](#)
- [Printing Both Sides of Paper \(Optional Duplex Printing Accessory\)](#)
- [Printing Envelopes](#)
- [Printing Special Paper](#)



Selecting the Input Tray

Loading Tray 1

CAUTION

To avoid a paper jam, never add or remove paper from Tray 1 while the printer is printing.

To avoid damaging the printer, print labels and transparencies only from Tray 1. Send them to the Left Output Bin, and do not print them on both sides.

When printing multiple transparencies, promptly remove each transparency as soon as it emerges from the printer (so the sheets do not stick together).

- 1 Open Tray 1.
- 2 Pull out the tray extension, if needed for the paper size you are printing.

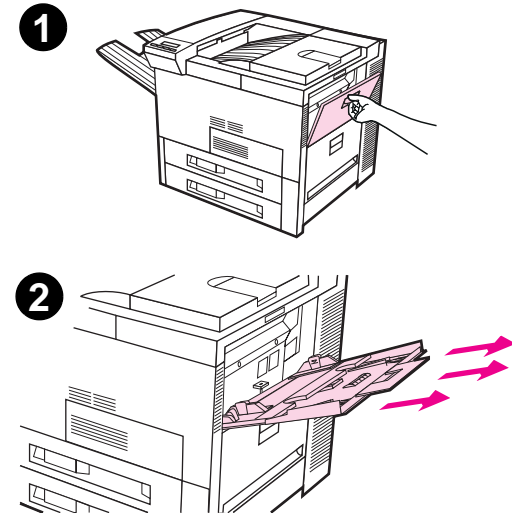

- 3 Slide the paper width guides to the appropriate size marked on the tray.
- 4 Place paper into the tray without stacking it above the paperfill mark.

Note

For single-sided printing, place paper into the tray with side-to-be-printed up. The top of the letterhead should be toward the printer. For two-sided printing, place paper with the front side down. The top of the letterhead should be toward the printer. For prepunched paper, always load with the holes toward the printer.

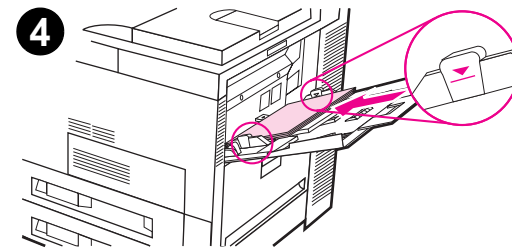
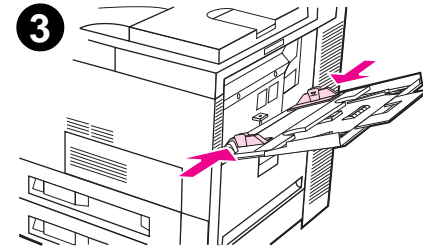

- 5 Paper loading differs by size:
- a. Load Letter and ISO A4 with the longer edge of the page leading into the printer.
 - b. Load envelopes, Executive, Legal, 11 x 17, ISO A3, JIS B5, or JIS B4 with the short edge of the page leading into the printer. (For more information on paper specifications, see page [256](#).)

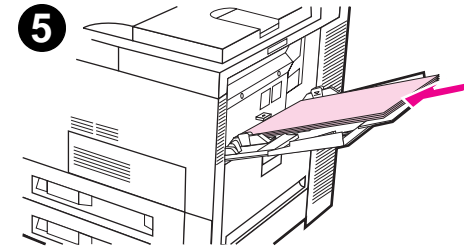

- 6 Slide the paper into the printer until paper fits squarely and firmly between the paper width guides, without bending.

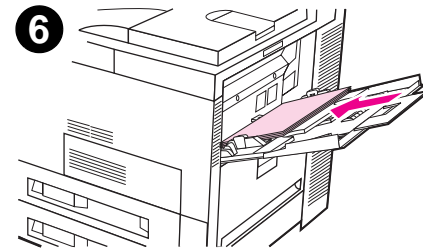

Note

Paper heavier than 28 lb (105 g/m²) should be printed from Tray 1 to the Left Output Bin to avoid curl.

If Tray 1 is in CASSETTE mode, the printer Attention light will flash. Press - VALUE + to change the size to match the paper size in Tray 1 and press SELECT.



Loading Trays 2, 3, and the Optional 2 x 500-sheet Input Tray (Trays 4 and 5)

- 1 Open the tray until it stops.
- 2 Turn the paper guide lock to the unlocked position.
- 3 Slide the paper guide to the mark that indicates the size of paper you are loading.

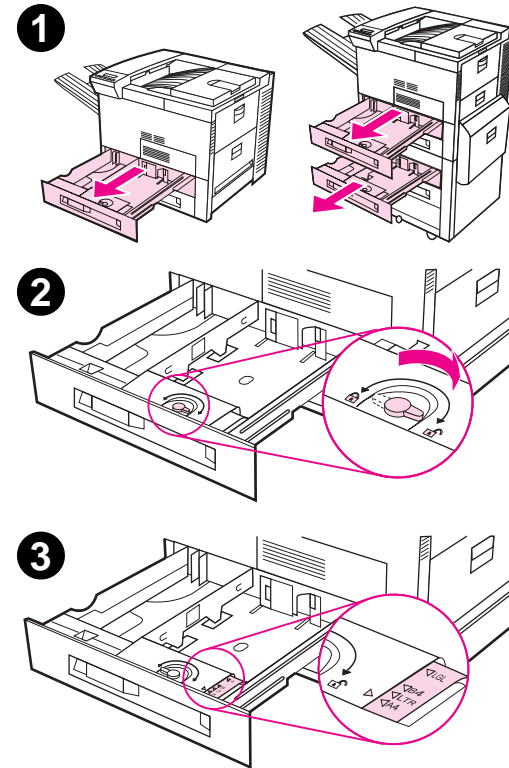

- 4 Turn the paper guide lock to the locked position.
- 5 Adjust the left paper guide by pushing in, then lifting up and out.
- 6 Position the guide over the appropriate lines marked in the tray. Press the guide into the rear slot and then lower down into the front slot. Be sure the guide is not skewed.

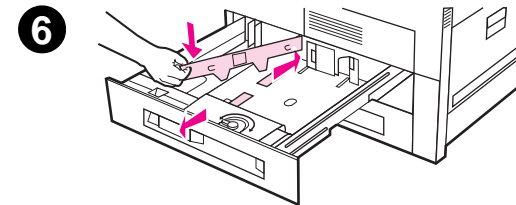
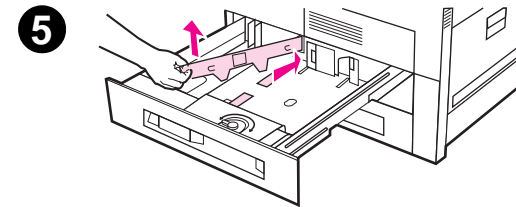
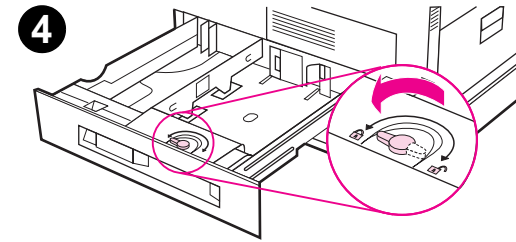

- 7 Insert up to 500 sheets of paper into the tray. Do not fill the input tray above the paper fill marks on the guides.

Note

For single-sided and double-sided printing, place paper into the tray with the side-to-be-printed down. The top of the letterhead should be toward the rear of the tray.

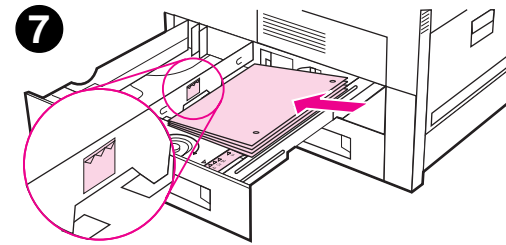

- 8 Ensure that the paper size tab is set correctly. Slide the tray back into the printer.
- 9 If you wish to select your paper by type rather than tray (source), see page [134](#).

Adjust the paper stop guide on the Standard Output Bin for paper sizes larger than Letter or A4. See page [91](#).

Note

If paper curls or skews excessively during printing, open the tray and turn the stack of paper over. To avoid a paper jam, never open the tray while it is in use.

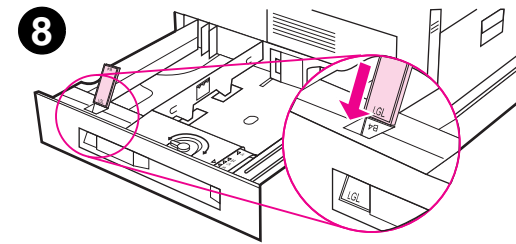

Loading the Optional 2000-sheet Input Tray (Tray 4)

An optional 2000-sheet Input Tray (Tray 4) is available for the printer. The tray fits under the printer, and acts as a base. For paper specifications, see page [254](#).

Continued on next page.



Selecting the Input Tray

- 1 Slide Tray 4 open until it stops.
- 2 Pull the front guide out by the blue pin. Place the guide into the slots in the top and bottom of the input tray that correspond to the paper size you are loading and push in the pin.
- 3 Repeat step 2 to adjust the back guide.
- 4 Repeat step 2 to adjust the left guide.

Note

To load 11 by 17 inch paper, move the left guide to the back of the tray.

Continued on next page.

1

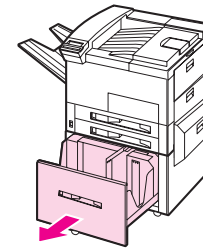

2

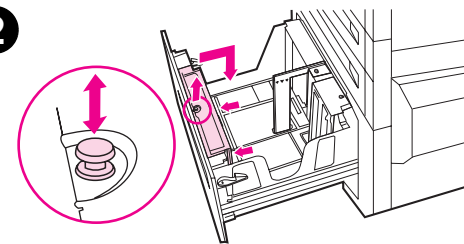

3

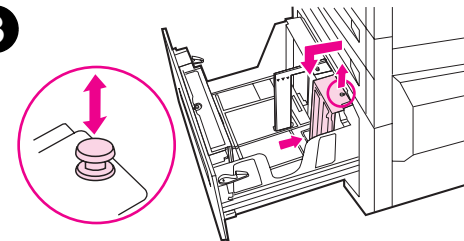

4

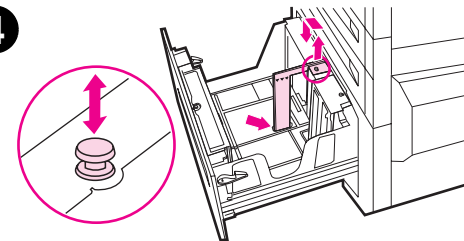

Load up to 2000 sheets of paper into the tray. Do not allow paper to extend above the paperfill mark on the sides.

- 5 Load Letter or A4 paper with the top of the page toward the rear of Tray 4, side-to-be-printed down (A) for single-sided printing. For two sided printing, load front side up.
- 6 Load 11 x 17, Legal, A3, or JIS B4 paper with top of the page toward the right of the printer. For two sided printing, load front side up (B).

5

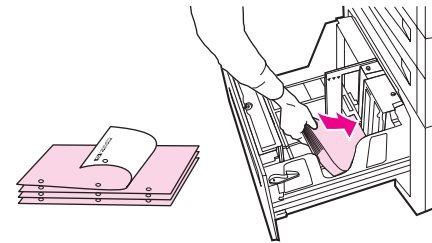

6

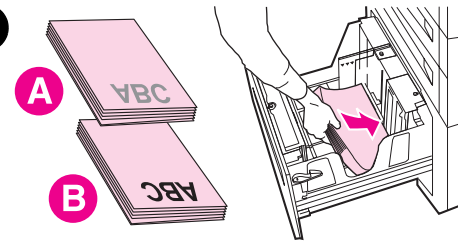

- 7 Press down on all four corners of the paper stack to ensure the paper rests flat in the tray, without bending.
- 8 Close Tray 4.
- 9 Ensure that the paper size tab is set correctly.

Note

See [Printing by Type and Size of Paper](#) on page [134](#) to set the type of paper you loaded in the tray.

If using the Standard Output Bin, remember to adjust the paper stop guide on the output bin. See page [91](#).

7

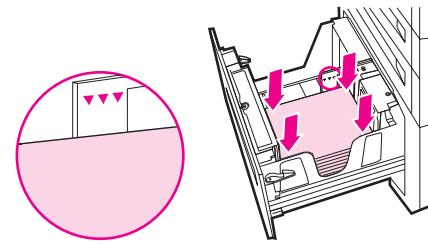

8

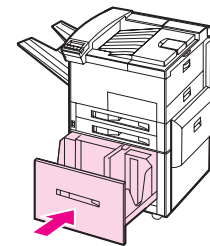

9

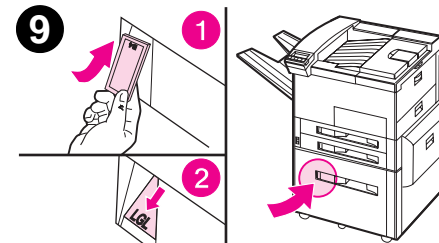

Selecting the Output Bin

The printer has several output locations: the Standard Output Bin, the Left Output Bin, and the optional Mailboxes (the 7-bin Tabletop Mailbox, the Multibin Mailbox (8 bins), and the 5-bin Mailbox with Stapler).

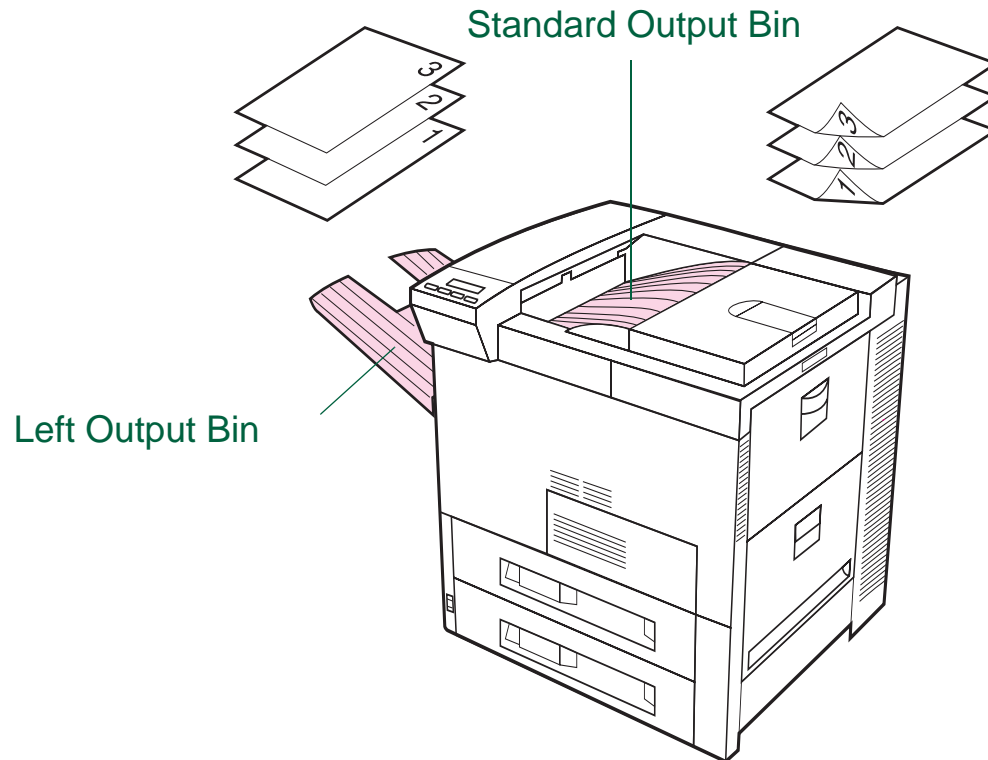

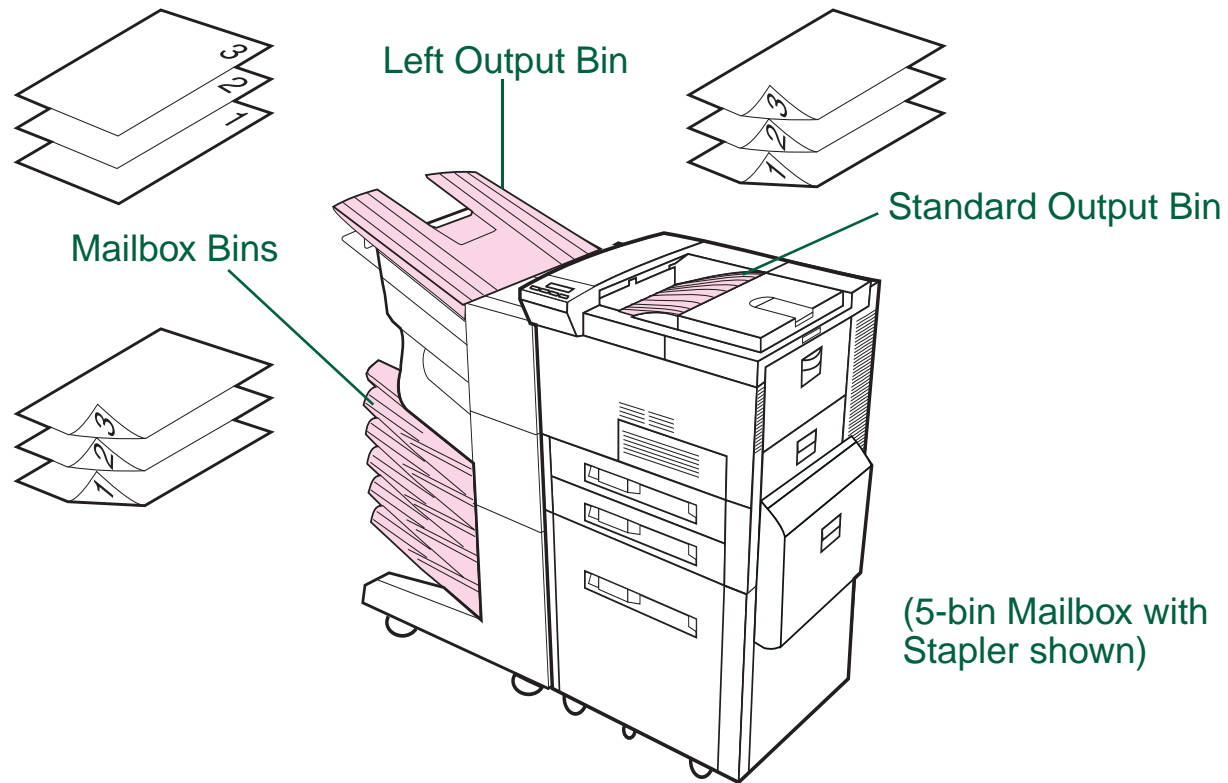

Note For best results, use the Left Output Bin to print envelopes, labels, or transparencies.

Selecting the Output Bin

Printing to the Standard Output Bin

The Standard Output Bin, located at the top of the printer, holds up to 500 sheets of paper in the correct order as they exit the printer. A sensor causes the printer to stop when the paper bin is full. Printing continues when you empty or reduce the amount of paper in the bin. The Standard Output Bin is the factory default bin.



Selecting the Output Bin

Adjusting the Paper Stop

The paper stop, illustrated below, is located near the Standard Output Bin. It can be adjusted to help paper lay flat as it exits the printer. The paper stop does not have to be raised for Letter or A4 size paper. Note that the printer jams if the paper stop is set to a smaller size of paper than is being printed.

1. Pull the left side of the paper stop up until the stop is in an upright position.
2. Slide the paper stop to the mark indicating the largest paper size to be printed.

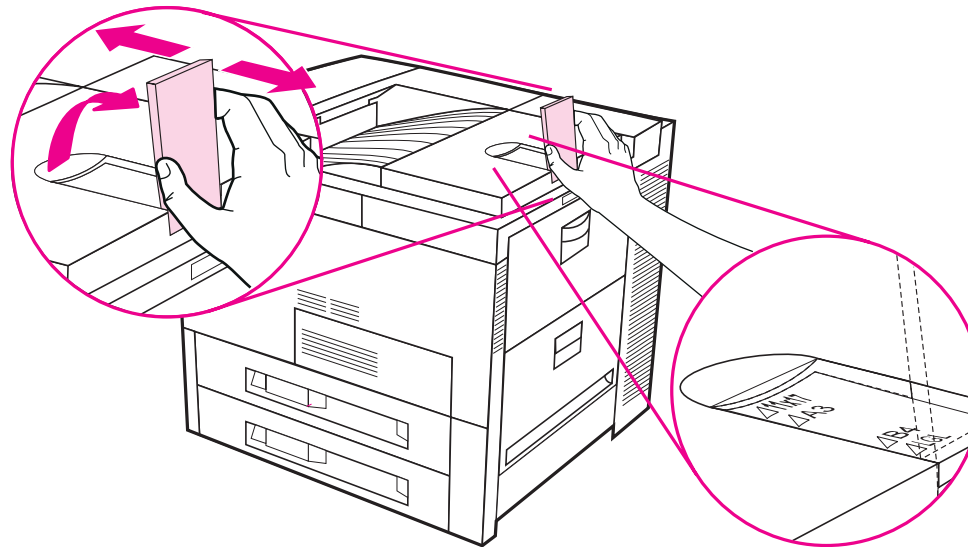

Printing to the Left Output Bin

The Left Output Bin, located on the upper left side of the printer, holds up to 125 sheets of paper face up as they exit the printer. This bin is mainly used for special paper types, such as labels, envelopes, or transparencies, that cannot tolerate the curved paper path of the Standard Output Bin. This output bin does not sense when the bin is full.

You can select an output bin through your software application, printer driver, or from the printer control panel.



Selecting the Output Bin

Printing to a Mailbox

The following Mailboxes are available for the printer:

- 7-bin Tabletop Mailbox (each bin holds up to 120 sheets of paper)
- Multibin Mailbox (8 bins, each bin holds up to 250 sheets of paper)
- 5-bin Mailbox with Stapler (each bin holds up to 250 sheets of paper)

These mailboxes attach to the left side of the printer. They can work in one of the following modes:

Modes

Mailbox	Each bin can be addressed individually as the output destination, and can have a name assigned to it by the network or printer administrator.
Collator	In this mode, the device automatically separates mopies. Each mopy is delivered in consecutive bins, starting from the Left Output Bin. In this case, one job contains several mopies.
Job Separation	Automatically separates incoming jobs, assigning a bin to each job, which may include multiple copies. It uses all mailbox bins for this purpose, but is seen in the printer software as one logical bin. If a mailbox bin is full, the printer automatically sends the job to the next available bin if selected in JetAdmin.



Selecting the Output Bin

Modes (continued)**Stacking**

This mode stacks the printed output from the lowest bin to the top, regardless of job boundaries. This mode of operation takes advantage of the total capacity of the mailbox bins. The device is seen by the software as one logical bin.

***How to Configure the Operating Modes***

The network or printer administrator chooses the mode of operation through an HP network configuration utility, such as HP JetAdmin or HP LaserJet Utility. You will need to set up your printer driver to reflect the mode chosen by the administrator.

Bidirectional Environment

The printer automatically selects the mode established by the network administrator.

Nonbidirectional Environment

You can change the mode in the driver. The method for changing the mode varies with driver and by operating system. Refer to your driver's online help.

The printer control panel will display different messages depending on the mailbox used and which mode you are using. See the printer software help for more information.

***Selecting the Output Bin***

Mailbox Mode

	In Mailbox Mode, if the Control Panel says:	Then the physical location is:
5-bin Mailbox with Stapler	OPTIONAL BIN 1	Left Output Bin
	OPTIONAL BIN 2 through 6	Mailbox 1-5
	OPTIONAL BIN 7	Stapler Bin
7-bin Tabletop Mailbox	OPTIONAL BIN 1	Left Output Bin
	OPTIONAL BIN 2 through 8	Mailbox 1-7
Multibin Mailbox (8 bins)	OPTIONAL BIN 1	Left Output Bin
	OPTIONAL BIN 2 through 9	Mailbox 1-8



Job Separation, Collator, and Stacking Modes

	In Job Separation, Collator, and Stacking Modes, if the Control Panel says:	Then the physical location is:
5-bin Mailbox with Stapler	OPTIONAL BIN 1	Left Output Bin
	OPTIONAL BIN 2	Mailbox 1-5
	OPTIONAL BIN 3	Stapler Bin
7-bin Tabletop Mailbox	OPTIONAL BIN 1	Left Output Bin
	OPTIONAL BIN 2	Mailbox 1-7
Multibin Mailbox (8 bins)	OPTIONAL BIN 1	Left Output Bin
	OPTIONAL BIN 2	Mailbox 1-8

Note The Mailboxes handle all of the printer's supported paper sizes (page [256](#)). Envelopes, labels, and transparencies should only be sent to the Left Output Bin.

The stapler is located on the left side of the 5-bin Mailbox with Stapler. The stapler can staple jobs of 2 to 20 sheets on 20 lb. paper. The stapler bin can hold a maximum of 350 sheets. Only jobs sent to the stapler bin will be stapled.

Selecting the Output Bin



Selecting a Mailbox through the Software

You can select mailboxes through your software application, printer driver, or from the printer control panel. Otherwise, follow the instructions below for setting the overall default printer output bin selection. Where and how you make selections depends on your software application or associated printer driver. (Some options may only be available through the printer driver.)

Selecting Mailboxes from the Control Panel

1. Press **MENUS** repeatedly until `PAPER HANDLING` appears.
2. Press **ITEMS** repeatedly until `PAPER DEST= STANDARD OUT BIN *` appears.
3. Press **+** repeatedly until `PAPER DEST= OPTIONAL BIN x` appears. The `x` represents a number that varies depending upon the mailbox selected and the operating mode used. Your network administrator may have changed these names.
4. Press **SELECT** to save your choice. An asterisk (*) appears next to your selection.



Using the Stapler

Loading Staple Cartridges

- 1 Turn off the printer and remove the Left Output Bin.
- 2 Open the stapler unit cover.
- 3 Squeeze the stapler cartridge tabs together and pull the empty staple cartridge out.

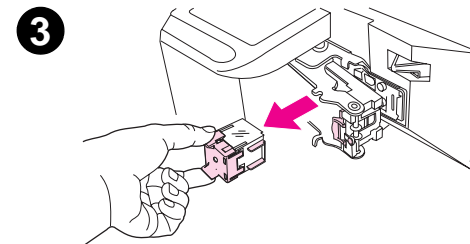
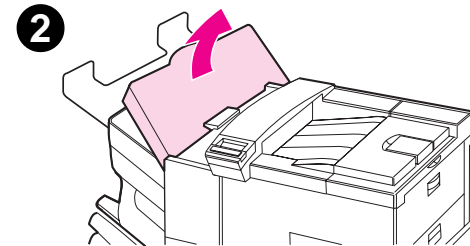
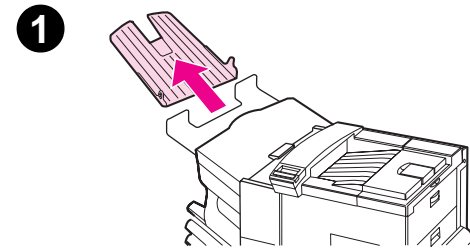

- 4 Remove the plastic shipping clip from the new staple cartridge. Insert the new staple cartridge so that it snaps into place.
- 5 Close the stapler unit cover, replace the Left Output Bin, and turn the printer on.

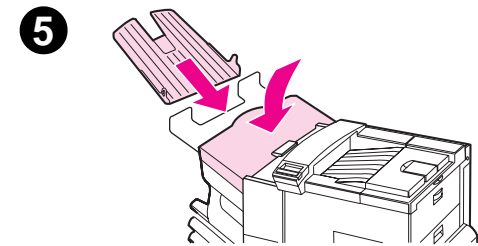
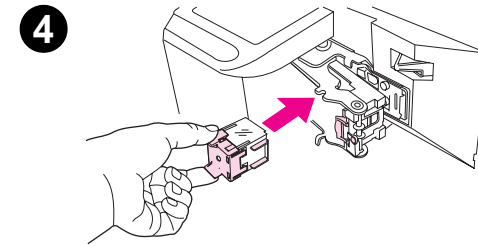

Stapling Documents

The stapler can staple documents of 2 to a maximum of 20 pages on 16 to 28 lb paper, Letter, Legal, and A4 size only. For paper beyond 20 lb, fewer sheets can be stapled depending upon the weight of the paper. The stapler should not be set as the default output bin. If your job is only one page, or if it is greater than 20 pages, the printer will print your job to the bin, but it will not be stapled. The stapler bin can hold up to 350 stapled sheets. To have your job stapled, send it to `OPTIONAL BIN x`. See pages [95](#) and [96](#) to choose the appropriate bin according to the mode you are using.

Selecting the Stapler through the Software

You can select the stapler through your software application or printer driver. This is the recommended method for stapling. If you are unable to designate the paper destination in your software or printer driver, follow the instructions below for setting the overall default printer output bin selection. Where and how you make selections depends on your software application or associated printer driver. (Some options may only be available through the printer driver. See page [55](#) for more information on accessing the printer driver.)



Selecting the Stapler from the Control Panel

If your software does not support stapling, set it using the directions below.

1. Press **MENUS** repeatedly until `PAPER HANDLING` appears.
2. Press **ITEMS** repeatedly until `PAPER DEST= STANDARD OUT BIN *` appears.
3. Press **+** repeatedly until `PAPER DEST= OPTIONAL BIN x` appears. (See pages [95](#) and [96](#) to choose the appropriate bin according to the mode you are using.) Your network administrator may have changed the name of this bin. For example, it may be called `STAPLER`.
4. Press **SELECT*** to save your choice. An asterisk (*) appears next to your selection.



Printing Both Sides of Paper (Optional Duplex Printing Accessory)

The printer can automatically print on both sides of paper with an optional duplex printing accessory (duplexer). This is called duplexing.

Note

See the documentation included with the duplexer for complete installation and setup instructions. Duplexing might require additional memory (page [310](#)).

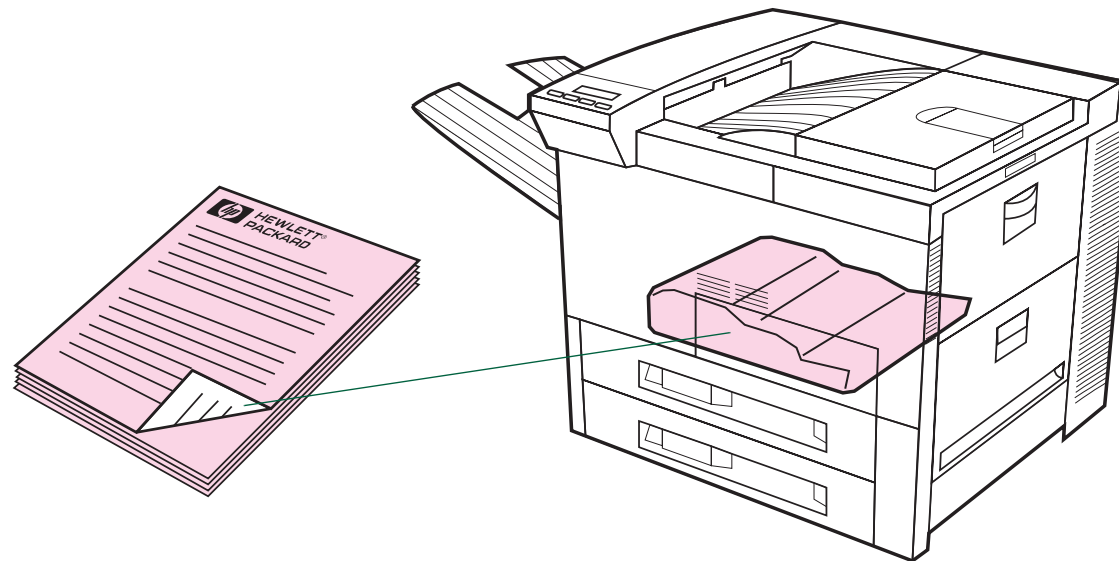

Guidelines for Printing Both Sides of Paper

CAUTION

Do not print on both sides of labels, transparencies, envelopes, or paper heavier than 28 lb (105 g/m²). Damage to the printer and paper jamming might result.

- You might need to configure the printer driver to recognize the duplexer. (See the printer software help for details.)
- To print on both sides of paper, make the selection from the software or printer driver. (See the printer software help.)
- If the printer driver does not have this option, change the Duplex setting from the Paper Handling Menu in the printer's control panel to DUPLEX=ON. Also in the Paper Handling Menu, set Binding to long edge or short edge. (For more information, see page [106](#).)



Paper Orientation for Printing Both Sides of Paper

The duplexer prints the second side of paper first, so paper such as letterhead and preprinted paper needs to be oriented as shown.

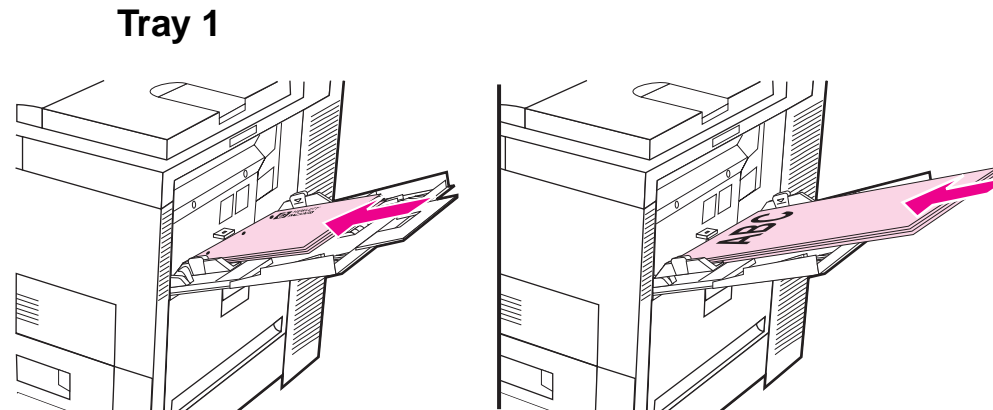

- Load letter and A4 paper with the side-to-be-printed facing up, and the top, short edge toward the back.
- Load other sizes of paper with the side-to-be-printed facing up, and the top, short edge toward the printer.

Continued on next page.



All other trays

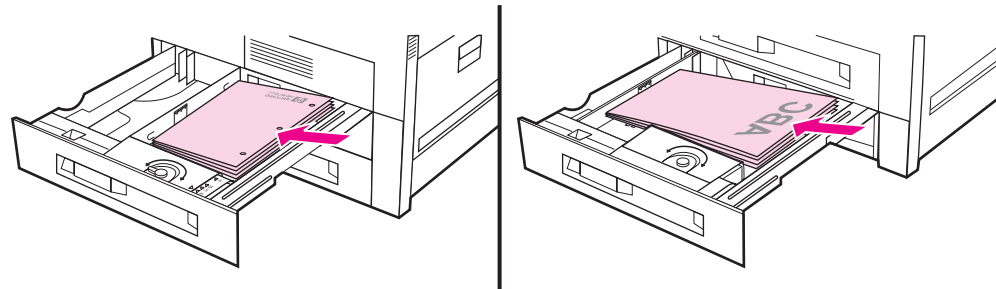

- Load letter and A4 paper with the side-to-be-printed facing down, and the top, short edge toward the back.
- Load other sizes with the side-to-be-printed facing down, and the top, short edge toward the right of the tray.



Layout Options for Printing Both Sides of Paper

The four print orientation options are shown below. These options can be selected from the printer driver or from the printer's control panel (set BINDING from the Paper Handling Menu and ORIENTATION from the Printing Menu).

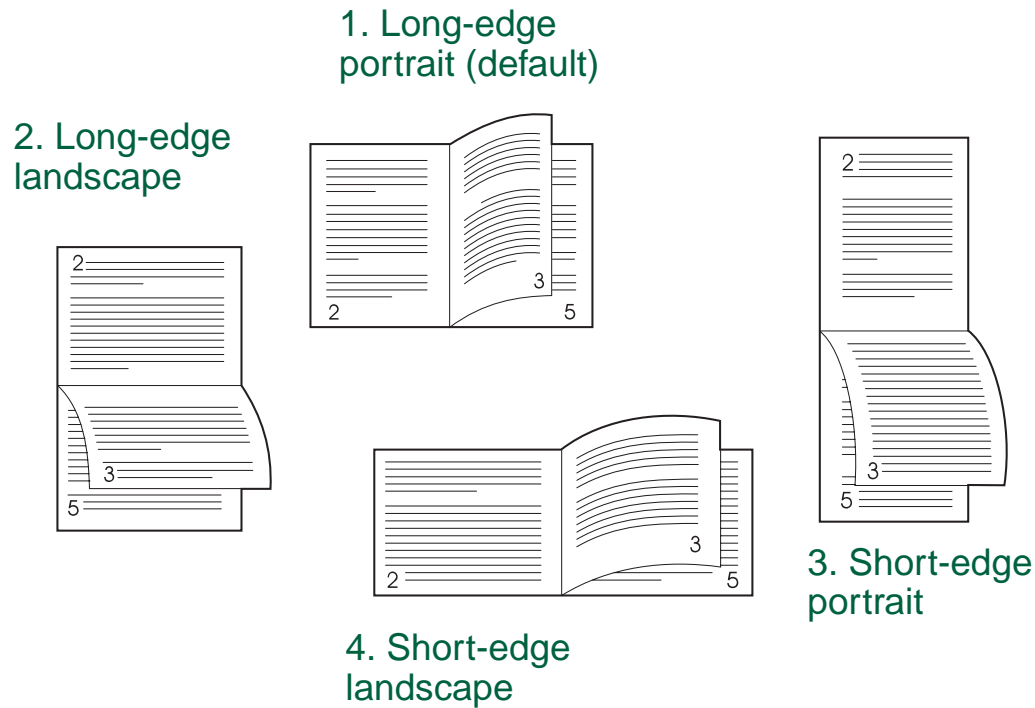

Printing Envelopes

Feeding Envelopes Automatically (Optional Envelope Feeder)

With the optional envelope feeder, the printer will automatically feed up to 100 envelopes. (For supported envelope sizes, see page [256](#).) To print envelopes without an envelope feeder, see page [111](#).

Note See the documentation included with the envelope feeder for complete installation and setup instructions.

You might need to configure the printer driver to recognize the envelope feeder. See the printer software help for details.

Continued on next page.



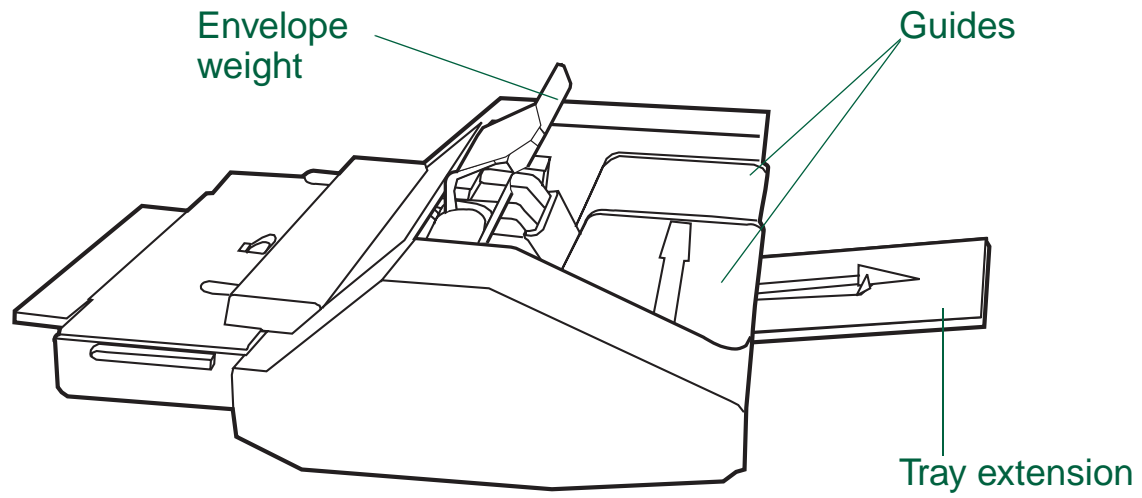

Inserting the Envelope Feeder

- 1 Open Tray 1 and remove the cover over the opening for the envelope feeder.
- 2 Locate the pins on the envelope feeder and the corresponding holes on the printer.
- 3 Align the envelope feeder with the corresponding printer rails.
- 4 Slide the envelope feeder into the printer until it locks into place.

1

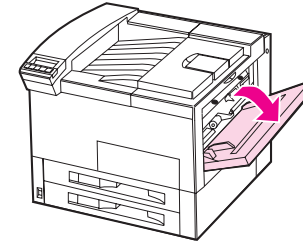

2

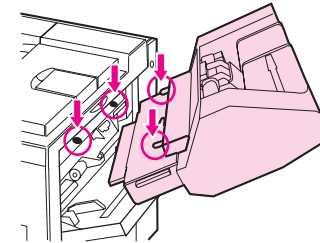

3

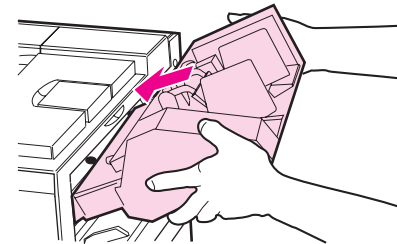

4

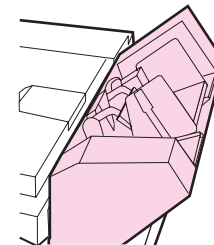

Loading Envelopes into the Envelope Feeder

Note

Print only envelopes approved for use in the printer (page [267](#)).

- 1 Pull out the envelope tray extender. The tray extender will help reduce jams.
- 2 Adjust the width guides to the size of the envelopes to be used.
- 3 Lift the envelope weight lever, and insert the envelopes up to the fill mark.
- 4 Lower the lever. The envelopes should be angled as shown (A). Do not angle them the opposite direction (B).

Note

Select the envelope size from the software application (if the setting is available), the printer driver, and the Paper Handling Menu in the printer's control panel (page [283](#)). To print by type and size of paper, see page [134](#).

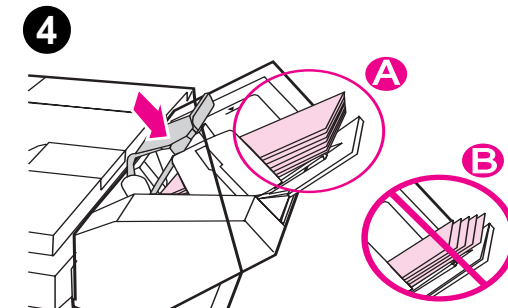
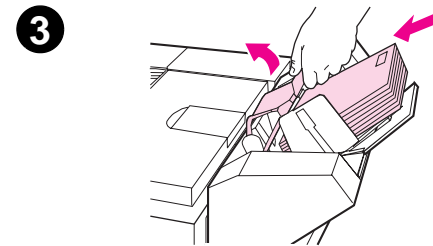
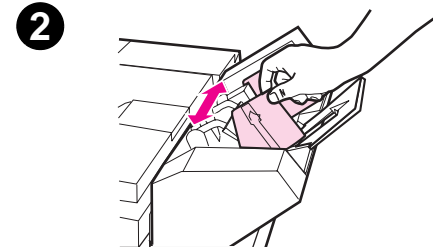
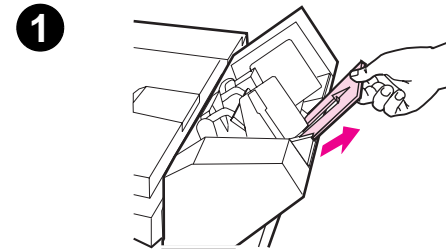

Printing Envelopes from Tray 1

With the optional envelope feeder, the printer will automatically feed up to 100 envelopes. To order an envelope feeder, see page [36](#). To print with the envelope feeder, see page [107](#).

Many types of envelopes can be printed from Tray 1. (Up to 10 can be stacked in the tray.) Printing performance depends on the construction of the envelope. Always test a few sample envelopes before purchasing a large quantity.

- Set margins at least 0.6 in. (15 mm) from the edge of the envelope.

WARNING! Never use envelopes with coated linings, exposed self-stick adhesives, or other synthetic materials. These items can emit noxious fumes.

CAUTION Envelopes with clasps, snaps, windows, coated linings, exposed self-stick adhesives, or other synthetic materials can severely damage the printer.

To avoid jamming and possible printer damage, never try to print on both sides of an envelope.

Before you load envelopes, make sure they are flat and not damaged or stuck together. Do not use envelopes with pressure-sensitive adhesive. (For envelope specifications, see page [267](#).)



Loading Envelopes in Tray 1

- 1 Open Tray 1.
- 2 If necessary, pull out the tray extension for the envelope size you are printing.
- 3 Place up to ten envelopes between the paper width guides, face up, with the back flap lying against the rear paper guide.
- 4 Slide the paper width guides until they lightly touch both sides of the envelope stack without bending it.

Note

Paper heavier than 28 lb (105 g/m²) should be printed from Tray 1 to the Left Output Bin to avoid curl.

If Tray 1 is in CASSETTE mode, the printer Attention light will flash. Press - **VALUE** + to change the size to match the paper size in Tray 1 and press **SELECT**.

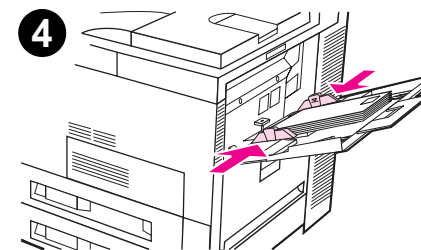
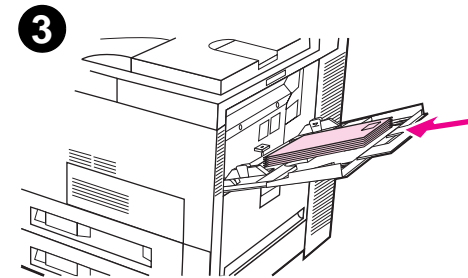
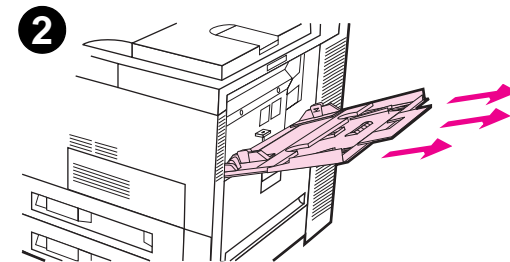
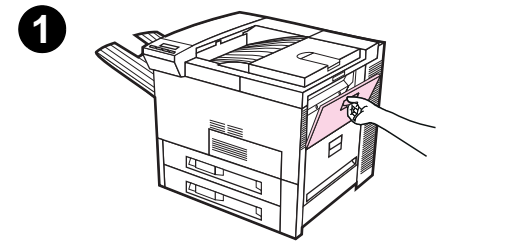

Printing Envelopes from Your Software Application

- 1 Load up to ten envelopes into Tray 1.
- 2 Specify Tray 1, Automatic, or select the paper source by type in your software application, and set the envelope size and type to the appropriate envelope size (page [267](#)).
- 3 If your software does not automatically format an envelope, specify Landscape for page orientation in your application.

CAUTION To avoid a printer jam, do not remove or insert an envelope once you begin printing.

For best print quality, use the following table to set margins for a return and mailing address. It gives you typical address margins for a Commercial #10 or DL envelope. Avoid printing over the area where an envelope's three back flaps meet.



Printing Special Paper



Printing Letterhead or Preprinted Paper

Special paper includes letterhead, envelopes, labels, transparencies, full-bleed images, rotated paper, postcards, custom-size, and heavy paper.



When printing letterhead or preprinted paper, it is important to load the trays with the correct orientation.



Note Paper orientation can differ when you print with an optional duplexer (page [104](#)).

Printing in portrait or landscape mode is usually selected from the software application or printer driver. If the option is not available, change the Orientation setting from the Printing Menu in the printer's control panel (page [290](#)).



Printing Labels

Use only labels recommended for use in laser printers. Make sure that labels meet the specifications for the input tray you use ([page 265](#)).

Do:

- Print a stack of 50 labels from Tray 1.
- Load labels with the side-to-be-printed facing up, and the top, short edge toward the back, if they are letter or A4 size. For other sizes, see [page 104](#).
- Use the Left Output Bin for printing labels.

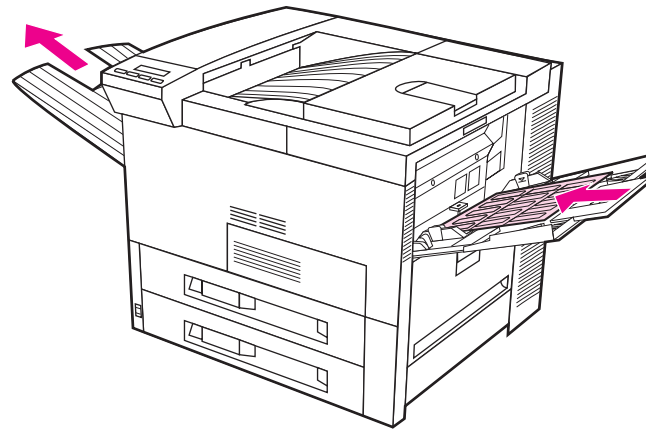

Continued on next page.



Do not:

CAUTION Failure to follow these instructions can damage the printer.

- Do not load the trays to capacity because labels are heavier than paper.
- Do not use labels that are separating from the backing sheet, wrinkled, or damaged in any way.
- Do not use labels that have the backing sheet exposed. (Labels must cover the entire backing sheet with no exposed spaces.)
- Do not feed a sheet of labels through the printer more than once. The adhesive backing is designed for only one pass through the printer.
- Do not print on both sides of labels.
- Do not send labels to a mailbox.



Printing Transparencies

Overhead transparencies used in HP LaserJet printers must be able to withstand the 392°F (200°C) temperature encountered in the printer's fusing process.

Use only transparencies recommended for use in laser printers. Because transparencies tend to stick to each other, remove each transparency from the output bin before printing the next one.

Use the Left Output Bin for printing transparencies.

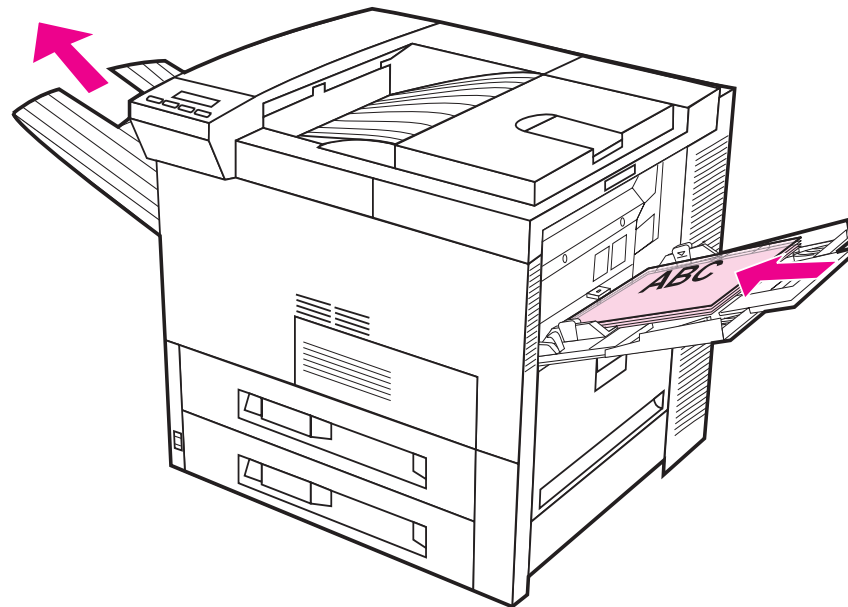

Custom-size Paper in Tray 1

You can print on custom-size paper from Tray 1. For paper specifications, see page [256](#).

Printing on the Smallest-Sized Paper

If you are using the printer driver to set the paper size, under the **Custom** button, select the paper tab and set the paper size.

Some software applications require you to calculate margins in order to print on custom-size paper. The following example is provided as a guideline. Adapt this example to your paper size and unit of measurement.

- 1 In your software application, select **Tray 1** for the paper source and **Maximum** (Windows PCL) or **Oversize** (Macintosh and Windows PS) for the paper size.

1 Paper Source: 

Paper Size: 



2 Calculate margins to identify the area to be printed. Illustration 2 and the steps below show how to calculate a margin for 3.67 by 7.5 in. (93 by 191 mm) paper.

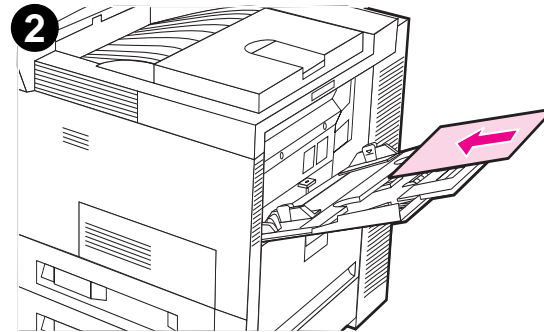

- a. Take the maximum paper width size 11.7 in. (297 mm) and subtract 3.67 in. (93 mm) for the width of the paper. Take the answer, 8.1 in. (204 mm), and divide it by 2, which equals 4.1 in. (102 mm).

In your software application, select a left margin of 4.1 in. (102 mm) and a right margin of 4.1 in. (102 mm).

- b. If your software allows, also set the bottom margin. Take the maximum paper length size, 17.7 in. (450 mm), and subtract 7.5 in. (191 mm), the length of the paper. The bottom margin equals 10.2 in. (259 mm).



- 3 Print custom-size paper from Tray 1. See [“Loading Tray 1”](#) on page [76](#).
- 4 The edge of the paper feeding into the printer must be at least 3.67 in. (93 mm) wide to allow rollers inside the printer to grab the paper. Measuring from the leading edge to the trailing edge of the paper, the length must be at least 7.5 in. (190 mm).

Note

For more information on paper specifications, see page [256](#).

Printing Bleeds

Since the printer has the ability to print on specially cut paper up to 11.7 by 17.7 in. (297 by 450 mm), you can print up to 11 by 17 in. (279 by 432 mm) bleed images with crop marks. Refer to your software application or online help.

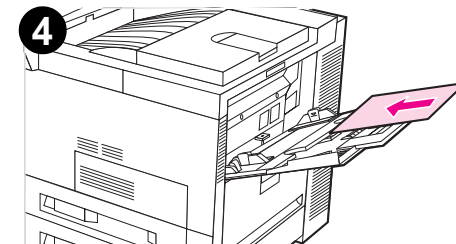
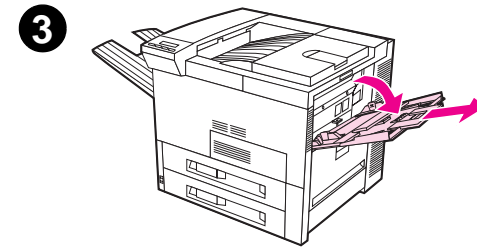

Printing Cards, Custom-size and Heavy Paper

Custom-size paper can be printed from Tray 1. For paper specifications, see [Paper Specifications](#) starting on page [254](#).

Note The printer's control panel can be set for one custom size at a time. Do not load more than one size of custom paper into the printer.



Guidelines for Printing Custom-size Paper

- Do not attempt to print on paper smaller than 3.67 inches (93 mm) wide or 7.5 inches (191 mm) long.
- Set page margins at least .17 inch (4.23 mm) away from the edges.

Setting Custom Paper Sizes

When custom paper is loaded, size settings need to be selected from the software application (the preferred method), the printer driver, or from the printer's control panel.

Note

Settings in the printer driver and software application override control panel settings. (Software application settings override printer driver settings.)

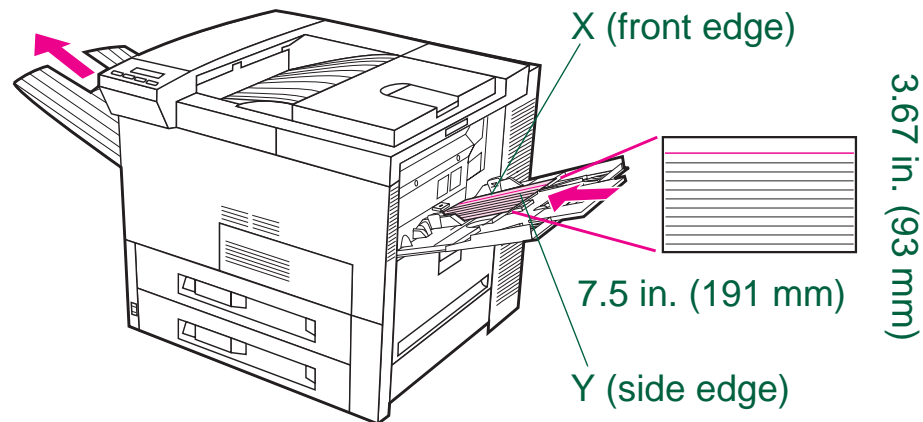

Continued on next page.



If the settings are not available from the software, set the custom paper size from the control panel:

1. From the Printing Menu set `CONFIGURE CUSTOM PAPER=YES`.
2. From the Printing Menu, select inches or millimeters as the unit of measurement.
3. From the Printing Menu, set the X dimension (the front edge of the paper) as shown in the illustration above. X can be from 3.67 to 11.7 in. (from 93 to 297 mm) for Tray 1. Set the Y dimension (the side edge of the paper) as shown in the illustration above. Y can be from 7.5 to 17.7 in (from 191 to 450 mm) for Tray 1.
4. If custom paper is loaded into Tray 1 and `TRAY 1 MODE=CASSETTE`, then set `TRAY 1 SIZE=CUSTOM` from the Paper Handling Menu in the printer's control panel. See ["Customizing Tray 1 Operation"](#) on page 131.
5. In the software, select **Custom** as the paper size.

For example, if the custom paper is 8 by 10 inches (203 by 254 mm), set X=8 inches and Y=10 inches (X=203 millimeters and Y=254 millimeters).

The X and Y dimensions must be set in the Configure Custom Paper Setting of the Printing Menu if the PCL 5e driver is used, or custom paper is loaded long-edge first (X is longer than Y).



3 *Advanced Printing Tasks*



Overview

This chapter introduces some **advanced printing tasks** to help you take full advantage of the printer's features. These tasks are "advanced" because they require you to change settings from a software application, the printer driver, or the printer's control panel.

- [Using Features in the Printer Driver](#)
- [Different First Page](#)
- [Customizing Tray 1 Operation](#)
- [Printing by Type and Size of Paper](#)

Note

Only use PCL 5e for backward compatibility. Most of the features in this section do not apply to PCL 5e. We recommend the use of PCL 6 or PostScript Emulation to take best advantage of the features in this printer.

Not all features are compatible with all drivers.



Using Features in the Printer Driver

When you print from a software application, many of the printer's features are available from the printer driver. To access Windows printer drivers, see page [63](#).

Note HP PCL 5e, PCL 6, PS, and Macintosh drivers are slightly different. Check the drivers for available options. The PCL 6 driver takes full advantage of the printer's features.

Settings in the printer driver and software application override control panel settings. (Software application settings override printer driver settings.)

Printer Collation

The Printer Collation feature allows multiple original prints (mopying) which provides you the following advantages:

- Reduces network traffic
- Faster return to application
- All documents are original

Continued on next page.



RIP ONCE

RIP ONCE allows the print job to be processed one time at the printer. The formatted print job can then be printed multiple times without pausing to process the print job again. This feature is normally active. To disable this feature you must turn off collation at the printer driver or in the control panel menu.

Saving Printer Setup Information

Printer drivers allow you to save the printer settings you use most often as the default settings. For example, the driver might be set to print on letter size paper, portrait orientation, with automatic tray selection (from the first available tray).

Some PCL 6 printer drivers will allow you to save printer settings for multiple kinds of print jobs. For example, you might want to create a Quick Set for envelopes, or for printing the first page of a document on letterhead.

New Printer Driver Features

Look for **Quick Sets**, **Scale to Fit** (any page size to any page size), and **Booklet Printing** options in the Windows PCL 6 printer driver, or see the printer driver help for more information.

Continued on next page.



Printing with a Watermark

A watermark is a notice, such as “Top Secret,” printed in the background of each page in a document. Check the driver for available options.



Different First Page

- 1 Select “Use different paper for first page” in your printer driver. Choose Tray 1 (or Manual Feed) for the first page and one of the other trays for the remaining pages. Place the paper for the first page in Tray 1. (For manual feed, place paper in Tray 1 after the job is sent to the printer, and the printer requests paper.) Place the paper with the side-to-be-printed up, the top of the page facing the rear of the printer, and the long edge leading into the printer.

Note

Where and how you make selections depends on your software application or associated printer driver. (Some options may only be available through the printer driver.)

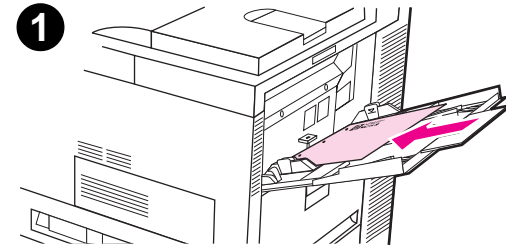

- 2 Load the paper for the remaining pages of the document into another tray. You may select the first and remaining pages by type of paper. For more information, see [“Printing by Type and Size of Paper”](#) on page 134.

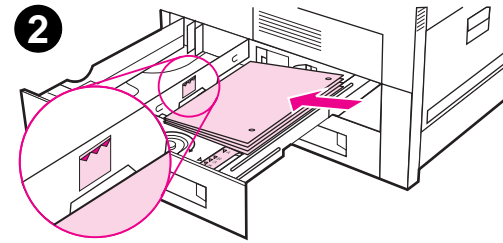

Printing Multiple Pages on One Sheet of Paper

You can print more than one page on a single sheet of paper. This feature is available in some printer drivers, and provides a cost-effective way to print draft pages.

To print more than one page on a sheet of paper, look for a Layout or Pages Per Sheet option in the printer driver. (This is sometimes called 2-up, 4-up, or n-up printing.)

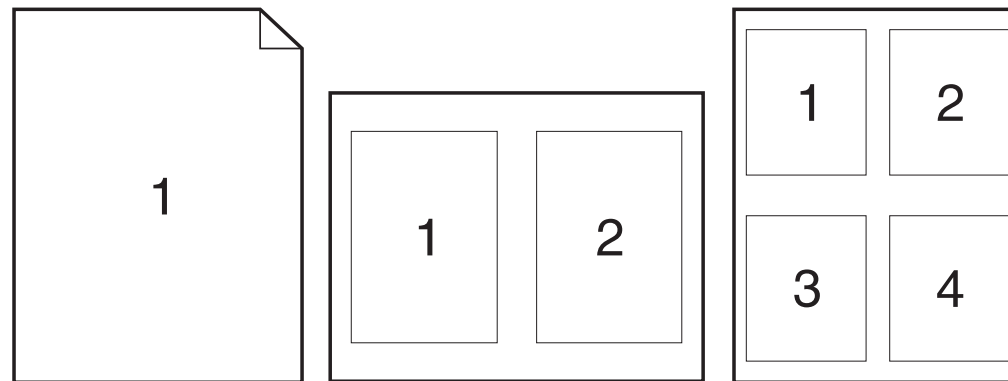

Customizing Tray 1 Operation

Customize Tray 1 to fit your printing needs.

The printer can be set to print from Tray 1 as long as it is loaded, or to print only from Tray 1 if the type of paper loaded is specifically requested. Set `TRAY 1 MODE=FIRST` or `TRAY 1 MODE=CASSETTE` from the Paper Handling Menu in the printer's control panel. (Print speed might be slightly slower when printing from Tray 1 when `TRAY 1 MODE=FIRST`.)

Tray 1 Mode=First

If you do not keep paper in Tray 1 all the time, or you use Tray 1 only for manually feeding paper, keep the default setting, `TRAY 1 MODE=FIRST` in the Paper Handling Menu.

- `TRAY 1 MODE=FIRST` means that the printer usually pulls paper from Tray 1 first unless it is empty or closed.
- You can still choose paper from other trays by specifically choosing another tray in the printer driver or from your software application.



Tray 1 Mode=Cassette

TRAY 1 MODE=CASSETTE means the printer treats Tray 1 like the internal trays. Instead of looking for paper in Tray 1 first, the printer pulls paper either starting from the bottom tray upward (from the tray with the highest capacity to the tray with the least capacity), or the tray that matches type or size settings selected from the software.

- When TRAY 1 MODE=CASSETTE is set, an option appears in the Paper Handling Menu to configure **size** as well as **type** settings for Tray 1.
- Through the printer driver or from within your software application, you can select paper from any tray (including Tray 1) by type, size, or source. To print by type and size of paper, see page [134](#).



Manually Feeding Paper from Tray 1

The Manual Feed feature allows you to print on special paper from Tray 1, such as envelopes or letterhead. If Manual Feed is selected, the printer will print only from Tray 1.

Select Manual Feed through the software or printer driver. Manual Feed can also be enabled from the Paper Handling Menu in the printer's control panel.

Note

When Manual Feed is selected, if TRAY 1 MODE=FIRST the printer automatically prints (if paper is in the tray). If TRAY 1 MODE=CASSETTE the printer prompts to load Tray 1 whether or not Tray 1 is loaded. This enables you to load different paper if necessary. Press **Go** to print from Tray 1.



Printing by Type and Size of Paper

You can configure the printer to select paper by **type** (such as plain or letterhead) and **size** (such as letter or A4), as opposed to **source** (a paper tray).



Benefits of Printing by Type and Size of Paper

If you frequently use several different kinds of paper, once trays are set up correctly, you do not have to check which paper is loaded in each tray before you print. This is especially helpful when the printer is shared, and more than one person loads or removes paper.

Printing by type and size of paper is a way to be sure that print jobs always print on the desired paper. (Some printers have a feature which “locks out” trays, to prevent printing on the wrong paper. Printing by type and size of paper eliminates the need to lock out trays.)



To print by type and size of paper, do the following:

1. Be sure to adjust and load the trays correctly. (See the sections on loading paper, starting on page [76](#).)



Continued on next page.



2. From the Paper Handling Menu in the printer's control panel, select the paper **type** for each tray. If you are unsure what type you are loading (such as bond or recycled), check the label on the package of paper. For supported types, see page [259](#).
3. Select the paper **size** settings from the control panel.
 - **Tray 1:** If the printer has been set to `TRAY 1 MODE=CASSETTE` from the Paper Handling Menu, also set the paper size from the Paper Handling Menu. If custom paper is loaded, set the size of custom paper from the Printing Menu to match the paper loaded in Tray 1. To print custom-size paper, see page [118](#).
 - **Other trays:** Paper size settings are adjusted when paper is properly loaded into the printer. (See the sections on loading paper, starting on page [76](#).)
4. From the software or printer driver, select the desired type and size of paper.



Note

The type and size settings can also be configured from HP JetAdmin for networked printers. See the printer software help.

To print by type and size, it might be necessary to unload or close Tray 1, or set `TRAY 1 MODE=CASSETTE` from the Paper Handling Menu in the printer's control panel. For more information, see page [283](#).

Settings in the printer driver and software application override control panel settings. (Software application settings override printer driver settings.)

4 Printer Maintenance



Overview



This chapter explains basic printer maintenance.

- [Managing the Toner Cartridge](#)
- [Cleaning the Printer](#)



Note

To ensure optimum print quality, the printer will prompt you perform printer maintenance every 350,000 pages. When the PERFORM PRINTER MAINTENANCE message appears on the control panel, you will need to purchase a Printer Maintenance Kit and install the new parts. Then remove the message by turning the service message off in the configuration menu. For ordering information, see page [36](#).

The Printer Maintenance Kit is a consumable and is not covered under warranty.



Managing the Toner Cartridge



HP Policy on Non-HP Toner Cartridges

Hewlett-Packard Company cannot recommend use of non-HP toner cartridges, either new or remanufactured. Because they are not HP products, HP cannot influence their design or control their quality.



To install a new HP toner cartridge and recycle the used cartridge, follow the instructions included in the toner cartridge box.



Toner Cartridge Storage

Do not remove the toner cartridge from its package until you are ready to use it.



CAUTION

To prevent damage to the toner cartridge, do not expose it to light for more than a few minutes.



Toner Cartridge Life Expectancy

The life of the toner cartridge depends on the amount of toner that print jobs require. When printing text at 5% coverage, an HP toner cartridge lasts an average of 15,000 pages. (A typical business letter is about 5% coverage.) This assumes that print density is set to 3 and EconoMode is off. (These are the default settings.)



Continue Printing When Toner is Low

- When toner is low, the printer's control panel displays the TONER LOW message.
- If the TONER LOW message displays, but the printer continues printing, TONER LOW is set to CONTINUE (the default setting).

If the printer stops printing when low toner is detected, TONER LOW is set to STOP. To resume printing, press **Go**.

The printer will continue to display TONER LOW until you replace the toner cartridge.

Select TONER LOW=CONTINUE or TONER LOW=STOP from the Configuration Menu in the control panel (page [295](#)).

Redistributing the Toner

When toner is low, faded or light areas might appear on a printed page. You might be able to temporarily improve print quality by redistributing the toner. The following procedure might allow you to finish the current print job before replacing the toner cartridge.

Continued on next page.



Redistributing the Toner (continued)

- 1 Open the top cover.
- 2 Remove the toner cartridge from the printer.

WARNING!

Avoid reaching too far into the printer. The adjacent fusing area might be hot!

- 3 Rotate the toner cartridge and gently shake it from side to side to redistribute the toner.

Note

If toner gets on your clothing, wipe it off with a dry cloth and wash clothing in cold water. (Hot water sets toner into fabric.)

- 4 Reinsert the toner cartridge into the printer and close the top cover.

If the print remains light, install a new toner cartridge. (Follow the instructions provided with the new toner cartridge.)

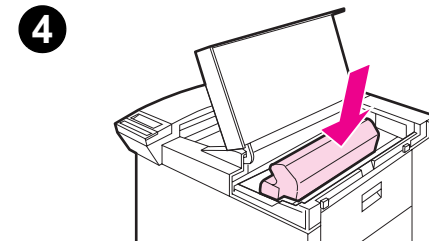
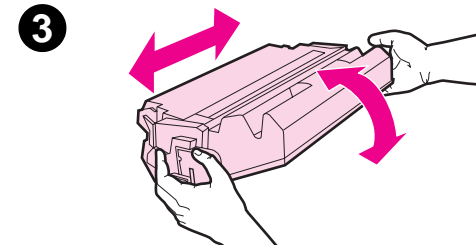
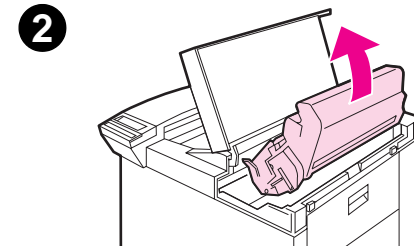
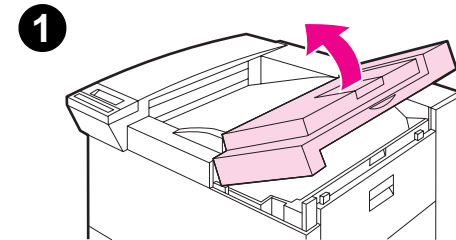

Cleaning the Printer

To maintain print quality, clean the printer thoroughly:

- Every time you change the toner cartridge.
- Whenever print quality problems occur.

Clean the outside of the printer with a lightly water-dampened cloth. Clean the inside with only a dry, lint-free cloth. Observe all warnings and cautions with the cleaning tasks on the following page.

CAUTION To avoid permanent damage to the toner cartridge, do not use ammonia-based cleaners on or around your printer.

Continued on next page.



- 1 Before you begin these steps, turn the printer off and unplug all cables.

WARNING!

Avoid touching the adjacent fusing area in the left door. It may be HOT.

- 2 Open the top cover of the printer and remove the toner cartridge.

CAUTION

Do not touch the transfer roller (A). Skin oils on the roller can reduce print quality. If toner gets on your clothes, wipe it off with a dry cloth and wash your clothes in cold water. Hot water sets toner into fabric.

- 3 With a dry lint-free cloth, wipe any residue from the paper path area, the registration roller (B), and the toner cartridge cavity.
- 4 Replace the toner cartridge, close the printer, reconnect all cables, and turn the printer on.

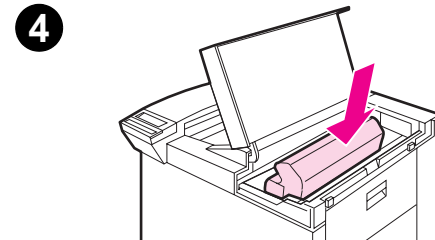
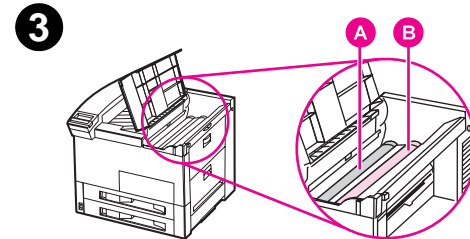
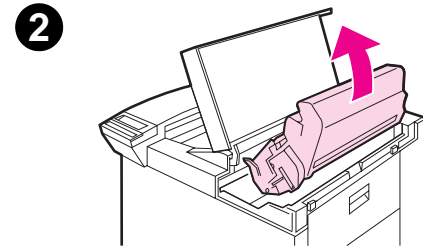
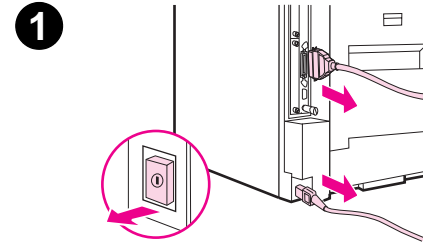

Using the Printer Cleaning Page

If toner specks appear on the front or back side of your print jobs, follow the procedure below.

From the printer's control panel, do the following:

1. Press **MENU** repeatedly until PRINT QUALITY MENU appears.
2. Press **ITEM** repeatedly until CREATE CLEANING PAGE appears.
3. Press **SELECT** to create the cleaning page.
4. Follow the instructions on the cleaning page to complete the cleaning process.

Note In order for the cleaning page to work properly, print the page on copier grade paper (not bond or rough paper).

You might need to print a cleaning page more than once. When toner has been cleaned from inside the printer, shiny black spots will appear on the page's black strip. If white spots appear on the black strip, print a cleaning page again.

To ensure good print quality with certain types of paper, use the cleaning page every time the toner cartridge is replaced. If the cleaning page is frequently needed, try a different type of paper.



5 Problem Solving

Overview

This chapter will help you to solve printer problems.



[Clearing Paper Jams](#)
(see page [146](#))

Occasionally, paper can jam during printing. This section will help you to locate paper jams, properly clear them from the printer, and solve repeated paper jams.

[Understanding Printer Messages](#)

Many different messages can appear on the printer's control panel display. Some messages tell the printer's current status, such as `INITIALIZING`. Other messages require an action, such as `CLOSE TOP COVER`. Many of these messages are self-explanatory. However, some messages indicate a problem with the printer, or require further action or description. This section lists these types of messages, and tells what to do if a message persists.



[Correcting Output Quality Problems](#) (see page [186](#)) The printer should produce print jobs of the highest quality. If print jobs do not look sharp and clear, defects such as lines, specks, or smears appear on the page, or paper is wrinkled or curled, use this section to troubleshoot and solve the output quality problem.

[Determining Printer Problems](#) (see page [189](#)) Before you can fix a printer problem, you must understand where the problem is. Use the tables in this section to determine the printer problem, and then follow the corresponding troubleshooting suggestions.

[Checking the Printer's Configuration](#) (see page [227](#)) From the printer, you can print information pages, which give details about the printer and its configuration.



Clearing Paper Jams

If the printer's control panel displays a paper jam message, look for paper in the locations indicated in the [graphic below](#), then see the procedure for clearing the paper jam. You might need to look for paper in other locations than indicated in the paper jam message. If the location of the paper jam is not obvious, look first in the top cover area.

When clearing paper jams, be very careful not to tear the paper. If a small piece of paper is left in the printer, it could cause additional jams. If paper jams are a recurring problem, see page [166](#).

Note After the jam is cleared, the top cover of the printer must be opened and closed to clear the paper jam message from the control panel.

Continued on next page.



Paper jams can occur at the following locations:

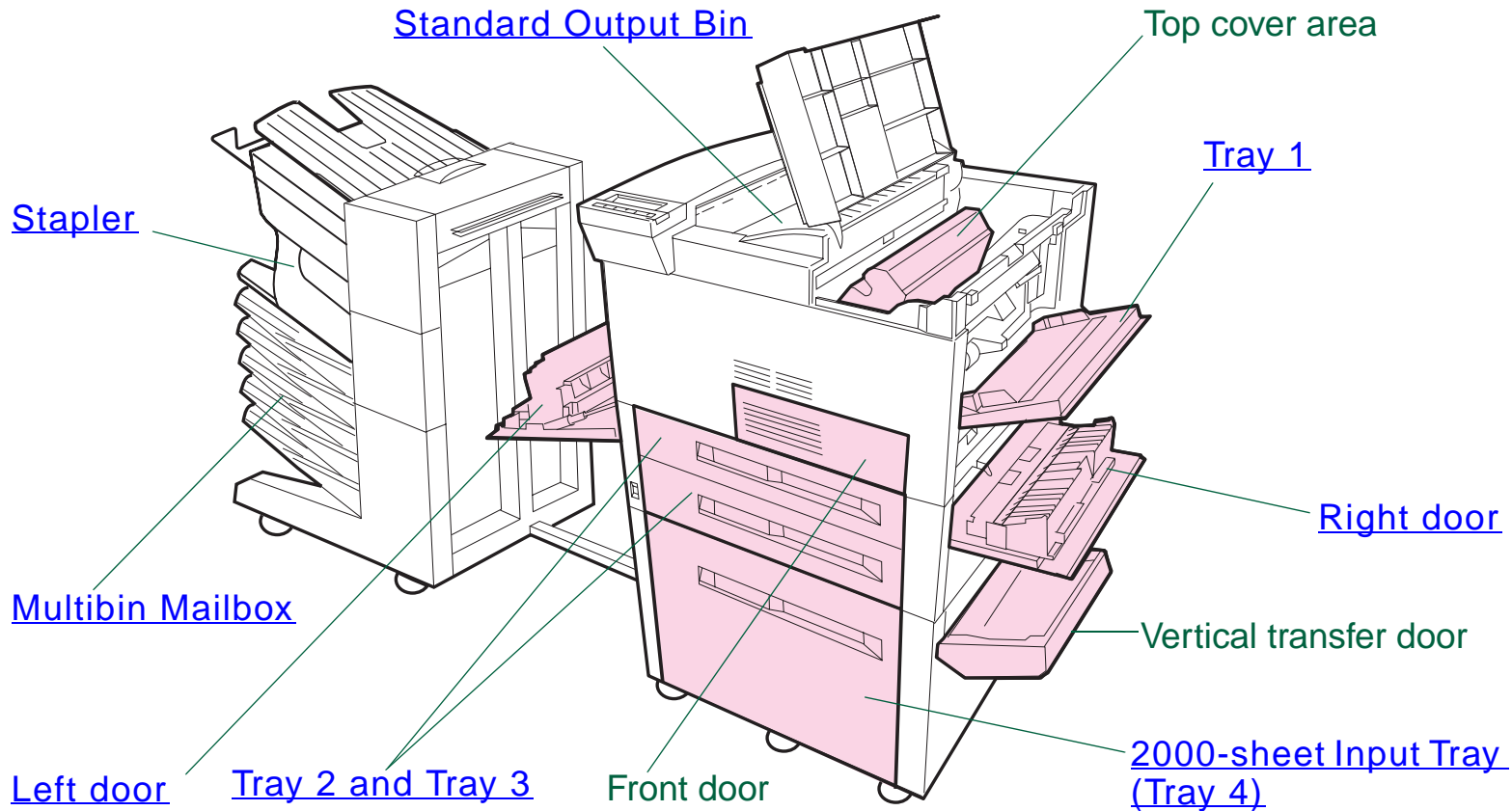

Note

Loose toner might remain in the printer after a paper jam, but the toner should clear after a few sheets are printed.

Clearing Paper Jams

Clearing Jams from the Input Tray Areas

Clearing Tray 1

1. Open Tray 1 by pulling down.
2. Check for paper in the Tray 1 area.
3. Remove any paper from this area by pulling it in the direction shown by the arrow in the graphic below. Carefully check to be sure you have removed all pieces of torn paper.
4. Open and close the top cover.

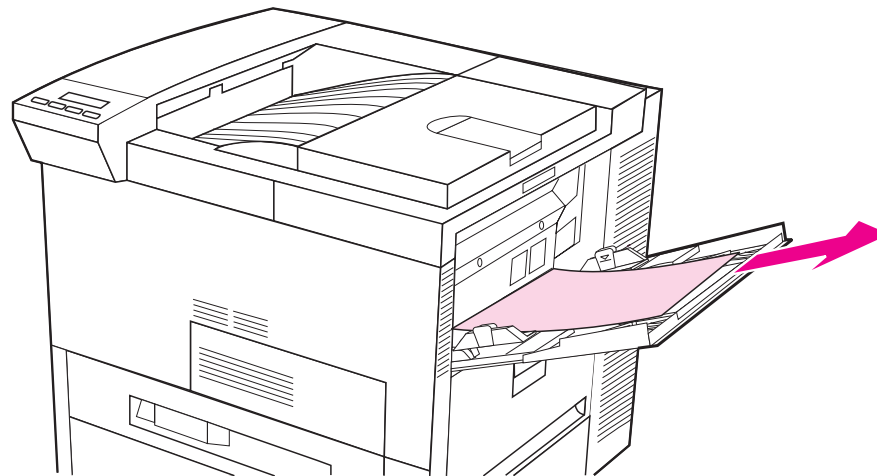

Clearing the Right Door

1. Open the right door located below Tray 1.
2. Check for paper in this area.
3. Open the jam access cover using the green lever.
4. Remove any paper from this area by pulling it out of the printer.
5. Be sure to remove all pieces of torn paper.
6. Open and close the top cover.

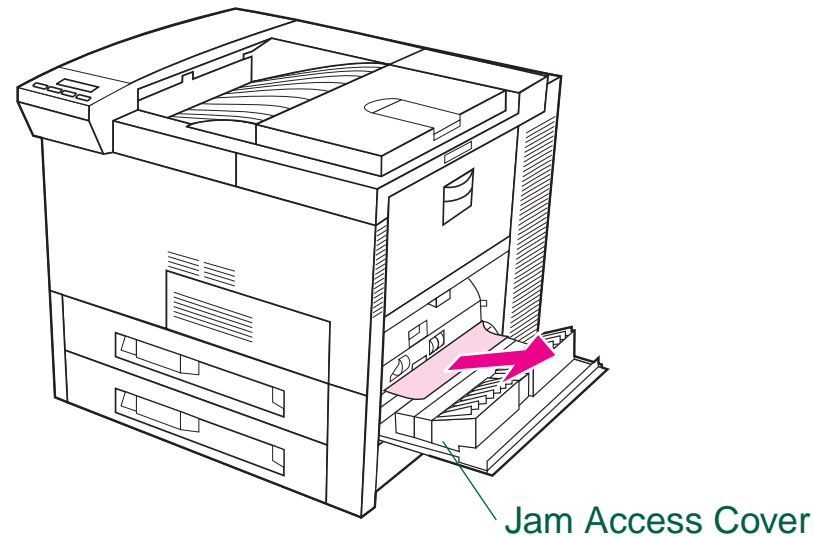

Clearing Trays 2 and 3

1. Open the tray.
2. Remove jammed or damaged paper from this area by pulling it out of the printer.
3. Be sure to remove all pieces of torn paper.
4. Close the tray.
5. Open and close the top cover.

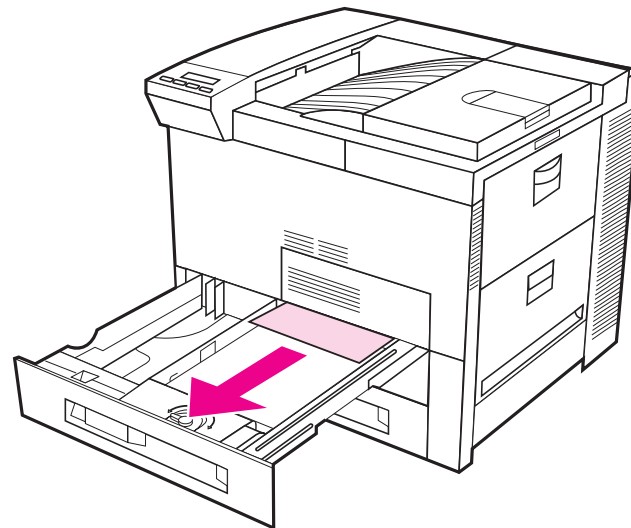

Clearing the Optional 2 x 500-sheet Input Trays (4 and 5)

1. Open the tray.
2. Remove damaged or jammed paper from area (A) by pulling it out of the printer.
3. Be sure to remove all pieces of torn paper.
4. Close the tray.
5. Open the vertical transfer door and remove jammed paper (B).
6. Close the vertical transfer door.
7. Open and close the top cover.

Continued on next page.



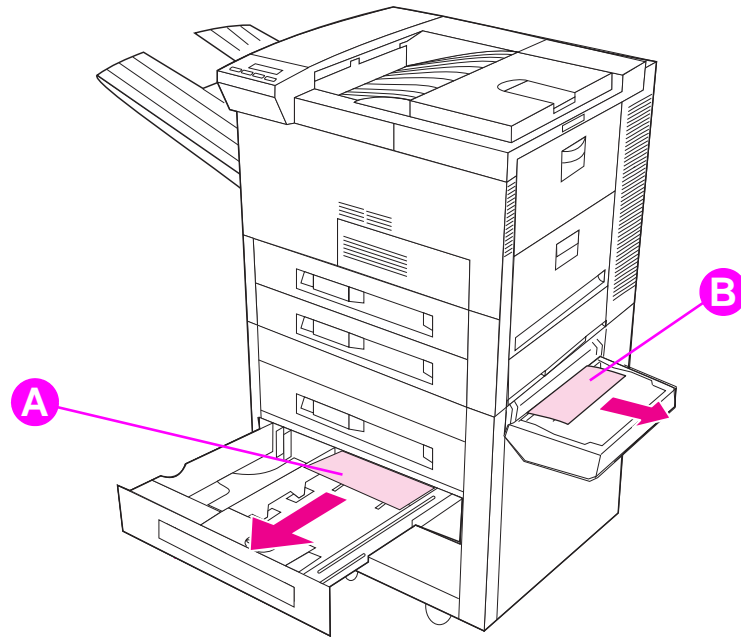

Clearing the Optional 2000-sheet Input Tray (Tray 4)

1. Open Tray 4.
2. Remove damaged or jammed paper from area (A) by pulling it out of the printer.
3. Be sure to remove all pieces of torn paper.
4. Close the tray.
5. Open the vertical transfer door and remove all jammed paper (B).
6. Close the vertical transfer door.
7. Open and close the top cover.

Continued on next page.



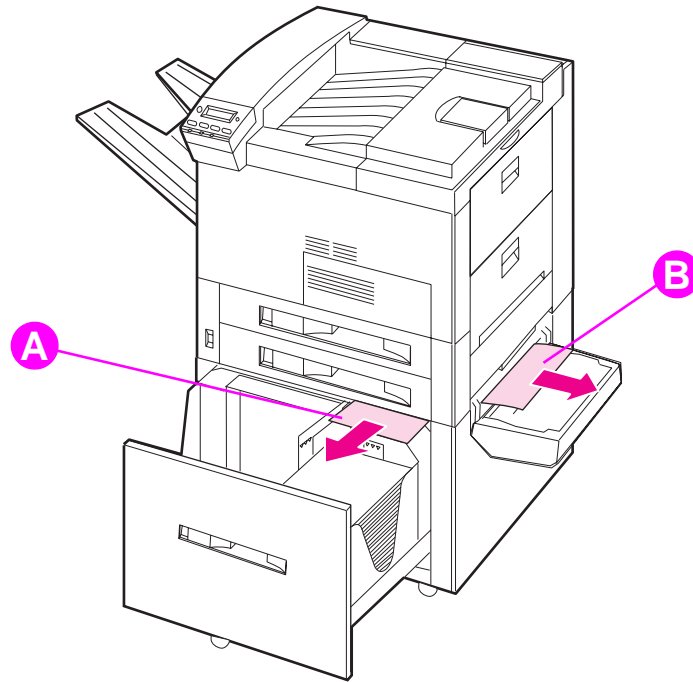

Clearing the Optional Envelope Feeder

1. Open the top cover.
2. Remove toner cartridge.



WARNING! Avoid touching the adjacent fusing area. It may be HOT.

3. Remove envelopes in this area by pulling them straight up and out of the printer.
4. Be sure to remove any pieces of torn paper. Lift both of the green user tabs and remove any envelopes that may be hidden.
5. You may need to remove any loaded envelopes and the optional envelope feeder to release envelopes or torn pieces of paper.
6. Replace the optional envelope feeder and toner cartridge and close the top cover.



Continued on next page.



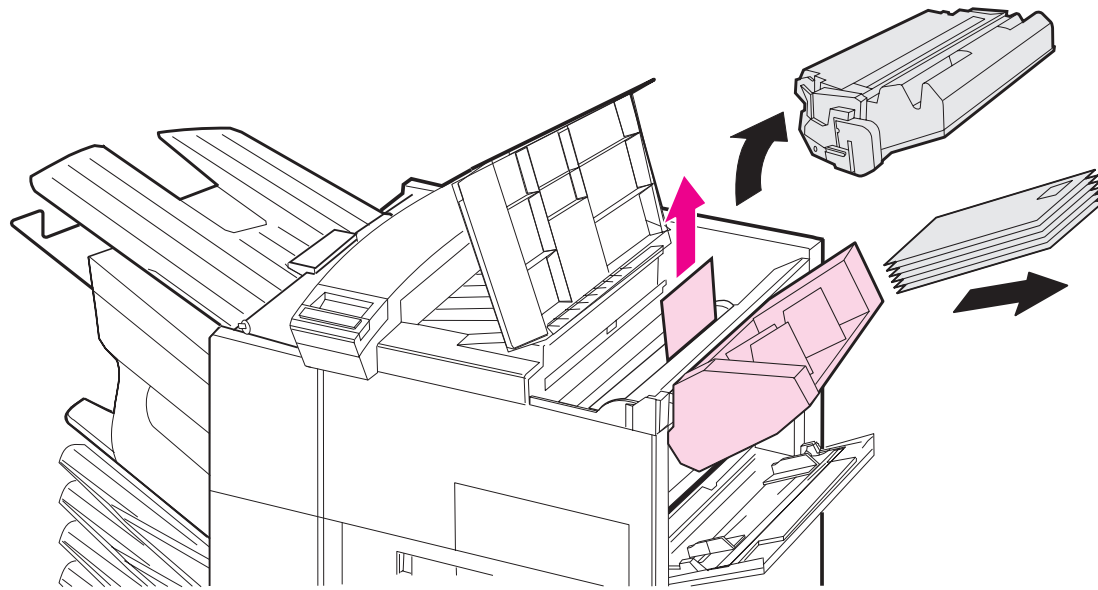

Clearing Jams from the Optional Duplex Printing Accessory

1. Open the front door.
2. Check for paper in this area.
3. Remove any paper from area (A) by pulling it out of the printer. Be careful not to tear the paper.
4. If you cannot remove all the paper through the front door, open the left door and carefully pull out any paper from area (B). (If a mailbox accessory is installed, first push it away from the printer to access the left door.)



WARNING! Avoid touching the adjacent fusing area. It may be HOT.

5. If a duplexer is installed, turn the printer off and remove the duplexer (C) by pressing the colored tab on the lower right side of the unit and pulling the entire unit out of its slot.
6. Remove any paper remaining in the duplexer (C).
7. Reinstall the duplexer by sliding it back into the slot until it clicks into place. Close all open doors. If a mailbox is installed, push it back into place and turn the printer on.



Continued on next page.

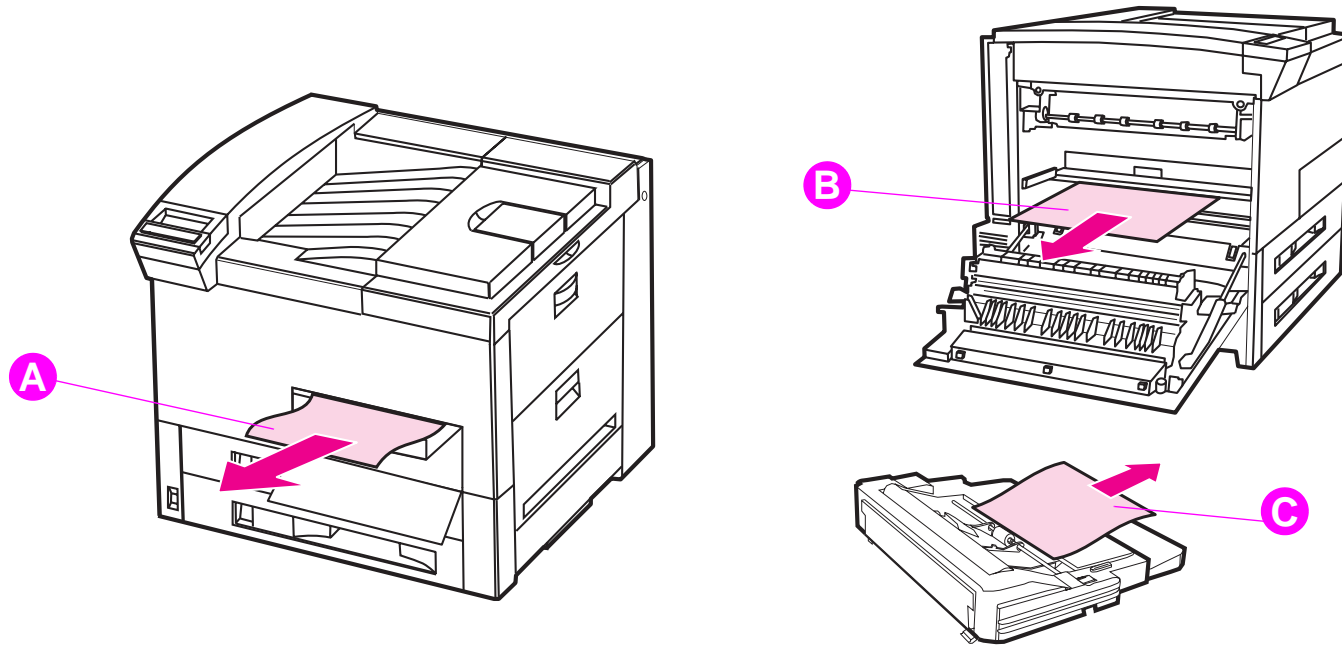

Clearing Jams from the Top Cover Area

1. Open the top cover.
2. Remove the toner cartridge.

WARNING! Avoid touching the adjacent fusing area. It may be HOT.

3. Lift Handle 2 and then lift Plate 3 to remove any paper that may be hidden.
4. Remove any paper in this area by pulling it straight up and out of the printer.
5. Be sure to remove all pieces of torn paper.
6. Replace the toner cartridge and close the top cover.

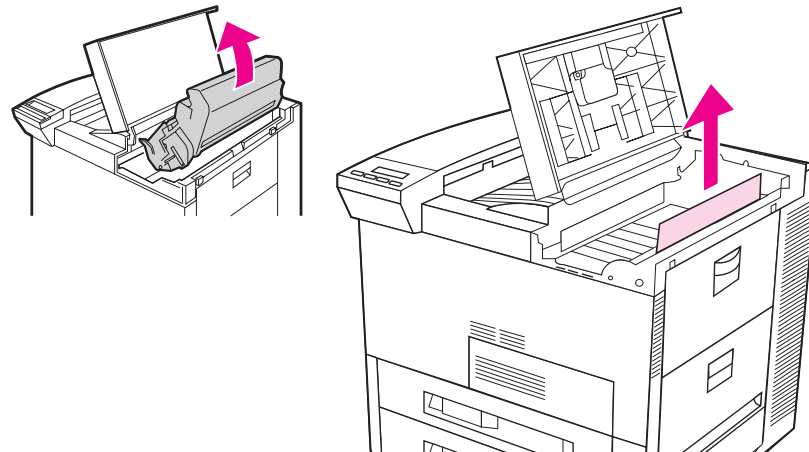

Clearing Jams from the Output Areas

Clearing the Standard Output Bin

If the paper jam extends into the output area, as shown in the graphic below, slowly and carefully pull the paper straight out of the printer so that it does not tear.

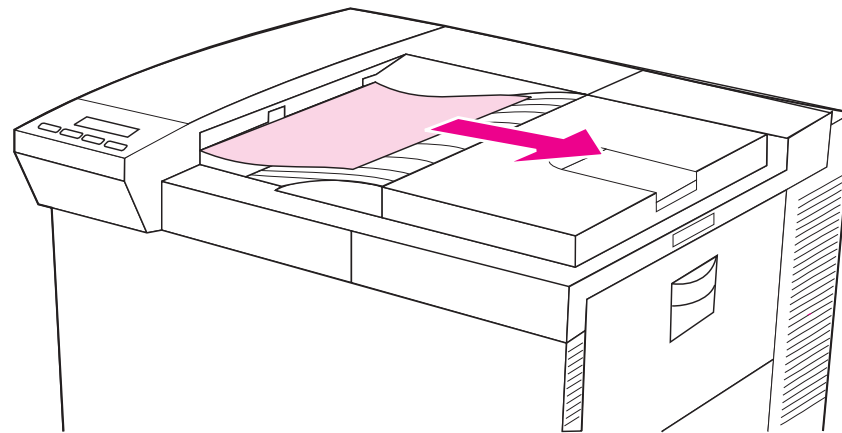

Clearing the Left Door (Fuser Area)

1. Open the left door. (If a mailbox accessory is installed, first push it away from the printer to access the left door.)

WARNING! Avoid touching the adjacent fusing area. It may be HOT.

2. Remove any jammed or damaged paper from this area by pulling it out of the printer (A).
3. Press down on the green tabs (B) and carefully check for paper. Be sure to remove all pieces of torn paper.
4. Close the left door. If a mailbox is installed, push it back into place.

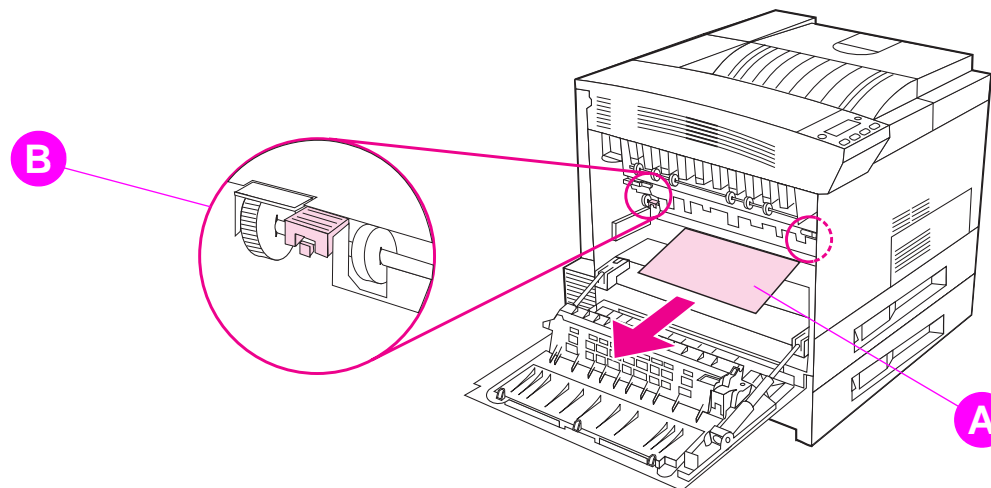

Clearing the Optional Multibin Mailboxes

1. Turn off the printer.
2. Remove the Left Output Bin.
3. Remove paper from area (A) by carefully pulling it out, away from the printer.
4. Pull the mailbox away from the printer and remove any paper in area (B). Be sure to remove any torn pieces of paper.
5. Remove any paper in area (C) by carefully pulling it out of the printer.



Note

When clearing paper jams, be very careful not to tear the paper. If a small piece of paper is left in the printer, it could cause additional jams. If paper jams are a recurring problem, see page [166](#).

Continued on next page.



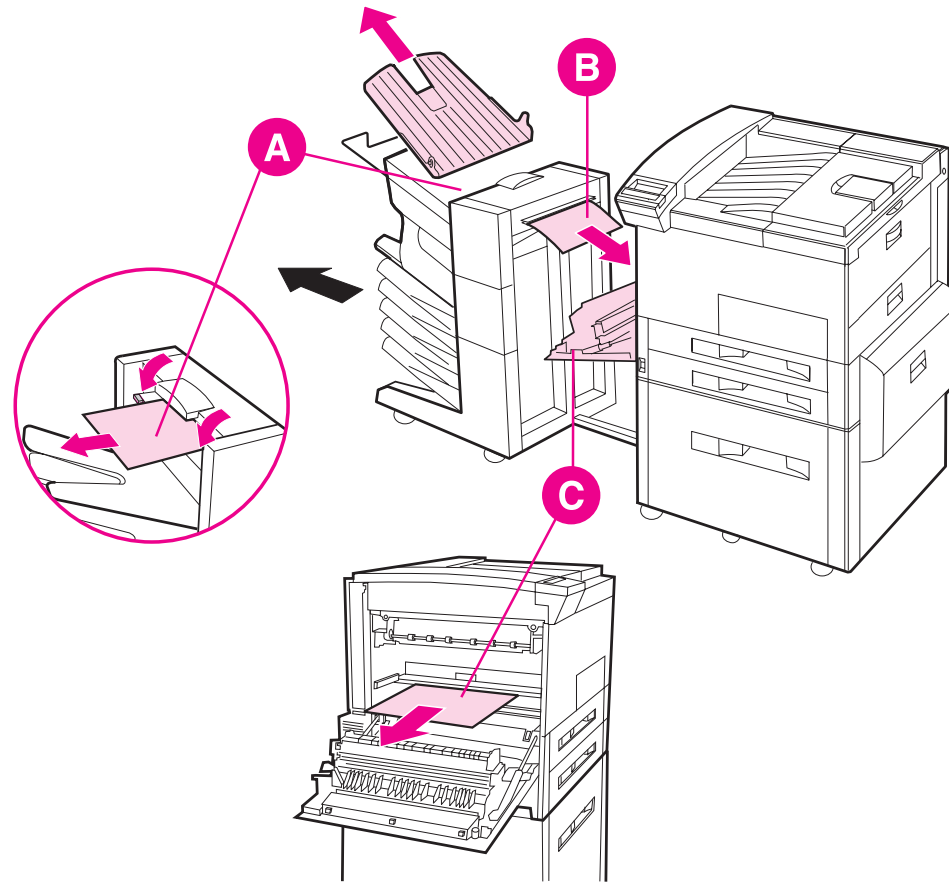

Clearing Jams from the Stapler

- 1 Remove the Left Output Bin.
- 2 Open the stapler unit cover.
- 3 Press the colored tab with your forefinger and pull the colored circular tab with your other forefinger to open the stapler.
- 4 Remove loose or damaged staples from the stapler head. Push the circular tab to snap it back into place.

Continued on next page.

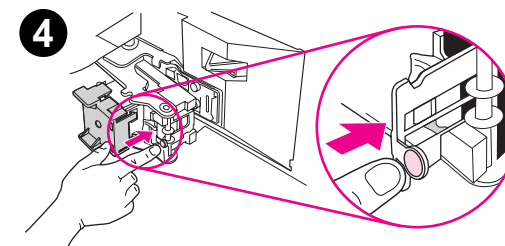
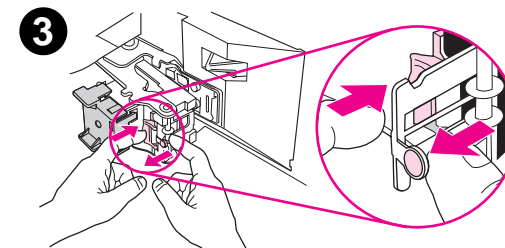
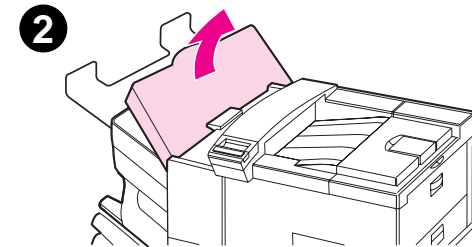
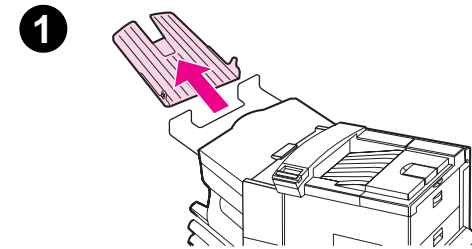

- 5 Close the stapler unit cover and replace the Left Output Bin.
- 6 Clear all paper paths that may have jammed as a result of the jammed staples.

5

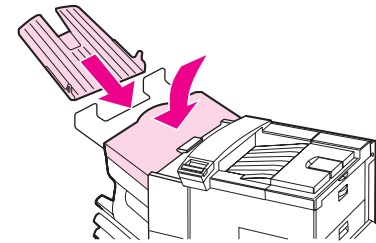

Note

After clearing a stapler jam, up to 12 documents may not be stapled when printing resumes because the stapler must reload. Once the unit begins stapling again, either manually staple the unstapled documents or resend the job.

If a print job is sent and the stapler is jammed or out of staples, the job will still print.



Solving Repeated Paper Jams



Situation	Solution
<p>General repeated paper jam problems</p>	<ol style="list-style-type: none"> 1. Check to see that paper is correctly loaded in the trays, and that all width guides are correctly set (not skewed). See Chapter 2, "Printing Tasks." 2. Ensure that the paper tray is set for the size of paper installed and that the tray is not overloaded with paper. 3. Try turning over the stack of paper in the tray. If you are using letterhead paper, try printing from Tray 1. 4. Do not use previously printed paper or torn, worn, or irregular paper. For recommended paper and other paper for your printer, see page 254. 5. Check the paper specifications. (If paper is outside of the recommended specifications, problems may occur.) 6. When duplexing, the printer rolls paper under Tray 3 and causes a jam. Pull Tray 3 out of the printer completely and remove any paper from under the tray. Insert Tray 3 back into the printer.



Situation	Solution
	<ol style="list-style-type: none"><li data-bbox="679 302 1711 386">7. Printer may be dirty. Clean the printer as described on page 141.<li data-bbox="679 435 1659 477">8. Check that the correct paper size is installed (page 254).<li data-bbox="679 526 1777 610">9. Check that all damaged or jammed paper is removed by pulling it out of the printer.



Note If jams continue, contact your authorized HP service provider.



Understanding Printer Messages

The following table explains messages that might display on the printer's control panel. Printer messages and their meanings are listed in alphabetical order, with numbered messages following.

If a message persists:

- If a message persists requesting that you load a tray, or if a message indicates that a previous print job is still in the printer's memory, press **Go** to print or press **CANCEL JOB** to clear the job from the printer's memory.
- If a message persists after performing all of the recommended actions, contact an HP-authorized service or support provider. (See the [HP Support](#) pages at the front of this user guide.)

Note

Not all messages are described in this user guide (many are self-explanatory).

Some printer messages are affected by the **AUTO CONTINUE** and **CLEARABLE WARNING** settings from the Configuration Menu in the printer's control panel (page [295](#)).

Continued on next page.





Printer Messages

Message	Explanation or Recommended Action
ACCESS DENIED MENUS LOCKED	The printer control panel function you are trying to access has been locked to prevent unauthorized access. See your network administrator.
BAD DUPLEXER CONNECTION	The duplexer is not connected properly. Re-install the duplexer.
CHECK INPUT DEVICE alternates with PAPER PATH OPEN PLEASE CLOSE IT	The optional input tray cannot feed paper to the printer because a door or paper guide is open. Check the doors and paper guides.
CHECKING PAPER PATH	The engine is rolling its rollers to check for possible paper jams.
CHOSEN LANGUAGE NOT AVAILABLE	A print job requested a printer language that does not exist in the printer. The job will not print and will be cleared from memory. Print the job using a driver for a different printer language, or add the requested language to the printer (if available). Press Go to continue.
DISK DEVICE FAILURE	The EIO disk had a critical failure and can no longer be used. Remove the EIO disk and replace it with a new one.



Understanding Printer Messages

Printer Messages (continued)

Message	Explanation or Recommended Action
DISK FILE OPERATION FAILED	The requested operation could not be performed. You might have attempted an illegal operation, such as trying to download a file to a non-existent directory.
DISK FILE SYSTEM IS FULL	Delete files from the EIO disk and then try again. Download or delete files from HP JetAdmin, and download or delete fonts from HP FontSmart. (See the software help for more information.)
DISK IS WRITE PROTECTED	The EIO disk is protected, and no new files can be written to it. Disable the write protection through HP JetAdmin.
EIO n DISK INITIALIZING	The disk accessory card takes a long time to initialize. The first parameter is the accessory slot number for this disk accessory card.
EIO n DISK NOT FUNCTIONAL	The EIO disk is not working correctly.



Printer Messages (continued)

Message	Explanation or Recommended Action
EIO n INITIALIZING alternates with DO NOT POWER OFF	<p>Wait for the message to disappear (approximately 5 minutes). If the printer EIO card is operating correctly and communicating with the network, this message disappears after approximately one minute and no action is required.</p> <p>If the EIO card is unable to communicate with the network, this message remains for five minutes and then disappears. In this case the printer is not communicating with the network (even though the message is no longer present). The problem may be a bad EIO card, a bad cable or connection on the network, or a network problem. Contact your network administrator.</p>
EIO n DISK SPINNING UP	The disk accessory card takes a long time to initialize. The first parameter is the accessory slot number for this accessory card.
ENV FEEDER LOAD [TYPE] [SIZE]	<p>Load the requested envelope type and size into the envelope feeder. Make sure the envelope size and type are set correctly from the Paper Handling Menu in the printer's control panel (page 283).</p> <p>Press GO if the desired envelope is already loaded in the feeder. Press -VALUE+ to scroll through the available types and sizes. Press SELECT to accept the alternate type or size.</p>
EXTERNAL DEVICE INITIALIZING	When an external paper handling device is connected to the printer, it must have 10 seconds to initialize after boot or after coming out of Power Save mode.



Printer Messages (continued)

Message	Explanation or Recommended Action
FINISHER LOW ON FINISHING AGENT	The finishing device is running out of its finishing material and needs to be refilled.
FLASH DEVICE FAILURE	The flash DIMM had a critical failure and no longer can be used. Remove the flash DIMM and replace it with a new one.
FLASH FILE OPERATION FAILED	The requested operation could not be performed. You might have attempted an illegal operation, such as trying to download a file to a non-existent directory.
FLASH FILE SYSTEM IS FULL	Delete files from the flash DIMM. Download or delete files from HP JetAdmin, and download or delete fonts from HP FontSmart. (See the software help for more information.)
FLASH IS WRITE PROTECTED	The flash DIMM is protected, and no new files can be written to it. Disable the write protection through HP JetAdmin.
INPUT DEVICE CONDITION xx.yy	An input paper handling device has a condition that needs attention before printing can resume. See the documentation that came with the paper handling device for assistance.
LOADING PROGRAM <number> alternates with DO NOT POWER OFF	Programs and fonts can be stored on the printer's file system. At bootup time these entities are loaded into RAM. (These entities can take a long time to load into RAM depending on the size and number of entities being loaded.) The <number> specifies a sequence number indicating the current program being loaded.

**Understanding Printer Messages**

Printer Messages (continued)

Message	Explanation or Recommended Action
MANUALLY FEED [TYPE] [SIZE]	Load the requested paper into Tray 1. Press Go if the desired paper is already loaded in Tray 1. Press -VALUE + to scroll through the available types and sizes. Press SELECT to accept the alternate type or size.
MEMORY FULL STORED DATA LOST	There is no available memory in the printer. The current job might not print correctly and some resources (such as downloaded fonts or macros) might have been deleted. You might want to add more memory to the printer (page 310).
MEMORY SETTINGS CHANGED	The printer changed its memory settings because it did not have enough memory to use the previous settings for I/O Buffering and Resource Saving. This usually occurs after removing memory from the printer, adding a duplexer, or adding a printer language. You might want to change memory settings for I/O Buffering and Resource Saving (although default settings are usually best) or add more memory to the printer (page 310).
MEMORY SHORTAGE JOB CLEARED	The printer did not have enough free memory to print the entire job. The remainder of the job will not print and will be cleared from memory. Press Go to continue. Change the Resource Saving setting from the printer's control panel (page 279) or add more memory to the printer (page 310).

**Understanding Printer Messages**

Printer Messages (continued)

Message	Explanation or Recommended Action
MEMORY SHORTAGE PAGE SIMPLIFIED	The printer had to compress the job in order to fit it in available memory. Some data loss might have occurred. Press Go to continue. You might want to add more memory to the printer (page 310).
OFFLINE	Press Go to place the printer online.
OUTPUT BIN FULL CLEAR (BIN nnn) n (bin name)	The output bin is full and needs to be emptied.
PERFORM PRINTER MAINTENANCE	To ensure optimum print quality, the printer prompts you to perform routine maintenance every 350,000 pages. To order a Printer Maintenance Kit, see page 36 .
RAM DISK DEVICE FAILURE	The RAM disk had a critical failure and can no longer be used. Turn the printer off, and then turn the printer on to clear the message.
RAM DISK FILE OPERATION FAILED	The requested operation could not be performed. You might have attempted an illegal operation, such as trying to download a file to a non-existent directory.



Understanding Printer Messages

Printer Messages (continued)

Message	Explanation or Recommended Action
RAM DISK FILE SYSTEM IS FULL	Delete files and then try again, or turn the printer off, and then turn the printer on to delete all files on the device. (Delete files using HP JetAdmin, HP FontSmart, or another software utility. See the software help for more information.) If the message persists, increase the size of the RAM disk. Change the RAM disk size from the Configuration Menu in the printer's control panel (page 295).
STAPLER LOW ON STAPLES	The stapler device is running out of staples and needs to be refilled.
TONER LOW	See page 139 .
TRAY × EMPTY	Load the empty tray (×) to clear the message. If you do not load the specified tray, the printer will continue printing from the next available tray, and the message will continue to display.



Printer Messages (continued)

Message	Explanation or Recommended Action
TRAY x LOAD [CTYPE] [SIZE]	<p>Load the requested paper into the specified tray (x). (See the sections on loading paper, starting on page 76.)</p> <p>Ensure that the trays are correctly adjusted for size. The tray type settings (and size for Tray 1) must be set from the printer's control panel (page 134).</p> <p>If you are trying to print A4 or letter size paper, and this message appears, make sure the default paper size is set correctly from the Printing Menu in the printer's control panel.</p> <p>Press GO to print from the next available tray.</p> <p>Press -VALUE + to scroll through the available types and sizes. Press SELECT to accept the alternate type or size.</p>
TRAY 2 LOAD LEGAL (or similar messages requesting that you load paper)	<p>Load the requested paper into the indicated tray, or press SELECT to override the message and to print on a loaded paper size.</p>
UNABLE TO MOPY JOB	<p>Memory or file system failures would not allow a mopy job to occur. Only one copy will be produced.</p>
UNSUPPORTED SIZE IN TRAY [YY]	<p>An external paper handling device detected an unsupported paper size. The printer will go offline until the condition is corrected.</p>



Understanding Printer Messages

Printer Messages (continued)

Message	Explanation or Recommended Action
USE [TYPE] [SIZE] INSTEAD?	If the requested paper size or type is not available, the printer asks if it should use another paper size or type instead. Press - VALUE + to scroll through the available types and sizes. Press SELECT to accept the alternate type or size.
WAIT FOR PRINTER TO REINITIALIZE	The RAM disk setting has been changed from the printer's control panel. This change will not take effect until the printer reinitializes. If you change the mode of the external device, turn the printer off and then turn the printer on and wait for the printer to reinitialize.
WRONG ENVELOPE FEEDER INSTALLED	The envelope feeder you are trying to install will not work for this printer. To order an envelope feeder for the printer, see page 36 . Make sure the is installed correctly (page 109).
XX.YY PRINTER ERROR PRESS GO TO CONTINUE	A printer error has occurred which can be cleared by pressing GO in the printer's control panel.
13.x PAPER JAM [LOCATION]	Remove jammed paper from the specified location (page 146). Open and close the top cover to clear the message. If the message persists after all jams have been cleared, a sensor might be stuck or broken. Contact an HP-authorized service or support provider. (See the HP Support pages at the front of this user guide.)

**Understanding Printer Messages**

Printer Messages (continued)

Message	Explanation or Recommended Action
20 INSUFFICIENT MEMORY alternates with PRESS GO TO CONTINUE	The printer received more data than can fit in its available memory. You might have tried to transfer too many macros, soft fonts, or complex graphics. Press Go to print the transferred data (some data might be lost), then simplify the print job or install additional memory (page 310).
21 PAGE TOO COMPLEX alternates with PRESS GO TO CONTINUE	The data (dense text, rules, raster or vector graphics) sent to the printer was too complex. Press Go to print the transferred data. (Some data might be lost.) To print the job without losing data, from the Configuration Menu in the printer control panel, set PAGE PROTECT=ON, print the job, and then return PAGE PROTECT=AUTO. (See page 295 .) Do not leave PAGE PROTECT=ON; it might degrade performance. If this message appears often, simplify the print job.
22 EIO ✕ BUFFER OVERFLOW alternates with PRESS GO TO CONTINUE	Too much data was sent to the EIO card in the specified slot (✕). An improper communications protocol may be in use. Press Go to clear the message. (Data will be lost.) Check the host configuration. If this message persists, contact an HP-authorized service or support provider. (See the HP Support pages at the front of this user's guide.)



Printer Messages (continued)

Message	Explanation or Recommended Action
22 PARALLEL I/O BUFFER OVERFLOW alternates with PRESS GO TO CONTINUE	<p>Too much data was sent to the parallel port. Check for a loose cable connection and be sure to use a high-quality cable (page 41). (Some non-HP parallel cables might be missing pin connections, or might otherwise not conform to the IEEE-1284 specification.)</p> <p>This error can occur if the driver you are using is not IEEE-1284 compliant. For best results, use an HP driver that came with the printer (page 55).</p> <p>Press Go to clear the error message. (Data will be lost.)</p> <p>If this message persists, contact an HP-authorized service or support provider. (See the HP Support pages at the front of this user guide.)</p>
40 EIO x BAD TRANSMISSION alternates with PRESS GO TO CONTINUE	<p>The connection has been broken between the printer and the EIO card in the specified slot.</p> <p>Press Go to clear the error message and continue printing.</p>



Printer Messages (continued)

Message	Explanation or Recommended Action
41.3 UNEXPECTED PAPER SIZE	<p>The paper size you are trying to print is not the same as the control panel setting for Tray 1.</p> <p>Make sure that control panel setting for Tray 1 or the Envelope Feeder is correctly adjusted for size. (The printer will continue trying to print the job until size settings are correct.)</p> <p>After performing the actions above, press Go. The page containing the error will automatically be reprinted. (Or, you might want to press CANCEL JOB to clear the job from the printer's memory.)</p>
41.x PRINTER ERROR alternates with PRESS GO TO CONTINUE	<p>A temporary printing error occurred.</p> <p>Press Go. The page containing the error will automatically be reprinted.</p> <p>If this message persists, contact an HP-authorized service or support provider. (See the HP Support pages at the front of this user guide.)</p>
50.x FUSER ERROR	<p>An internal error has occurred. Turn the printer off, and then turn the printer on.</p> <p>The message might clear, and then reappear when the next print job is sent. If this message persists, contact an HP-authorized service or support provider. (See the HP Support pages at the front of this user guide.)</p>



Printer Messages (continued)

Message	Explanation or Recommended Action
51.x or 52.x PRINTER ERROR	A temporary printing error occurred. Press Go . The page containing the error will automatically be reprinted. If this message persists, contact an HP-authorized service or support provider. (See the HP Support pages at the front of this user guide.)



Printer Messages (continued)

Message	Explanation or Recommended Action
53. x _y .zz PRINTER ERROR	<p>There is a problem with the printer's memory. The DIMM that caused the error will not be used. Values of x, y, and zz are as follows:</p> <p>x = DIMM type 0 = ROM 1 = RAM</p> <p>y = Device location 0 = Internal memory (ROM or RAM) 1 to 3 = DIMM slots 1, 2, or 3</p> <p>zz = Error number</p> <p>You might need to replace the specified DIMM. Turn the printer off, and then replace the DIMM that caused the error. If this message persists, contact an HP-authorized service or support provider. (See the HP Support pages at the front of this user guide.)</p>



Printer Messages (continued)

Message	Explanation or Recommended Action
55.x _x PRINTER ERROR alternates with PRESS GO TO CONTINUE	A temporary printing error occurred. Press Go . The page containing the error will automatically be reprinted. If this message persists, contact an HP-authorized service or support provider. (See the HP Support pages at the front of this user guide.)
62.x PRINTER ERROR	There is a problem with the printer's memory. The x value refers to the location of the problem: 0 = Internal memory 1 to 3 = DIMM slots 1, 2, or 3 You might need to replace the specified DIMM. If this message persists, contact an HP-authorized service or support provider. (See the HP Support pages at the front of this user guide.)
64.x PRINTER ERROR	A temporary printing error occurred. Turn the printer off, and then turn the printer on. If this message persists, contact an HP-authorized service or support provider. (See the HP Support pages at the front of this user guide.)



Printer Messages (continued)

Message	Explanation or Recommended Action
66.xx.zz INPUT DEVICE FAILURE alternates with CHECK CABLES AND CYCLE POWER	An error occurred in an external paper handling device. Turn the printer off, and then turn the printer on. If this message persists, contact an HP-authorized service or support provider. (See the HP Support pages at the front of this user guide.)
68 NVRAM ERROR CHECK SETTINGS	An error occurred in the printer's nonvolatile memory (NVRAM) and one or more printer settings has been reset to its factory default. Print a configuration page and check the printer settings to determine which values have changed (page 228). Hold down CANCEL JOB while turning the printer on. This will clean up the NVRAM by removing old areas that are not being used. If this message persists, contact an HP-authorized service or support provider. (See the HP Support pages at the front of this user guide.)
68 NVRAM FULL CHECK SETTINGS	The printer's nonvolatile memory (NVRAM) is full. Some settings might have been reset to the factory defaults. Print a configuration page and check the printer settings to determine which values have changed (page 228). If this message persists, contact an HP-authorized service or support provider. (See the HP Support pages at the front of this user guide.)



Printer Messages (continued)

Message	Explanation or Recommended Action
69.x PRINTER ERROR	A temporary printing error occurred. Turn the printer off, and then turn the printer on. If this message persists, contact an HP-authorized service or support provider. (See the HP Support pages at the front of this user guide.)
79.xxxxx PRINTER ERROR	The printer detected an error. The numbers (xxxxx) indicate the specific type of error. Turn the printer off, and then turn the printer on. Try printing a job from a different software application. If the job prints, go back to the first application and try printing a different file. (If the message only appears with a certain software application or print job, contact the software vendor for assistance.) If the message persists with different software applications and print jobs, record the numbers that appear (xxxxx) and contact an HP-authorized service or support provider. (See the HP Support pages at the front of this user guide.)



Correcting Output Quality Problems

Use the examples below to determine which output quality problem you are experiencing, then see the following tables to troubleshoot the problem.

Note The examples below depict letter-size paper that has passed through the printer long-edge first. (If the paper has passed through the printer short-edge first, lines and repeating defects will run vertically rather than horizontally.)

Continued on next page.



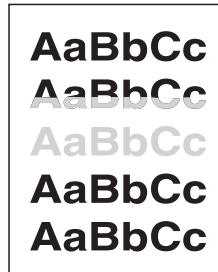

Light Print or Fade

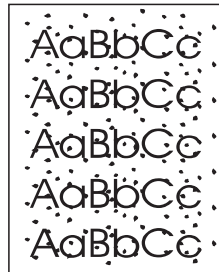

Toner Specks (front or back)

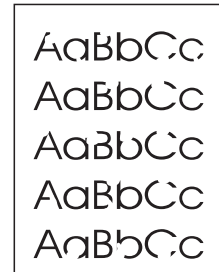

Dropouts

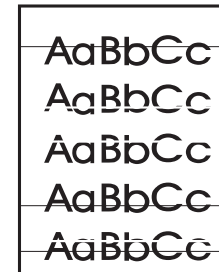

Lines



Gray Background

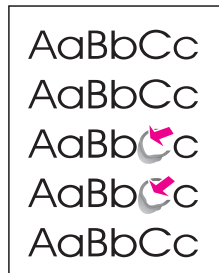

Toner Smear

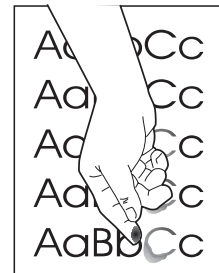

Loose Toner

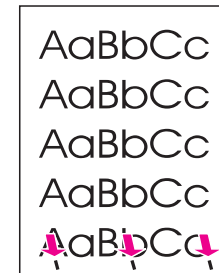

Repeating Defects

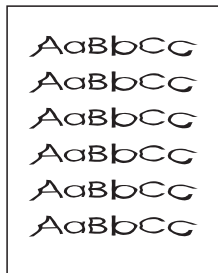

Misformed Characters

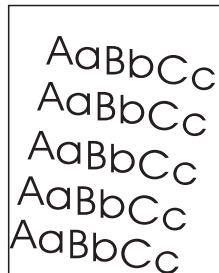

Page Skew

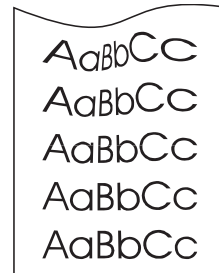

Curl or Wave

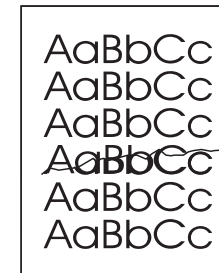

Wrinkles or Creases



Troubleshooting Checklist

- [Printer Does Not Turn On](#)
- [Blank or Garbled Control Panel Display](#)
- [Printer Cannot Print Configuration Page](#)
- [Print Job Does Not Print](#)
- [Computer, Network, or I/O Port Problems](#)
- [Print Speed is Too Slow](#)
- [Printing is Incomplete or Incorrect](#)
- [Printer Ignores Font, Format, or Tray/Bin Selection](#)
- [Problems with Tray 1](#)
- [Problems with Trays 2, 3, and the Optional 2 x 500-sheet Input Tray \(Trays 4 and 5\)](#)
- [Problems with the Optional 2000-sheet Input Tray \(Tray 4\)](#)
- [Problems with the Optional 5-bin Mailbox with Stapler](#)
- [Problems with the Optional Multibin Mailbox \(8 bins\)](#)
- [Problems with the Optional 7-bin Tabletop Mailbox](#)
- [Problems with the Optional Duplex Printing Accessory](#)
- [Problems with the Optional Envelope Feeder](#)
- [Printer Hard Disk](#)
- [PS Troubleshooting](#)



Determining Printer Problems



Printer Does Not Turn On

Check to see if...	Solution
Printer is not plugged in.	Plug the AC power cord firmly into the grounded power receptacle and into the printer. (Be sure the power source is energized.)
Printer voltage is not correct.	Make sure line voltage is in the correct range. (See the product label next to the power receptacle on the back of the printer for voltage requirements.)



Blank or Garbled Control Panel Display

Check to see if...	Solution
Printer is not turned on.	Put the printer's power switch in the on position.
Printer is turned on but internal fans are not running.	Make sure the line voltage is correct for the printer's power configuration. (See the plate next to the power receptacle on the back of your printer for voltage requirements.) If you are using a power strip and its voltage is not within specification, plug the printer directly into the power receptacle.
Display is blank and internal fans are not running.	Press all the keys to see if one is stuck; contact your HP service representative if this does not work.



Blank or Garbled Control Panel Display (continued)

Printer display is in the wrong language or displays unfamiliar characters.	Reconfigure the control panel display language. See the getting started guide.
---	--

**Printer Cannot Print Configuration Page**

Check to see if...	Solution
Correct size of paper is not loaded.	Check paper trays to be sure the correct sizes are loaded (Letter or A4). Also, check that guides are set correctly.
Toner cartridge sealing tape is not removed.	Remove sealing tape from toner cartridge. See the printer's getting started guide or the installation guide that came with the toner cartridge.
Paper tray is out of paper.	Load paper, starting on page 76 .
A printer cover is open.	Firmly close the printer top cover and all doors (left, front, and right).
Paper is jammed in the printer.	Check for paper jams, starting on page 146 .
Messages appear in the display.	See " Understanding Printer Messages " starting on page 168 .



Software, Computer, and Printer Interface Problems

Print Job Does Not Print

Check to see if...	Solution
Printer is off or not connected to an active power source.	Make sure the printer is on and that all power cables are firmly plugged into both the printer components and an active power source.
Printer is offline.	Press GO to put the printer online. Printer should display READY and ON LINE should be lit.
Port is configured and and working properly.	<ul style="list-style-type: none"> ● Connect another printer to current port and print. ● Make sure the print job is being sent to the correct port (LPT1, or network printer port, for example).
Printer is online but not receiving data (the Data light does not blink).	<ul style="list-style-type: none"> ● Check your I/O cable: ● Check for loose I/O cable connections at the printer and computer or network port. ● Try your I/O cable on a system that you know works. ● Check that the correct interface cable was selected and securely connected to both the printer and the computer. If the cable is not correctly configured, see the getting started guide for configuration information.
Printer displays a message.	See “Understanding Printer Messages” starting on page 168 for printer messages and recommended actions.



Print Job Does Not Print (continued)

<p>Data from a previous print job is still in the printer's buffer.</p>	<ul style="list-style-type: none"> ● Ensure that you are using the correct printer driver. ● Complex print job may still be processing. ● Ensure the printer is online. Make sure control panel reads processing job. ● Open the Top Cover. Pull out the toner cartridge and check for paper. Reseat the toner cartridge. ● Open trays 2 and 3. Ensure that the appropriate paper is inserted. (For more information on paper specifications, see page 256.) Close the trays.
<p>Last page did not print and the Data light is on.</p>	<ul style="list-style-type: none"> ● Ensure that you are using the correct printer driver. ● Complex print job may still be processing. ● Ensure the printer is online. Make sure control panel reads processing job. ● Open the Top Cover. Pull out the toner cartridge and check for paper. Reseat the toner cartridge. ● Open trays 2 and 3. Ensure that the appropriate paper is inserted. (For more information on paper specifications, see page 256.) Close the trays.



Print Job Does Not Print (continued)



<p>Data light is flashing but nothing prints.</p>	<ul style="list-style-type: none"> ● Ensure that you are using the correct printer driver. ● Complex print job may still be processing. ● Ensure the printer is online. Make sure control panel reads processing job. ● Open the Top Cover. Pull out the toner cartridge and check for paper. Reseat the toner cartridge. ● Open trays 2 and 3. Ensure that the appropriate paper is inserted. (For more information on paper specifications, see page 256.) Close the trays.
---	--



Print Speed is Too Slow

<p>Situation</p>	<p>Solution</p>
<p>First page takes much longer to print than following pages.</p>	<ul style="list-style-type: none"> ● Make sure that the printer is warm. ● Set the Power Save feature for a longer time period. (See “Configuration Page” on page 228.) If a page takes longer to print due to complex formatting commands, changing the Power Save setting might not improve print speed. You might want to simplify the page.



Print Speed is Too Slow (continued)

<p>Printer is usually slow to respond.</p>	<ul style="list-style-type: none"> ● Printer speed is highly dependent on how your software application is set up, which printer driver you are using, and how much traffic is on the network. See the getting started guide for configuration information. ● You might need to add more memory (page 312).
--	---

Printing is Incomplete or Incorrect

Situation	Solution
<p>Blank pages print.</p>	<ul style="list-style-type: none"> ● Turn the printer off and then back on. ● Make sure the toner cartridge is installed properly. ● Make sure the toner cartridge sealing tape has been removed. Firmly pull the tab straight out from the cartridge to remove the entire length of tape. Avoid touching any black toner on the tape.



Printing is Incomplete or Incorrect (continued)

<p>Garbled pages print, there are overprints, or only a portion of a page prints.</p>	<ul style="list-style-type: none"> ● Ensure that your software application is configured for the correct printer. ● Replace the printer interface (I/O) cable with a cable you know works to see if the cable is defective. ● Your parallel printer cable might be defective. Use a high-quality cable; see page 36 for an HP cable part number. ● Set the PERSONALITY item in the Configuration Menu to AUTO (page 295). The printer may have been set to PCL and a PS job was sent to the printer, or vice versa. ● Data sent to the printer may be corrupt. Try sending another file to see if it prints.
<p>The job was not duplexed.</p>	<ul style="list-style-type: none"> ● Make sure that you are using the correct paper size (page 254). ● You may need to add more printer memory (page 312).
<p>Data is missing, but there are no printer messages.</p>	<ul style="list-style-type: none"> ● Check your software application to be sure the print file contains no errors. ● Check your cable to ensure that it is securely connected to both the printer and the computer. ● Your parallel printer cable may be defective. Use a high-quality cable; see page 36 for an HP cable part number.



Printing is Incomplete or Incorrect (continued)

<p>Printing stops in the middle of the job.</p>	<ul style="list-style-type: none"> ● Check the control panel display for an error message. ● If you are on a network, make sure the computer is correctly configured and there is not a network problem (see your network administrator). ● Check the line voltage to ensure that it is steady and within printer specifications. (See page 273.) Turn the printer off and then back on. ● Check the time-out setting in your network application. You might need to increase it. ● If you are trying to copy a file to the printer from the DOS prompt, use the copy command <code>COPY [filename] LPTn /B printer port</code>, such as LPT1 (where <i>n</i> is the number). <p>Note: To output the page, you might have to send a form feed command from the computer.</p>
<p>Printer printing more copies than requested.</p>	<p>To avoid printing more copies than requested, the collate function in the <i>application</i> must be deselected.</p>



Printer Ignores Font, Format, or Tray/Bin Selection

Printer prints wrong fonts or formats.	<ul style="list-style-type: none"> ● The font is not present in the printer and must be downloaded from your software application, or the proper font DIMM must be installed. Check your software application to ensure the correct printer driver has been installed and configured. To verify that the font you want is available, print a font list (page 232). ● Your software selected a substitute font for one that is not available in the printer. (See your software application manual for more information on font selection.)
Printer draws paper from the wrong tray.	<ul style="list-style-type: none"> ● Be sure your software application is selecting the correct paper size. ● Ensure that the driver for your software application is correctly installed, configured, and capable of requesting the desired paper size and type. ● The size of paper requested is not loaded in the tray selected. The printer draws paper from the next default tray that contains the correct size. Load the correct paper into the tray and make sure the tray is adjusted correctly. Load the tray with enough paper to complete the print job. ● If you selected the 2000-sheet Input Tray (Tray 4) and did not turn the printer off when installing it, the printer does not recognize it and draws paper from the next default tray source. (Turn the printer off, then back on, and the printer will recognize Tray 4.)



Printer Ignores Font, Format, or Tray/Bin Selection (continued)

<p>Control panel settings, such as RESOLUTION or ORIENTATION, do not work or are ignored.</p>	<p>Software commands override control panel settings. (See page 48 for information about how your software works with control panel settings.)</p>
<p>Job went to a different bin than was expected.</p>	<p>The wrong size or type of paper was used for the job. (See page 256 for supported paper sizes.)</p>
<p>Job prints on the wrong side of the paper.</p>	<ul style="list-style-type: none"> ● Make sure you have loaded the paper correctly. (Starting on page 76.) ● If you are printing one-sided copies, load paper into Tray 1 with the side to be printed facing up. Load paper into Trays 2, 3, and the 2000-sheet Input Tray with the side to be printed facing down. ● If you are printing two-sided copies, load paper into Tray 1 with the first side to be printed facing down. Load paper into Trays 2, 3, and the 2000-sheet Input Tray with the first side to be printed facing up.





Problems with Tray 1

Situation	Solution
Cannot clear MANUALLY FEED [TYPE] [SIZE] message.	<ul style="list-style-type: none"> ● A previous print job may still be in the printer's buffer. ● Make sure that Tray 1 has the correct paper size loaded. For more information on paper specifications, see page 254.
Cannot print from Tray 1.	Make sure to select Manual Feed or Tray 1 through your software application and the size and type for which the tray is configured. For Manual Feed, wait for the printer to request the manual feed before loading the paper.
Paper is loaded into Tray 1, and the control panel displays a load or manual feed message.	Load the correct paper into the tray. See " Loading Tray 1 " on page 76 . If the correct paper is already loaded, press GO .
Paper is not going to the correct output bin.	<ul style="list-style-type: none"> ● Verify that the correct output bin is selected in the printer driver. For more information on changing printer driver settings, see the online help. ● The paper does not meet the specifications for the output bin. See page 256 for more information on paper specifications.





Problems with Trays 2, 3, and the Optional 2 x 500-sheet Input Tray (Trays 4 and 5)

Situation	Solution
General operation problems.	For general paper operation information, see Chapter 2, Printing Tasks .
Paper jams and paper feeding problems.	<ul style="list-style-type: none"> ● See Clearing Trays 2 and 3 or Clearing the Optional 2000-sheet Input Tray (Tray 4) earlier in this Chapter. ● Ensure that paper specifications are within recommended range (page 254).
Cannot access Trays 2, 3, or the Optional 2 x 500-sheet Input Tray (trays 4 and 5).	<ul style="list-style-type: none"> ● The appropriate paper size and type must be selected from the software application for the paper size loaded. ● Adjust the tray correctly for the paper size loaded. Check the Paper Handling Menu for correct type of paper available (page 283).
TRAY LOAD x [TYPE] [SIZE] paper size message.	Load the requested paper size or press SELECT to print on a size already loaded. The printer has a job in the buffer and is waiting to print on the correct paper size. Set the paper type in the control panel (page 279).



Problems with the Optional 2000-sheet Input Tray (Tray 4)

Situation	Solution
Paper size adjustment and installation.	See Paper Specifications on page 254 and Loading the Optional 2000-sheet Input Tray (Tray 4) on page 84 for more information on paper size adjustment and installation.
Paper jams and paper feeding problems.	<ul style="list-style-type: none"> ● See page 153. ● Ensure that paper specifications are within the recommended range (page 254). ● Verify that the paper type configured in the printer control panel for Tray 4 matches the paper loaded in Tray 4 (page 84). ● A tray might have been pulled out during printing. ● Check cables and connectors between the tray and the printer. See page 210 for cabling configurations. ● Remove and reconnect the power cord if it is not firmly plugged into the computer. ● Make sure trays are correctly loaded. ● Make sure the paper guides are adjusted properly, and not skewed (page 84).
Tray 4 will not power on.	<ul style="list-style-type: none"> ● The power cord is not firmly plugged into both the printer and the power receptacle. Remove and reconnect the power cord. ● Check cables and connectors between the tray and the printer. See page 210 for cabling configurations.



Problems with the Optional 2000-sheet Input Tray (Tray 4) (continued)



<p>Cannot access Tray 4.</p>	<p>Ensure that the paper tray guides are adjusted correctly for the paper size you are using (page 84).</p>
<p>Printer does not recognize Tray 4.</p>	<ul style="list-style-type: none"> ● Ensure the Optional 2000-sheet Input Tray has been configured in the printer driver. Refer to page 52 for more information on accessing the printer driver. ● Turn the printer off and then back on. ● Ensure that the cable from the Tray 4 base is plugged into the printer. If not, turn the printer off and plug the cable into the printer, then turn the printer back on. See page 210 for cabling configurations. ● Make sure the power cord is plugged into Tray 4. See page 210 for cabling configurations. ● If the printer still does not recognize Tray 4, contact your dealer or authorized HP service provider.
<p>Paper is not going to the correct output bin.</p>	<ul style="list-style-type: none"> ● Verify that the correct output bin is selected in the printer driver. For more information on changing printer driver settings, see the online help. ● The paper does not meet the specifications for the output bin. See page 256 for more information on paper specifications.



Problems with the Optional 5-bin Mailbox with Stapler



Situation	Solution
The job was not stapled.	Jobs sent to the stapler might not be stapled for one or more of the following reasons: <ul style="list-style-type: none"> ● The wrong size or type of paper was used for the job. ● More than 20 pages were sent to the stapler, exceeding its capacity. ● The stapler has bent or broken staples in the stapling bed. (See page 164.) ● A staple jam was recently cleared (up to 12 following jobs might not be stapled). ● The job was sent to a bin other than the stapler bin because the wrong size or type of paper was used for the job. ● One-page jobs will not be stapled. ● The interface cable between the mailbox and the stapler unit may be defective or not connected properly.
General repeated stapler jam problems.	<ul style="list-style-type: none"> ● Check to see that the job to be stapled is less than 2 mm thick. ● Stapler may have some trapped staple wires that are obstructing the magazine. Remove loose staples and paper dust from the inside of the stapler (page 164).



Problems with the Optional 5-bin Mailbox with Stapler (continued)

<p>Printer does not recognize the Mailbox with Stapler.</p>	<ul style="list-style-type: none"> ● Ensure that the Mailbox with Stapler has been configured in the printer driver. Refer to page 52 for more information on accessing the printer driver. ● Ensure that the cable from the Mailbox with Stapler is plugged into the printer parallel connector. If not, turn the printer off and plug the cable into the parallel connector, then turn the printer back on. See page 210 for cabling configurations. ● Ensure that all bins are properly installed. ● If the printer still does not recognize the Mailbox with Stapler, contact you dealer or authorized HP service provider.
<p>Printer does not recognize stapler.</p>	<ul style="list-style-type: none"> ● Check the cable between the printer and the stapler. Make sure it is properly connected at both ends. See page 210 for cabling configurations.
<p>The multibin mailbox will not power on.</p>	<ul style="list-style-type: none"> ● Verify that the power cord is firmly plugged into both the multibin mailbox and the power receptacle. Remove and reconnect the power cord. ● Ensure that the cable from the Mailbox with Stapler is plugged into the printer parallel connector. If not, turn the printer off and plug the cable into the parallel connector, then turn the printer back on. See page 210 for cabling configurations. ● Verify that the cables are firmly attached to the printer.



Problems with the Optional 5-bin Mailbox with Stapler (continued)

<p>Paper jams and paper feeding problems</p>	<ul style="list-style-type: none"> ● Ensure that you are using the supported paper weights (page 256). ● Do not pull paper out of the bins while printing. ● Check cables and connectors between the printer and the mailbox. See page 210 for cabling configurations. ● Repeated paper jams in the multibin mailbox area might indicate that the printer and multibin mailbox are set up on an uneven floor. Remove the toner cartridges, and then move the printer to a level location. Reinstall the toner cartridges.
<p>Paper is not going to the correct output bin.</p>	<ul style="list-style-type: none"> ● Verify that the correct output bin is selected in the printer driver. For more information on changing printer driver settings, see the online help. ● The paper does not meet the specifications for the output bin. See page 256 for more information on paper specifications. ● If you are trying to send print jobs to an optional multibin mailbox, verify that the multibin mailbox has been installed on the printer and in the printer driver. Also verify the multibin mailbox mode, which will affect the print job destination.





Problems with the Optional Multibin Mailbox (8 bins)

<p>Printer does not recognize the Mailbox.</p>	<ul style="list-style-type: none"> ● Ensure that the 8-bin Mailbox has been configured in the printer driver. Refer to page 52 for more information on accessing the printer driver. ● Ensure that the cable from the 8-bin Mailbox is plugged into the printer parallel connector. If not, turn the printer off and plug the cable into the parallel connector, then turn the printer back on. See page 210 for cabling configurations. ● Ensure that all bins are properly installed. ● If the printer still does not recognize the 8-bin Mailbox, contact your dealer or authorized HP service provider.
<p>Paper jams and paper feeding problems</p>	<ul style="list-style-type: none"> ● Ensure that you are using the supported paper weights (page 256). ● Do not pull paper out of the bins while printing. ● Check cables and connectors between the printer and the mailbox. See page 210 for cabling configurations. ● Repeated paper jams in the multibin mailbox area might indicate that the printer and multibin mailbox are set up on an uneven floor. Remove the toner cartridges, and then move the printer to a level location. Reinstall the toner cartridges.

Problems with the Optional Multibin Mailbox (8 bins) (continued)

<p>Paper is not going to the correct output bin.</p>	<ul style="list-style-type: none"> ● Verify that the correct output bin is selected in the printer driver. For more information on changing printer driver settings, see the online help. ● The paper does not meet the specifications for the output bin. See page 256 for more information on paper specifications. ● If you are trying to send print jobs to an optional multibin mailbox, verify that the multibin mailbox has been installed on the printer and in the printer driver. Also verify the multibin mailbox mode, which will affect the print job destination.
<p>The multibin mailbox will not power on.</p>	<ul style="list-style-type: none"> ● Verify that the power cord is firmly plugged into both the multibin mailbox and the power receptacle. Remove and reconnect the power cord. ● Ensure that the cable from the multibin mailbox is plugged into the printer parallel connector. If not, turn the printer off and plug the cable into the parallel connector, then turn the printer back on. See page 210 for cabling configurations. ● Verify that the cables are firmly attached to the printer.





Problems with the Optional 7-bin Tabletop Mailbox

<p>Printer does not recognize the mailbox.</p>	<ul style="list-style-type: none"> ● Ensure that the 7-bin Mailbox has been configured in the printer driver. Refer to page 52 for more information on accessing the printer driver. ● Ensure that the cable from the 7-bin Mailbox is plugged into Tray 4. If not, turn the printer off and plug the cable into Tray 4, then turn the printer back on. See page 210 for cabling configurations. ● Ensure that all bins are properly installed. ● If the printer still does not recognize the 7-bin Mailbox, contact your dealer or authorized HP service provider.
<p>Paper jams and paper feeding problems</p>	<ul style="list-style-type: none"> ● Ensure that you are using the supported paper weights (page 256). ● Do not pull paper out of the bins while printing. ● Check cables and connectors between the printer and the mailbox. See page 210 for cabling configurations. ● Repeated paper jams in the multibin mailbox area might indicate that the printer and multibin mailbox are set up on an uneven floor. Remove the toner cartridges, and then move the printer to a level location. Reinstall the toner cartridges.

Problems with the Optional 7-bin Tabletop Mailbox (continued)

<p>Paper is not going to the correct output bin.</p>	<ul style="list-style-type: none"> ● Verify that the correct output bin is selected in the printer driver. For more information on changing printer driver settings, see the online help. ● The paper does not meet the specifications for the output bin. See page 256 for more information on paper specifications. ● If you are trying to send print jobs to an optional multibin mailbox, verify that the multibin mailbox has been installed on the printer and in the printer driver. Also verify the multibin mailbox mode, which will affect the print job destination.
<p>The multibin mailbox will not power on.</p>	<ul style="list-style-type: none"> ● Verify that the power cord is firmly plugged into both the multibin mailbox and the power receptacle. Remove and reconnect the power cord. ● Ensure that the cable from the 7-bin Mailbox is plugged into Tray 4. If not, turn the printer off and plug the cable into Tray 4, then turn the printer back on. See page 210 for cabling configurations. ● Verify that the cables are firmly attached to the printer.



Cabling Configurations

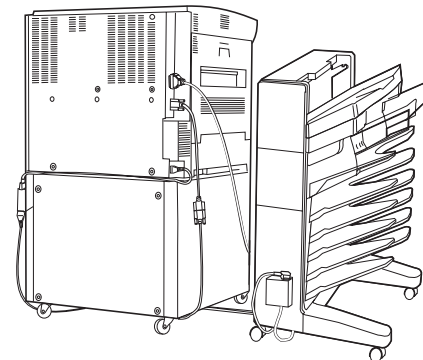
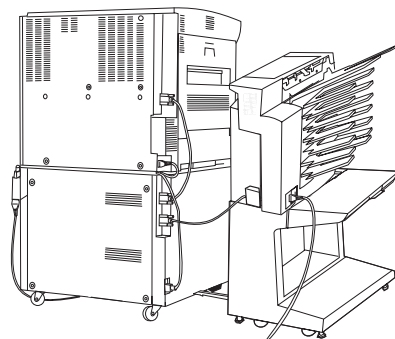
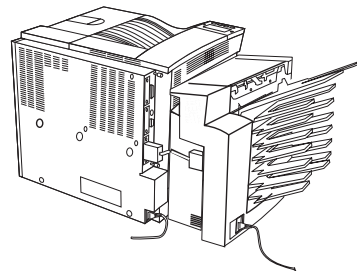
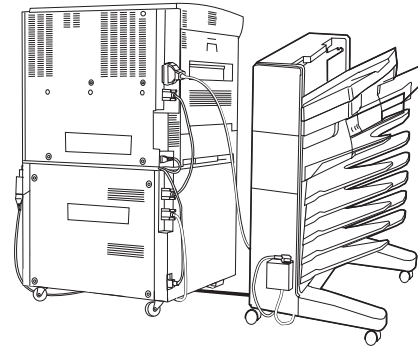
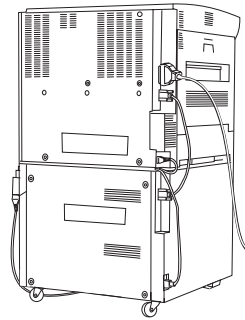



Problems with the Optional Duplex Printing Accessory

Printer does not recognize the duplexer	<ul style="list-style-type: none"> ● Remove and re-install the unit. ● Be sure that the duplexer has been configured in the printer driver. ● Print a configuration page to check that the unit is present.
Job did not duplex	<ul style="list-style-type: none"> ● Check that the duplexer is installed. ● Be sure the duplexer has been configured in the printer driver. ● Make sure that the software is not overriding the printer driver setting.
Duplexer jams	<ul style="list-style-type: none"> ● Ensure that you are using the supported paper weights (page 256).



Problems with the Optional Envelope Feeder

Situation	Solution
Envelope jams and envelope feeding problems.	<ul style="list-style-type: none"> ● Make sure the envelopes are within the specifications listed on page 267. ● Make sure the envelopes are properly loaded. ● Make sure the envelope weight on the feeder is down. ● Make sure the Optional Envelope Feeder extension is fully pulled out.
Multiple envelopes feed into the printer.	<ul style="list-style-type: none"> ● The first envelope to be fed must be closer to the pick up roller than the others.



Determining Printer Problems

Problems with the Optional Envelope Feeder (continued)

No Envelopes are fed into the printer	<ul style="list-style-type: none"> ● Make sure you are not overloading the envelope feeder. ● When loading the envelopes, be sure to push them all the way down to touch the rollers.
Printer does not recognize the Optional Envelope Feeder.	<ul style="list-style-type: none"> ● Turn the printer off, remove and re-install the Optional Envelope Feeder, then turn the printer back on. ● Ensure the Optional Envelope Feeder has been configured in the printer driver. Refer to page 55 for more information on accessing the printer driver.

**Printer Hard Disk**

Situation	Solution
Printer does not recognize the hard disk.	Turn the printer off and verify that the hard disk is inserted correctly and is securely fastened.
Disk is not initialized. DISK x NOT INITIALIZED	Use the Windows-based HP JetAdmin utility, the HP LaserJet Resource Manager, or the Macintosh-based HP LaserJet Utility to initialize the disk.
Disk failure. EIO x DISK NOT FUNCTIONING	Turn the printer off and verify that the EIO disk is inserted correctly and securely fastened. If the control panel message continues to be displayed, the disk drive needs to be replaced.



Printer Hard Disk (continued)

<p>Disk is write protected. DISK IS WRITE PROTECTED</p>	<p>Fonts and forms cannot be stored on the disk when the disk is write protected. Use the Windows-based HP JetAdmin utility or the Macintosh-based HP LaserJet Utility to download the font.</p>
<p>Attempted to use a disk-resident font, but the printout substituted a different font.</p>	<p>If you are using PCL, print the PCL Font Page, and verify that the font is on the disk. If you are using PS, print the PS Font Page and verify that the font is on the disk. If the font is not on the disk, use the HP LaserJet Resource Manager, FontSmart, or the Macintosh-based HP LaserJet Utility to download the font.</p>



PS Troubleshooting

Situation	Solution
<p>A text listing of PS commands prints instead of your PS printing job.</p>	<p>The control panel PERSONALITY=AUTO setting may have been confused by a nonstandard PS code. Check the PERSONALITY setting to see if it is set to PS or PCL. If it is set to PCL, set it to PERSONALITY=AUTO. If it is set to AUTO, set it to PS for this print job only. When the job has printed, return the setting to AUTO.</p>



PS Troubleshooting (continued)

<p>The job prints in Courier (the printer's default font) instead of the font you requested.</p>	<ul style="list-style-type: none"> ● The requested typeface is not available in the printer or is not present on the disk. Use a font download utility to download the desired font. ● Fonts downloaded to memory are lost when the printer is turned off. They are also lost if Resource Saving is not used and a personality switch is performed to print a PCL job. Disk fonts are not affected by PCL jobs or by turning the printer to off. ● Print a PS Font Page to verify that the font is available. If a disk font appears to be missing, it may be because a software utility was used to delete the font, because the disk was re-initialized, or because the disk drive is not installed correctly. Print a configuration page to verify that the disk drive is installed and functioning correctly. ● Print a Disk Directory to help identify available fonts.
<p>A page prints with clipped margins.</p>	<p>If the page margins are clipped, you may have to print the page at 300-dpi resolution or install more memory. Also try turning off Resource Saving and I/O Buffering.</p>
<p>A page fails to print.</p>	<p>Set <code>PRINT PS ERRORS=ON</code>, and then send the job again to print a PS error page. If this does not identify the problem try turning off Resource Saving and I/O Buffering, or installing more memory. (See page 232 for more information about PS printing.)</p>



PS Troubleshooting (continued)

<p>A PS error page prints.</p>	<p>Make sure the print job is a PS job. Check to see whether your software expected you to send a setup or PS header file to the printer. Check the printer setup in your software application to ensure that the printer is selected. Check cable connections to ensure that they are secure. Reduce the complexity of the graphic. Increase available memory by turning off Resource Saving.</p>
--------------------------------	--



Computer, Network, or I/O Port Problems

Situation	Solution
<p>Printer Interface problems</p>	<p>Print a configuration page from the printer's control panel to verify that the interface configurations shown on the printout match those on the host computer. (See page 228 to print a configuration page.)</p>
<p>Computer software problem</p>	<p>Check that your computer is working correctly by printing from a software application you know works or by printing a plain text file to see if the problem is with your software application or printer driver. (For example, C:\dir>>LPTn where n is the number of the computer port the printer is connected to, for example LPT1.) To output the page, you may have to send a form feed command from your computer.</p>



Determining Printer Problems

Computer, Network, or I/O Port Problems (continued)

Software is selecting the wrong port.	Check your operating system's port settings to be sure the print job is being sent to the correct port (for example, LPT1).
Printer port problem	Check that your computer's port is configured and working properly. One way to check this is to connect another printer to that port on your computer and print an application you know works.
Network or shared printer problems	Check for network or shared printer problems by connecting your computer directly to the printer and printing from an application you know works. If you suspect network problems, check with your network administrator or consult the network documentation that came with your printer network card(s).
Computer displays DOS messages such as: Write Fault Error Writing Device LPTn: Abort, Retry, Ignore?	<ul style="list-style-type: none"> ● Add a Mode command to your computer's AUTOEXEC.BAT file for the parallel port. It should be inserted immediately following the PATH statement: For DOS versions below 4.0, add: <code>MODE LPT1: ,P</code> For DOS versions 4.0 and above, add: <code>MODE LPT1: ,B</code> ● The I/O cable might be faulty; see "Printing is Incomplete or Incorrect" on page 194.



Macintosh Problem Solving

<p>The Macintosh computer is not communicating with the printer.</p>	<ul style="list-style-type: none"> ● Make sure the printer's control panel displays READY. ● Make sure the correct printer driver is selected in the Chooser. (There will be an icon beside the name.) ● If the printer resides on a network with multiple zones, make sure the correct zone is selected in the AppleTalk Zones box in the Chooser. ● Make sure the correct printer has been chosen in the Chooser by printing a configuration page (page 228). Make sure the name of the printer displayed on the configuration page matches the printer in the Chooser. ● Make sure AppleTalk is active. (Select this in the Chooser.) ● Make sure the computer and printer are on the same network. From Control Panels in the Apple menu, select the Network (or the AppleTalk) control panel and then choose the correct network (for example, LocalTalk or EtherTalk).
<p>Auto Setup did not automatically set up the printer.</p>	<ul style="list-style-type: none"> ● Set up the printer manually by selecting Configure. ● Reinstall the printer software (page 62). ● Select an alternate PPD (page 219). ● The PPD might have been renamed. If so, select the renamed PPD (page 219).
<p>The printer driver icon does not appear in the Chooser.</p>	<p>Make sure the LaserWriter Chooser extension resides in the Extensions folder. If it is not present anywhere on your system, then obtain the Macintosh LaserWriter driver from Apple.</p>

**Determining Printer Problems**

Macintosh Problem Solving (continued)

<p>The print job is not sent to the desired printer.</p>	<p>Another printer with the same or similar name might have received the print job. Verify that the printer name matches the name selected in the Chooser (page 219).</p>
<p>The print job has incorrect fonts.</p>	<ul style="list-style-type: none"> ● If you are printing an .EPS file, try downloading the fonts contained in the .EPS file to the printer before printing. Use the HP LaserJet Utility (page 69). ● If the document is not printing with New York, Geneva, or Monaco fonts, go into the Page Setup dialog box, and select Options to deselect substituted fonts.



Selecting an alternate PPD

1. Open the **Chooser** from the **Apple** menu.
2. Click the **LaserWriter** icon.
3. If you are on a network with multiple zones, select the zone in the **AppleTalk Zones** box where the printer is located.
4. Click the printer name you want to use in the **Select a PostScript Printer** box. (Double-clicking will immediately generate the next few steps.)
5. Click **Setup...** (This button might read **Create** for first-time setup.)
6. Click **Select PPD...**
7. Find the desired PPD in the list and click **Select**. If the desired PPD is not listed, choose one of the following options:
 - ◆ Select a PPD for a printer with similar features.
 - ◆ Select a PPD from another folder.
 - ◆ Select the generic PPD by clicking **Use Generic**. The generic PPD allows you to print, but limits your access to printer features.
8. In the **Setup** dialog box, click **Select**, and then click **OK** to return to the **Chooser**.

Note

If you manually select a PPD, an icon might not appear next to the selected printer in the **Select a PostScript Printer** box. In the **Chooser**, click **Setup**, click **Printer Info**, and then click **Update Info** to bring up the icon.

9. Close the **Chooser**.



Renaming the Printer

If you are going to rename the printer, do this before selecting the printer in the **Chooser**. If you rename the printer after selecting it in the **Chooser**, you will have to go back into the **Chooser** and reselect it.

Use the **Set Printer Name** feature in the **HP LaserJet Utility** to rename the printer.



Communicating with an Optional HP JetDirect 600N Print Server

If the printer contains an optional HP JetDirect internal print server, and you cannot communicate with the printer over the network, verify operation of the print server. Check the JetDirect Configuration Page for the message I/O CARD READY. (Follow the steps on page [228](#) to print a configuration page.) For troubleshooting information, refer to the HP JetDirect software installation guide.

HP JetDirect 600N 10/100Base-TX Print Server

If the printer contains an optional HP JetDirect 10/100Base-TX print server, check to see that the print server was able to link to the network.

- Check the link-speed LEDs (10 or 100) on the print server. If both are off, the card failed to link to the network.

Continued on next page.



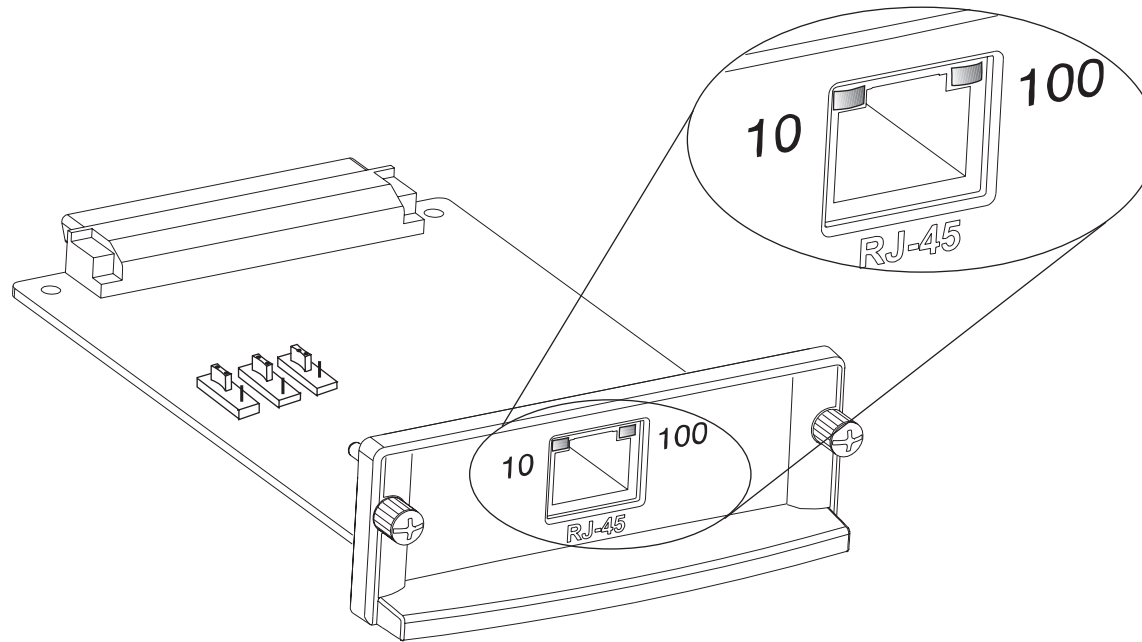

- Check the JetDirect Configuration Page for a `LOSS OF CARRIER` error message. This message also indicates that the card did not link to the network.

Note

The HP JetDirect 10/100Base-TX print server may require up to 10 seconds to establish a link to the network.

If the print server failed to link, verify that all cables are correctly connected. If the print server still fails to link, follow the steps below to reconfigure the print server.

Continued on next page.



1. Remove the HP JetDirect 10/100TX print server.

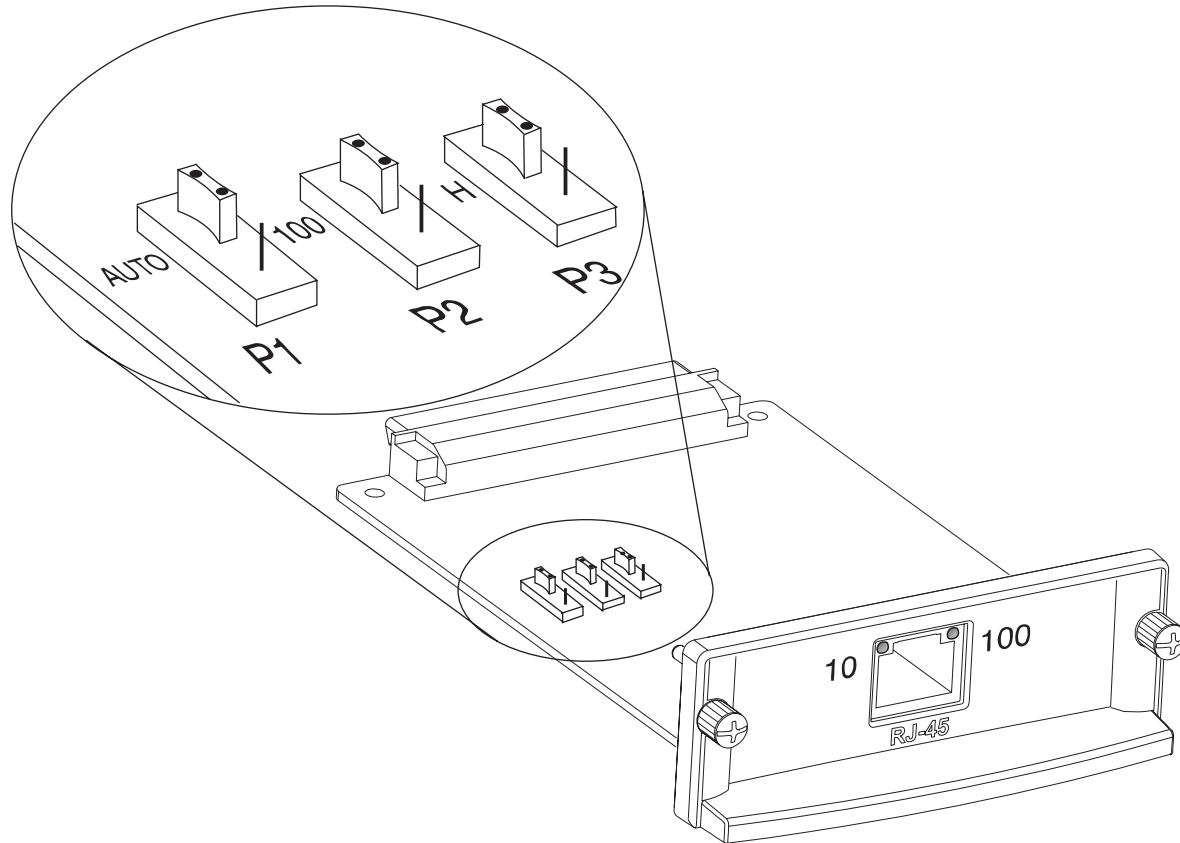

2. Use jumpers P1, P2, and P3 to manually configure the print server for either 10 or 100 Mb per second link speed, and Full-duplex or Half-duplex operation according to the table below.

Continued on next page.



Operation	Jumper P1	Jumper P2	Jumper P3
Autonegotiation Enabled	AUTO		
100 Half-duplex	<not Auto>	100	H
100 Full-duplex	<not Auto>	100	<not H>
10 Half-duplex	<not Auto>	<not 100>	H
10 Full-duplex	<not Auto>	<not 100>	<not H>

Continued on next page.



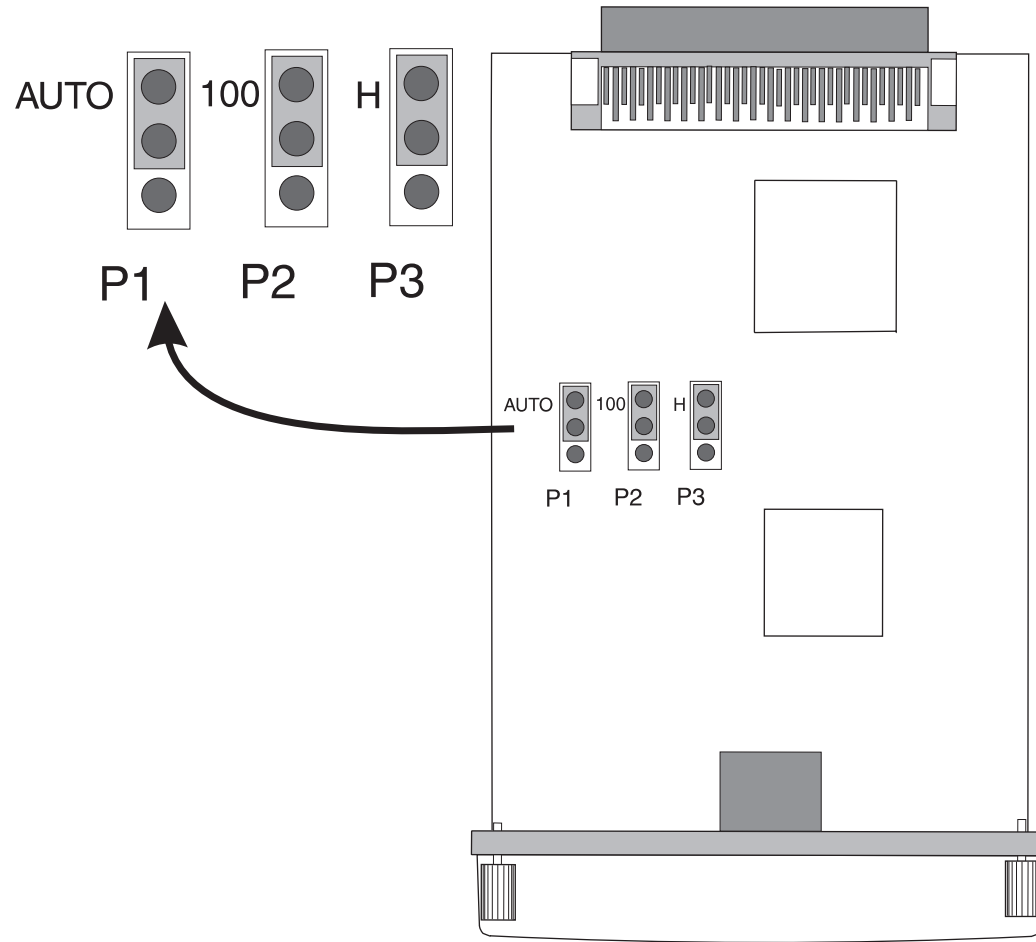

Continued on next page.



3. Reinstall the print server.
4. Verify that the configuration of the connecting network device (such as a 10/100TX network switch) matches. For example, to set the print server for 100TX Full-duplex operation, the port on the network switch must also be set for 100TX Full-duplex operation.
5. Turn the printer off and back on
6. Check the print server operation. If the print server fails to link, contact a local authorized HP dealer or service representative.



Checking the Printer's Configuration

From the printer's control panel, you can print pages that give details about the printer and its current configuration. The following information pages are described here:

- [Configuration Page](#)
- [Menu Map](#)
- [PCL or PS Font List](#)

For a complete list of the printer's information pages, see the Information Menu in the printer's control panel (page [281](#)).



Configuration Page

Use the configuration page to view current printer settings, to help troubleshoot printer problems, or to verify installation of optional accessories, such as memory (DIMMs), input and output paper handling devices, and printer languages.

Note If an HP JetDirect print server card is installed (HP LaserJet 8000 N/8000 DN printers), a JetDirect configuration page will print out as well.

To print a configuration page:

1. Press **MENU** repeatedly until **INFORMATION MENU** appears.
2. Press **ITEM** repeatedly until **PRINT CONFIGURATION** appears.
3. Press **SELECT** to print the configuration page.

Numbers in the sample printout match the numbers in the printer messages (page [169](#)). The content of the configuration page varies, depending on the options currently installed in the printer.



Configuration Page

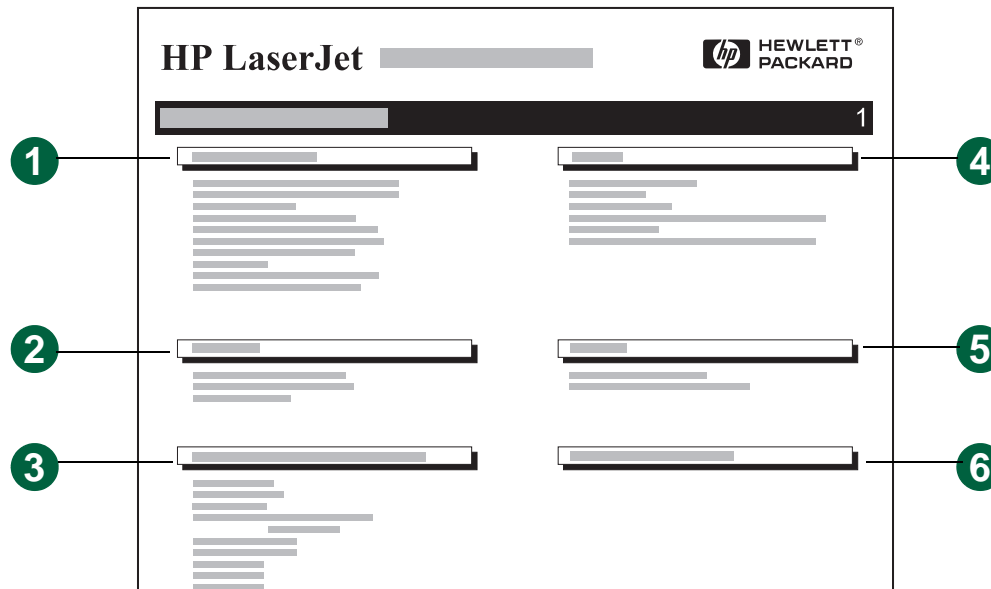

1. **Printer Information** lists the serial number, HP JetSend IP addresses, page counts, and other information for the printer.
2. **Event Log** lists the number of entries in the log, the maximum number of entries viewable, and the last three entries.
3. **Installed Personalities and Options** lists all printer languages that are installed (such as PCL and PS) and lists options that are installed in each DIMM slot and EIO slot.

Continued on next page.



4. **Memory** lists the printer memory, PCL Driver Work Space (DWS), and I/O buffering and resource saving information.
5. **Security** lists the status of the printer's control panel lock, control panel password, and disk drive.
6. **Paper Trays and Options** lists the size settings for all trays and lists optional paper handling accessories that are installed.



Menu Map

To see the current settings for the menus and items available in the control panel, print a control panel menu map:

1. Press **MENU** repeatedly until **INFORMATION MENU** appears.
2. Press **ITEM** repeatedly until **PRINT MENU MAP** appears.
3. Press **SELECT** to print the menu map.

You might want to store the menu map near the printer for reference. The content of the menu map varies, depending on the options currently installed in the printer. (Many of these values can be overridden from the printer driver or software application.)

For a complete list of control panel items and possible values, see page [279](#). To change a control panel setting, see page [48](#).



PCL or PS Font List

Use the font lists to see which fonts are currently installed in the printer. (The font lists also show which fonts are resident on an optional hard disk or flash DIMM.)

To print a PCL or PS font list:

1. Press **MENU** repeatedly until INFORMATION MENU appears.
2. Press **ITEM** repeatedly until PRINT PCL FONT LIST or PRINT PS FONT LIST appears.
3. Press **SELECT** to print the font list.

The PS font list shows the PS fonts installed, and gives a sample of those fonts. The following describes the information that can be found on the PCL font list:

- **Font** gives the font names and samples.
- **Pitch/Point** indicates the pitch or point size of the font.
- **Escape Sequence** (a PCL programming command) is used to select the designated font. (See the legend at the bottom of the font list page.)

Note For step-by-step instructions on using printer commands to select a font with DOS applications, see page [327](#).

Continued on next page.



- **Font #** is the number used to select fonts from the printer's control panel (not the software application). Do not confuse the font # with the font ID, described below. The number indicates the DIMM slot where the font is stored.
- **SOFT**: Downloaded fonts, which stay resident in the printer until other fonts are downloaded to replace them, or until the printer is turned off.
- **INTERNAL**: Fonts that permanently reside in the printer.
- **Font ID** is the number you assign to soft fonts when you download them through software.



File Directory Page

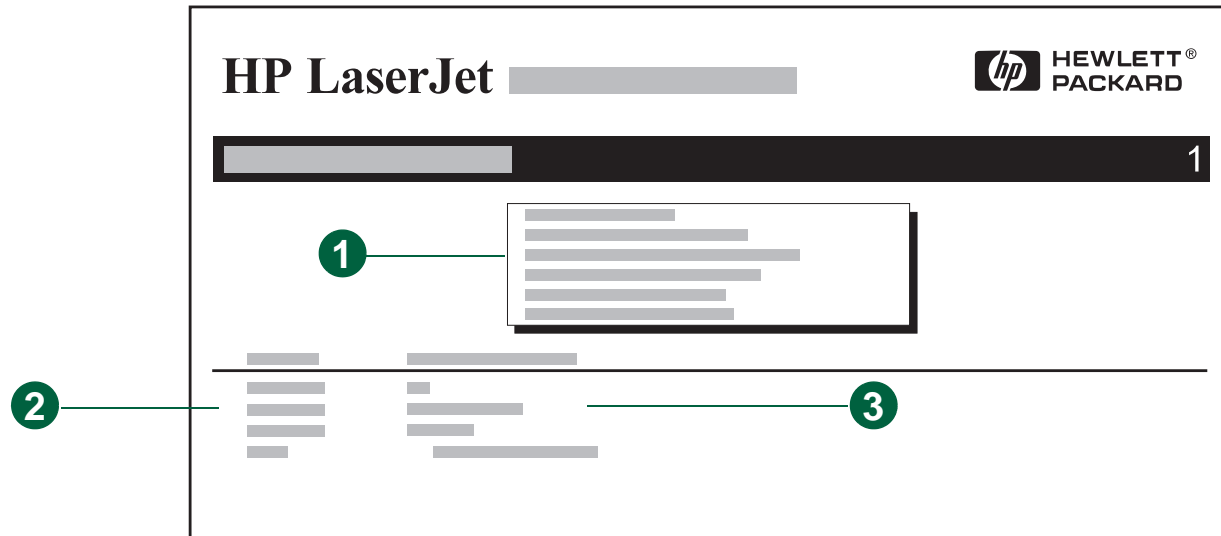

1. **Disk Information** indicates the disk model number, serial number, capacity, available free space, and whether you may write to the disk.
2. **File Size** column lists the size of each file under the Directory/File Name column. If a directory is listed on the line, then Directory appears in this column and its path is listed in the Directory/File Name column.
3. **Directory/File Name** lists the name of the file. Files in a subdirectory are listed right after the directory line. The files are not necessarily listed in alphabetic order.



Event Log Page

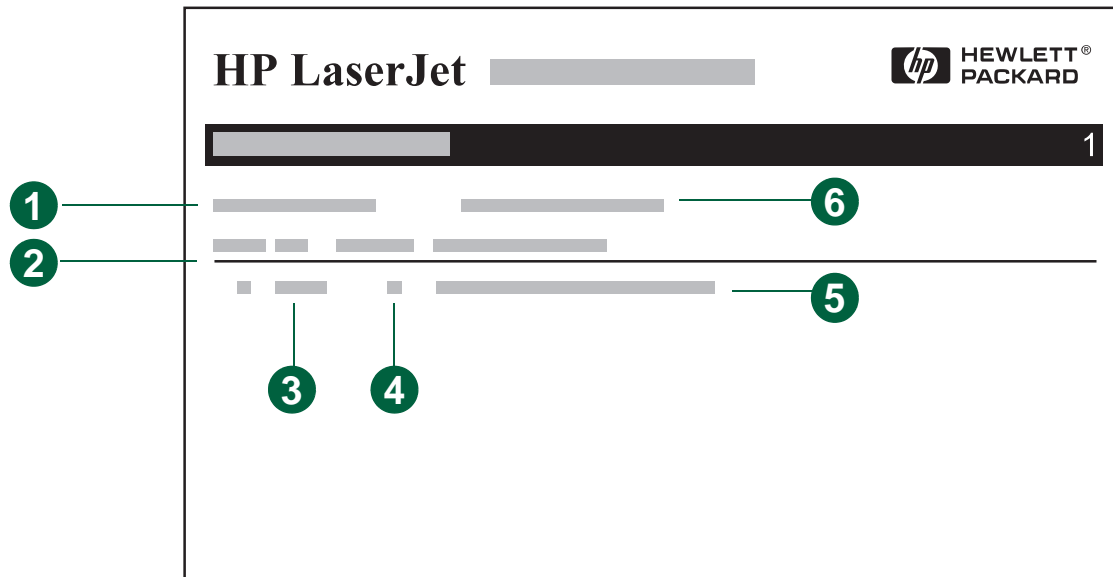

1. **Current Page Count** lists the number of printed pages from the printer.
2. **Number** indicates the order in which the errors occurred. The last error to occur has the highest number.
3. **Error** lists the internal error code for each error.
4. **Page Count** indicates the number of printed pages from the printer when the error occurred.
5. **Description or Personality** indicates whether the error occurred due to a problem within a printer personality or a printer jam.
6. **Serial Number** shows the serial number of the printer.



6 Service and Support

Overview

- [Hewlett-Packard limited warranty statement](#)
- [Limited Warranty for Toner Cartridge Life](#)
- [HP Software License Terms](#)
- [Worldwide Sales and Service Offices](#)



Hewlett-Packard limited warranty statement

HP PRODUCT

HP LaserJet 8000

DURATION OF WARRANTY

1 year, on-site

1. HP warrants HP hardware, accessories, and supplies against defects in materials and workmanship for the period specified above. If HP receives notice of such defects during the warranty period, HP will, at its option, either repair or replace products which prove to be defective. Replacement products may be either new or like-new.
2. HP warrants that HP software will not fail to execute its programming instructions, for the period specified above, due to defects in material and workmanship when properly installed and used. If HP receives notice of such defects during the warranty period, HP will replace software media which does not execute its programming instructions due to such defects.
3. HP does not warrant that the operation of HP products will be uninterrupted or error free. If HP is unable, within a reasonable time, to repair or replace any product to a condition as warranted, customer will be entitled to a refund of the purchase price upon prompt return of the product.
4. HP products may contain remanufactured parts equivalent to new in performance or may have been subject to incidental use.
5. The warranty period begins on the date of the delivery or on the date of installation if installed by HP. If customer schedules or delays HP installation more than 30 days after delivery, warranty begins on the 31st day from delivery.



6. Warranty does not apply to defects resulting from (a) improper or inadequate maintenance or calibration, (b) software, interfacing, parts or supplies not supplied by HP, (c) unauthorized modification or misuse, (d) operation outside of the published environmental specifications for the product, or (e) improper site preparation or maintenance.
7. TO THE EXTENT ALLOWED BY LOCAL LAW, THE ABOVE WARRANTIES ARE EXCLUSIVE AND NO OTHER WARRANTY, WHETHER WRITTEN OR ORAL, IS EXPRESSED OR IMPLIED AND HP SPECIFICALLY DISCLAIMS THE IMPLIED WARRANTIES OR CONDITIONS OF MERCHANTABILITY, SATISFACTORY QUALITY, AND FITNESS FOR A PARTICULAR PURPOSE.
8. HP will be liable for damage to tangible property per incident up to the greater of \$300,000 or the actual amount paid for the product that is the subject of the claim, and for damages for bodily injury or death, to the extent that all such damages are determined by a court of competent jurisdiction to have been directly caused by a defective HP product.
9. TO THE EXTENT ALLOWED BY LOCAL LAW, THE REMEDIES IN THIS WARRANTY STATEMENT ARE THE CUSTOMER'S SOLE AND EXCLUSIVE REMEDIES. EXCEPT AS INDICATED ABOVE, IN NO EVENT WILL HP OR ITS SUPPLIERS BE LIABLE FOR LOSS OF DATA OR FOR DIRECT, SPECIAL, INCIDENTAL, CONSEQUENTIAL (INCLUDING LOST PROFIT OR DATA), OR OTHER DAMAGE, WHETHER BASED IN CONTRACT, TORT, OR OTHERWISE.
10. FOR CONSUMER TRANSACTIONS IN AUSTRALIA AND NEW ZEALAND; THE WARRANTY TERMS CONTAINED IN THIS STATEMENT, EXCEPT TO THE EXTENT LAWFULLY PERMITTED, DO NOT EXCLUDE, RESTRICT OR MODIFY AND ARE IN ADDITION TO THE MANDATORY STATUTORY RIGHTS APPLICABLE TO THE SALE OF THIS PRODUCT TO YOU.



Service During and After the Warranty Period

- If printer hardware fails during the warranty period, contact an HP-authorized service or support provider. (See the [HP Support](#) pages at the front of this user guide.)
- If printer hardware fails after the warranty period, and you have an HP Maintenance Agreement or HP SupportPack, request service as specified in the agreement.
- If you do not have an HP Maintenance Agreement or HP SupportPack, contact an HP-authorized service or support provider. (See the [HP Support](#) pages at the front of this user guide.)



Limited Warranty for Toner Cartridge Life



Note The warranty below applies to the toner cartridge that came with this printer.

This warranty supersedes all previous warranties (7/19/96).



HP toner cartridges are warranted to be free from defects in materials and workmanship until the HP toner is depleted. The warranty covers any defects or malfunctions in a new Hewlett-Packard toner cartridge.



How long does the coverage last?

The coverage lasts until the HP toner is depleted, at which time the warranty expires.

How do I know when the HP toner is running out?

The `TONER LOW` message on the printer's control panel display provides the first indication that toner is low. (Toner will likely run out in the next 100-300 sheets of paper.)

What will HP do?

HP will, at HP's option, either replace products which prove to be defective or refund the purchase price. If possible, please attach a print-out sample illustrating what the defective cartridge is printing.

What does this warranty not cover?

The warranty does not cover cartridges which have been refilled, are emptied, are abused, are misused, or are tampered with in any way.



How do I return the faulty cartridge?

In the event the cartridge proves to be defective, return the cartridge to the place of purchase, where the cartridge will be replaced (include a print sample illustrating the defect).

How does State, Province or Country Law apply?

This limited warranty gives you specific legal rights, and you may also have other rights which vary from state to state, province to province, or country to country. This limited warranty is the sole warranty on the HP toner cartridge and supersedes any other warranty relating to this product.

IN NO EVENT SHALL HEWLETT-PACKARD COMPANY BE LIABLE FOR ANY INCIDENTAL, CONSEQUENTIAL, SPECIAL, INDIRECT, PUNITIVE, OR EXEMPLARY DAMAGES OR LOST PROFITS FROM ANY BREACH OF THIS WARRANTY OR OTHERWISE.



HP Software License Terms

ATTENTION: USE OF THE SOFTWARE IS SUBJECT TO THE HP SOFTWARE LICENSE TERMS SET FORTH BELOW. USING THE SOFTWARE INDICATES YOUR ACCEPTANCE OF THESE LICENSE TERMS. IF YOU DO NOT ACCEPT THESE LICENSE TERMS, YOU MAY RETURN THE SOFTWARE FOR A FULL REFUND. IF THE SOFTWARE IS BUNDLED WITH ANOTHER PRODUCT, YOU MAY RETURN THE ENTIRE UNUSED PRODUCT FOR A FULL REFUND.

The following License Terms govern your use of the accompanying Software unless you have a separate signed agreement with HP.

License Grant

HP grants you a license to Use one copy of the Software. “Use” means storing, loading, installing, executing, or displaying the Software. You may not modify the Software or disable any licensing or control features of the Software. If the Software is licensed for “concurrent use”, you may not allow more than the maximum number of authorized users to Use the Software concurrently.

Ownership

The Software is owned and copyrighted by HP or its third party suppliers. Your license confers no title to, or ownership in, the Software and is not a sale of any rights in the Software. HP’s third party suppliers may protect their rights in the event of any violation of these License Terms.



Copies and Adaptations

You may only make copies or adaptations of the Software for archival purposes or when copying or adaptation is an essential step in the authorized Use of the Software. You must reproduce all copyright notices in the original Software on all copies or adaptations. You may not copy the Software onto any public network.



No Disassembly or Decryption

You may not disassemble or decompile the Software unless HP's prior written consent is obtained. In some jurisdictions, HP's consent may not be required for limited disassembly or decompilation. Upon request, you will provide HP with reasonably detailed information regarding any disassembly or decompilation. You may not decrypt the Software unless decryption is a necessary part of the operation of the Software.



Transfer

Your license will automatically terminate upon any transfer of the Software. Upon transfer, you must deliver the Software, including any copies and related documentation, to the transferee. The transferee must accept these License Terms as a condition to the transfer.



Termination

HP may terminate your license upon notice for failure to comply with any of these License Terms. Upon termination, you must immediately destroy the Software, together with all copies, adaptations, and merged portions in any form.

Export Requirements

You may not export or reexport the Software or any copy or adaptation in violation of any applicable laws or regulations.

U.S. Government Restricted Rights

The Software and any accompanying documentation have been developed entirely at private expense. They are delivered and licensed as “commercial computer software” as defined in DFARS 252.227-7013 (Oct 1988), DFARS 252.211-7015 (May 1991), or DFARS 252.227-7014 (Jun 1995), as a “commercial item” as defined in FAR 2.101 (a), or as “Restricted computer software” as defined in FAR 52.227-19 (Jun 1987) (or any equivalent agency regulation or contract clause), whichever is applicable. You have only those rights provided for such Software and any accompanying documentation by the applicable FAR or DFARS clause or the HP standard software agreement for the product involved.



Worldwide Sales and Service Offices

Note

Before calling an HP Sales and Service office, be sure to contact the appropriate Customer Support Center number listed in the “HP Support” section. Products should not be returned to these offices. Product return information is also available through the appropriate Customer Support Center in [HP Support](#) section.

Argentina

Hewlett-Packard Argentina S.A.
Montañeses 2140/50/60
1428 Buenos Aires
Phone:(54) (1) 787-7100
Fax:(54) (1) 787-7213

Phone: (61) (3) 272-2577
Customer Information Center:
Phone:(61) (3) 272-8000

Australia

Hewlett-Packard Australia Ltd.
31-41 Joseph Street
Blackburn, VIC 3130
Phone:(61) (3) 272-2895
Fax:(61) (3) 898-7831
Hardware Repair Center:
Phone:(61) (3) 272-8000
Extended Warranty Support:

Austria

Hewlett-Packard GmbH
Lieblgasse 1
A-1222 Vienna
Phone:(43) (1) 25000-555
Fax:(43) (1) 25000-500

Belgium

Hewlett-Packard Belgium S.A. NV
Boulevard de la Woluwe-Woluwedal 100-102



B-1200 Brussels
 Phone:(32) (2) 778-31-11
 Fax:(32) (2) 763-06-13

Brazil

Edisa Hewlett-Packard SA
 Alameda Rio Negro 750
 06454-050 Alphaville - Barueri-SP
 Phone: (55) (11)- 7296-8000

Canada

Hewlett-Packard (Canada) Ltd.
 17500 Trans Canada Highway
 South Service Road
 Kirkland, Québec H9J 2X8
 Phone:(1) (514) 697-4232
 Fax:(1) (514) 697-6941

Hewlett-Packard (Canada) Ltd.
 5150 Spectrum Way
 Mississauga, Ontario L4W 5G1
 Phone:(1) (905) 206-4725
 Fax:(1) (905) 206-4739

Chile

Hewlett-Packard de Chile
 Avenida Andres Bello 2777 of. 1
 Los Condes
 Santiago, Chile

China

China Hewlett-Packard Co. Ltd.
 Level 5, West Wing Office
 China World Trade Center
 No. 1, Jian Guo Men Wai Avenue
 Beijing 100004
 Phone:(86) (10) 6505-3888,x. 5450
 Fax:(86) (10) 6505-1033
 Hardware Repair Center and Extended
 Warranty Support:
 Phone:(86) (10) 6262-5666x. 6101/2
 (86) (10) 6261-4167

Colombia

Hewlett-Packard Colombia
 Calle 100 No. 8A -55
 Torre C Oficina 309
 Bogota, Colombia



Czech Republic

Hewlett-Packard s. r. o.
 Novodvorská 82
 CZ-14200 Praha 4
 Phone:(42) (2) 613-07111
 Fax:(42) (2) 471-7611

Denmark

Hewlett-Packard A/S
 Kongevejen 25
 DK-3460 Birkerød
 Denmark
 Phone:(45) 3929 4099
 Fax:(45) 4281-5810

Far East Region

Hewlett-Packard Asia Pacific Ltd.
 17-21/F Shell Tower, Times Square
 1 Matheson Street, Causeway Bay
 Hong Kong
 Phone:(852) 2599-7777

Fax:(852) 2506-9261
 Hardware Repair Center:
 Phone:(852) 2599-7000
 Extended Warranty Support:
 Phone:(852) 2599-7000
 Customer Information Center:
 Phone:(852) 2599-7066

Finland

Hewlett-Packard Oy
 Piispankalliontie 17
 FIN-02200 Espoo
 Phone:(358) (9) 887-21
 Fax:(358) (9) 887-2477

France

Hewlett-Packard France
 42 Quai du Point du Jour
 F-92659 Boulogne Cedex
 Phone:(33) (146) 10-1700
 Fax:(33) (146) 10-1705



Germany

Hewlett-Packard GmbH
 Herrenberger Strasse 130
 71034 Böblingen
 Phone:(49) (180) 532-6222
 (49) (180) 525-8143
 Fax:(49) (180) 531-6122

Greece

Hewlett-Packard Hellas
 62, Kifissias Avenue
 GR-15125 Maroussi
 Phone: (30) (1) 689-6411
 Fax:(30) (1) 689-6508

Hungary

Hewlett-Packard Magyarország Kft.
 Erzsébet királyné útja 1/c.
 H-1146 Budapest
 Phone:(36) (1) 343-0550
 Fax:(36) (1) 122-3692
 Hardware Repair Center:
 Phone:(36) (1) 343-0312
 Customer Information Center:
 Phone:(36) (1) 343-0310

India

Hewlett-Packard India Ltd.
 Paharpur Business Centre
 21 Nehru Place
 New Delhi 110 019
 Phone:(91) (11) 647-2311
 Fax:(91) (11) 646-1117
 Hardware Repair Center and Extended
 Warranty Support:
 Phone:(91) (11) 642-5073
 (91) (11) 682-6042

Italy

Hewlett-Packard Italiana SpA
 Via Giuseppe di Vittorio, 9
 Cernusco Sul Naviglio
 I-20063 (Milano)
 Phone:(39) (2) 921-21
 Fax:(39) (2) 921-04473

Japan

Hewlett-Packard Japan, Ltd.
 3-29-21 Takaido-higashi
 Sugunami-ku, Tokyo 168
 Phone:(81) (3) 3335-8333



Fax:(81) (3) 3335-8338
 Hardware Repair Center:
 Phone:(81) (4) 7355-6660
 Fax:(81) (4) 7352-1848

Korea

Hewlett-Packard Korea
 25-12,
 Yoido-dong, Youngdeungpo-ku
 Seoul 150-010
 Phone:(82) (2) 769-0114
 Fax:(82) (2) 784-7084
 Hardware Repair Center:
 Phone:(82) (2) 3270-0700
 (82) (2) 707-2174 (DeskJet)
 (82) (2) 3270-0710 (Hardware)
 Extended Warranty Support:
 Phone:(82) (2) 3770-0365 (Bench)
 (82) (2) 769-0500 (Onsite)

Latin American Headquarters

5200 Blue Lagoon Drive Suite 950
 Miami, FL 33126,USA
 Phone:(1) (305) 267-4220

México

Hewlett-Packard de México, S.A. de C.V.
 Prolongación Reforma No. 700
 Lomas de Santa Fe
 01210 México, D.F.
 Phone:01-800-22147
 Outside Mexico City
 Phone:01 800-90529

Middle East/Africa

ISB HP Response Center
 Hewlett-Packard S.A.
 Rue de Veyrot 39
 P.O. Box 364
 CH-1217 Meyrin - Geneva
 Switzerland
 Phone:(41) (22) 780-4111

Netherlands

Hewlett-Packard Nederland
 BV Startbaan 16
 NL-1187 XR Amstelveen
 Postbox 667



NL-1180 AR Amstelveen
 Phone:(31) (020) 606-87-51
 Fax:(31) (020) 547-7755

New Zealand

Hewlett-Packard (NZ) Limited
 Ports of Auckland Building
 Princes Wharf, Quay Street
 P.O. Box 3860
 Auckland
 Phone:(64) (9) 356-6640
 Fax:(64) (9) 356-6620
 Hardware Repair Center and Extended
 Warranty Support:
 Phone:(64) (9) 0800-733547
 Customer Information Center:
 Phone:(64) (9) 0800-651651

Norway

Hewlett-Packard Norge A/S
 Postboks 60 Skøyen
 Drammensveien 169
 N-0212 Oslo
 Phone:(47) 2273-5600
 Fax:(47) 2273-5610

Poland

Hewlett-Packard Polska
 Al. Jerozolimskic 181
 02-222 Warszawa
 Phone:(48-22) 608-77-00
 Fax:(48-22) 608-76-00

Russia

AO Hewlett-Packard
 Business Complex Building #2
 129223, Moskva, Prospekt Mira VVC
 Phone:(7) (95) 928-6885
 Fax:(7) (95) 974-7829

Singapore

Hewlett-Packard Singapore
 (Sales) Pte Ltd
 450 Alexandra Road
 Singapore (119960)
 Phone: (65)275-3888
 Fax: (65)275-6839
 Hardware Repair
 Center and Customer
 Information Center:



Phone:(65) 272-5300
 Extended Warranty Support:
 Phone:(65) 272-5333

Spain

Hewlett-Packard Española, S.A.
 Carretera de la Coruña km 16.500
 E-28230 Las Rozas, Madrid
 Phone:(34) (1) 626-1600
 Fax:(34) (1) 626-1830

Sweden

Hewlett-Packard Sverige AB
 Skalholtsgatan 9
 S-164 97 Kista
 Phone:(46) (8) 444-2000
 Fax:(46) (8) 444-2666

Switzerland

Hewlett-Packard (Schweiz) AG
 In der Luberzen 29
 CH-8902 Urdorf/Zürich
 Phone:(41) (084) 880-11-11
 Fax:(41) (1) 753-7700

Taiwan

Hewlett-Packard Taiwan Ltd.
 8th Floor
 337, Fu-Hsing North Road
 Taipei, 10483
 Phone: (886)(02)717-0055
 FAX : (886)(02)514-0276
 Hardware Repair Center, call :
 North(886)(02) 717-9673
 Central(886)(04) 327-0153
 South(886)(080)733-733
 Extended Warranty Support Contact :
 Phone: (886)(02) 714-8882

Thailand

Hewlett-Packard (Thailand) Ltd.
 23-25/f Vibulthani Tower II
 2199 Rama 4 Rd, Klongton
 Klintoey, Bangkok 10110
 Thailand
 Phone:(66) (2) 666-3900-34
 Fax:(66) (2) 666-3935-37
 Hardware Repair Center and Extended
 Warranty Support Contact:
 Phone:(66) (2) 661-3900 ext. 6001/ 6002



Customer Information Center:
Phone:(66) (2) 661-3900 ext. 3211
Fax:(66) (2) 661-3943

Turkey

Hewlett-Packard Company
Bilgisayar Ve ölçüm Sistemleri AS
19 Mayıs Caddesi Nova
Baran Plaza Kat: 12
80220 Sisli-Istanbul
Phone:(90) (212) 224-5925
Fax:(90) (212) 224-5939

United Kingdom

Hewlett-Packard Ltd.
Cain Road
Bracknell
Berkshire RG12 1HN
Phone:(44) (134) 436-9222
Fax:(44) (134) 436-3344

Venezuela

Hewlett-Packard de Venezuela, S.A.
Los Ruices Norte
3A Transversal
Edificio Segre Caracas 1071
Phone:(58) (2) 239-4244
Fax:(58) (2) 239-3080



A Specifications



Overview

This appendix includes:

- [Paper Specifications](#)
- [Printer Specifications](#)



Paper Specifications

HP LaserJet printers produce excellent print quality. This printer accepts a variety of media, such as cut-sheet paper (including recycled paper), envelopes, labels, transparencies, and custom-size paper. Properties such as weight, grain, and moisture content are important factors affecting printer performance and output quality.

The printer can use a variety of paper and other print media in accordance with the guidelines in this manual. Paper that does not meet these guidelines may cause the following problems:

- poor print quality
- increased paper jams
- premature wear on the printer, requiring repair

Note

For best results, use only HP brand paper and print media. Hewlett-Packard Company cannot recommend the use of other brands. Because they are not HP products, HP cannot influence or control their quality.

It is possible for paper to meet all of the guidelines in this manual and still not produce satisfactory results. This might be the result of improper handling, unacceptable temperature and humidity levels, or other variables over which Hewlett-Packard has no control.

Before purchasing a large quantity of paper, make sure it meets the



requirements specified in this user guide and in the *HP LaserJet Printer Family Paper Specification Guide*. (To order the guide, see page [36](#).) Always test paper before purchasing a large quantity.



CAUTION

Using paper outside HP specifications may cause problems for the printer, requiring repair. This repair is not covered by the Hewlett-Packard warranty or service agreements.



Supported Sizes of Paper for Input and Output



Tray or Bin	Capacity	Paper	Weight
Tray 1 (multipurpose)	up to 100 sheets	<ul style="list-style-type: none"> Paper sizes: Letter, ISO A4, Executive, A5, Legal, 11 x 17, ISO A3, JIS B5, JIS B4, JPostD Custom sizes: Minimum: 3.67 x 7.5 in. (93 x 191 mm) Maximum: 11.7 x 17.7 in. (297 x 450 mm) <p>Note: You may print on both sides of paper that is equal to or larger than 5 by 7.5 in. (127 by 191 mm).</p> <ul style="list-style-type: none"> Other media types: transparencies, envelopes, and labels <p>Note: It is best to use Tray 1 when printing envelopes, transparencies, and labels.</p>	16 Bond to 53 lb Index (60 to 199 g/m ²) Two-sided: 16 to 20 lb Bond (60 to 105 g/m ²)

Tray or Bin	Capacity	Paper	Weight
Tray 2 and Optional 2 x 500-sheet Input Tray (Tray 4)	up to 500 sheets	Paper sizes: Letter, ISO A4, Legal, JIS B4	16 to 28 lb (60 to 105 g/m ²)
Tray 3 and Optional 2 x 500-sheet Input Tray (Tray 5)	up to 500 sheets	Paper sizes: Letter, ISO A4, Legal, JIS B4, ISO A3, 11 x 17	16 to 28 lb (60 to 105 g/m ²)
Optional 2000-sheet Input Tray (Tray 4)	up to 2000 sheets	Paper sizes: Letter, ISO A4, Legal, JIS B4, ISO A3, 11 x 17	16 to 28 lb (60 to 105 g/m ²)
Standard Output Bin (face-down)	up to 500 sheets	Paper sizes: Letter, ISO A4, A5, Executive, Legal, 11 x 17, ISO A3, JIS B5, JIS B4	
Left Output Bin (face-up)	up to 100 sheets	Paper sizes: Letter, ISO A4, A5, Executive, Legal, 11 x 17, ISO A3, JIS B5, JIS B4	



Paper Specifications

Tray or Bin	Capacity	Paper	Weight
5-bin Mailbox with Stapler and Multibin Mailbox (8 bins)	up to 250 sheets per bin	<p>Paper sizes: Letter, ISO A4, Legal, JIS B4, ISO A3, 11 x 17, envelopes, transparencies, labels</p> <p>Note: Envelopes, transparencies, and labels are only supported in the left output bin. The staple bin only supports A4, Legal, and Letter paper sizes.</p>	16 to 28 lb (60 to 105 g/m ²)
7-bin Tabletop Mailbox	up to 120 sheets per bin	<p>Paper sizes: Letter, ISO A4, Legal, 11 x 17, ISO A3, envelopes, transparencies, labels</p> <p>Note: Envelopes, transparencies, and labels are only supported in the left output bin.</p>	16 to 28 lb (60 to 105 g/m ²)
Envelope Feeder	up to 100 envelopes	Envelope sizes: Commercial #10, C5, DL, Monarch, ISO B5, JPostD	16 to 24 lb (60 to 90 g/m ²)
Duplexer		Paper sizes: Letter, Legal, 11 x 17, A3, A4, B4	16 to 28 lb (60 to 105 g/m ²)



Paper Specifications

Supported Types of Paper

The printer supports the following types of paper:

- plain
- letterhead
- prepunched
- bond
- color
- rough
- preprinted
- transparency
- labels
- recycled
- card stock
- user-defined (5 types)



Guidelines for Using Paper

For best results, use conventional 20 lb (75 g/m²) paper. Make sure the paper is of good quality, and free of cuts, nicks, tears, spots, loose particles, dust, wrinkles, voids, and curled or bent edges.

If you are unsure what type of paper you are loading (such as bond or recycled), check the label on the package of paper.

Some paper causes print quality problems, jamming, or damage to the printer.



Symptom	Problem with Paper	Solution
Poor print quality or toner adhesion. Problems with feeding.	Too moist, too rough, too smooth, or embossed; faulty paper lot.	Try another kind of paper, between 100-250 Sheffield, 4-6% moisture content.
Dropouts, jamming, curl.	Stored improperly.	Store paper flat in its moisture-proof wrapping.
Increased gray background shading.	Too heavy.	Use lighter paper. Open the left output bin.
Excessive curl. Problems with feeding.	Too moist, wrong grain direction or short-grain construction.	Open the left output bin. Use long-grain paper.



Symptom	Problem with Paper	Solution
Jamming, damage to printer.	Cutouts or perforations.	Do not use paper with cutouts or perforations.
Problems with feeding.	Ragged edges.	Use good quality paper.

Note Do not use letterhead paper that is printed with low-temperature inks, such as those used in some types of thermography.

Do not use raised letterhead.

The printer uses heat and pressure to fuse toner to the paper. Make sure that any colored paper or preprinted forms use inks that are compatible with the printer's temperature (392° F or 200° C for 0.1 second).



Paper Weight Equivalence Table

Use this table to determine approximate equivalent points in weight specifications other than U.S. bond weight. For example, to determine the equivalent of 20 lb U.S. bond weight paper in U.S. cover weight, locate the bond weight (in row 3, second column) and scan across the row to the cover weight (in the fourth column). The equivalent is 28 lb.

Shaded areas indicate a standard weight for that grade.



Paper Weight Equivalence

U.S. Post Card ^a thickness (mm)	U.S. Bond Weight (lb)	U.S. Text/ Book Weight (lb)	U.S. Cover Weight (lb)	U.S. Bristol Weight (lb)	U.S. Index Weight (lb)	U.S. Tag Weight (lb)	Europe Metric Weight (g/m ²)	Japan Metric Weight (g/m ²)
	16	41	22	27	33	37	60	60
	17	43	24	29	35	39	64	64
	20	50	28	34	42	46	75	75
	21	54	30	36	44	49	80	80



Paper Weight Equivalence (continued)

U.S. Post Card ^a thickness (mm)	U.S. Bond Weight (lb)	U.S. Text/ Book Weight (lb)	U.S. Cover Weight (lb)	U.S. Bristol Weight (lb)	U.S. Index Weight (lb)	U.S. Tag Weight (lb)	Europe Metric Weight (g/m ²)	Japan Metric Weight (g/m ²)
	22	56	31	38	46	51	81	81
	24	60	33	41	50	55	90	90
	27	68	37	45	55	61	100	100
	28	70	39	49	58	65	105	105
	32	80	44	55	67	74	120	120
	34	86	47	58	71	79	128	128
	36	90	50	62	75	83	135	135
.18	39	100	55	67	82	91	148	148
.19	42	107	58	72	87	97	157	157



Paper Weight Equivalence (continued)

U.S. Post Card ^a thickness (mm)	U.S. Bond Weight (lb)	U.S. Text/ Book Weight (lb)	U.S. Cover Weight (lb)	U.S. Bristol Weight (lb)	U.S. Index Weight (lb)	U.S. Tag Weight (lb)	Europe Metric Weight (g/m ²)	Japan Metric Weight (g/m ²)
.20	43	110	60	74	90	100	163	163
.23	47	119	65	80	97	108	176	176
	53	134	74	90	110	122	199	199

a. U.S. Post Card measurements are approximate. Use for reference only.



Labels

Note For best results, use Tray 1 and the Left Output Bin.

CAUTION To avoid damaging the printer, use only labels recommended for use in laser printers.

Never print on the same sheet of labels more than once.

Label Construction

When selecting labels, consider the quality of each component:

- **Adhesives:** The adhesive material should be stable at 392° F (200° C), the printer's maximum temperature.
- **Arrangement:** Only use labels with no exposed backing between them. Labels can peel off sheets with spaces between the labels, causing serious jams.
- **Curl:** Prior to printing, labels must lie flat with no more than 0.5 inch (13 millimeters) of curl in any direction.
- **Condition:** Do not use labels with wrinkles, bubbles, or other indications of separation.

To print sheets of labels, see page [115](#).



Transparencies

Note For best results, use Tray 1 and the Left Output Bin.

CAUTION Transparencies used in the printer must be able to withstand 392° F (200° C), the printer's maximum temperature. To avoid damaging the printer, use only transparencies recommended for use in laser printers.

If you have problems printing transparencies, use Tray 1.

To print transparencies, see page [117](#).



Envelopes

Note For best results, use the Left Output Bin.

Envelope Construction

Envelope construction is critical. Envelope fold lines can vary considerably, not only between manufacturers, but also within a box from the same manufacturer. Successful printing on envelopes depends upon the quality of the envelopes. When selecting envelopes, consider the following components:

- **Weight:** See page [258](#) for supported envelope weight.
- **Construction:** Prior to printing, envelopes should lie flat with less than 0.25 inch (6 mm) curl, and should not contain air. (Envelopes that trap air may cause problems.)
- **Condition:** Make sure envelopes are not wrinkled, nicked, or otherwise damaged.
- **Sizes in Tray 1:** See page [256](#) for supported paper sizes.
- **Sizes in the optional envelope feeder:** From 3.5 by 6.3 inches (90 by 160 millimeters) to 7 by 10 inches (178 by 254 millimeters).

Continued on next page.



If you do not have an optional envelope feeder, print envelopes from Tray 1, see page [111](#). To print envelopes with the optional envelope feeder, see page [107](#). If envelopes wrinkle, try opening the left output bin.



Envelopes with Double-Side-Seams

Double-side-seam construction has vertical seams at both ends of the envelope rather than diagonal seams. This style may be more likely to wrinkle. Be sure the seam extends all the way to the corner of the envelope as illustrated below.

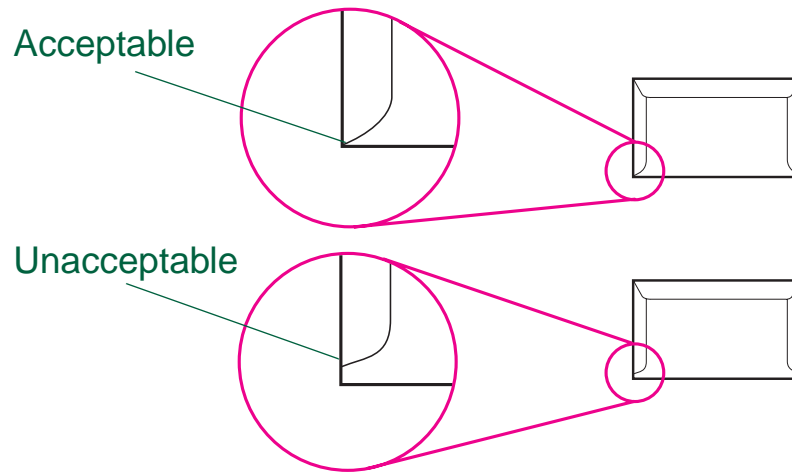

Envelopes with Adhesive Strips or Flaps

Envelopes with a peel-off adhesive strip or with more than one flap that folds over to seal must use adhesives compatible with the heat and pressure in the printer. The extra flaps and strips might cause wrinkling, creasing, or jams.



Envelope Margins

The following table gives typical address margins for a Commercial #10 or DL envelope.



Type of Address	Top Margin	Left Margin
Return Address	0.5 in (12.7 mm)	0.6 in (15.2 mm)
Delivery Address	2 in (51 mm)	4 in (85 mm)



Note

For the best print quality, position margins no closer than 0.6 inch (15 millimeters) from the edges of the envelope.

Envelope Storage

Proper storage of envelopes helps contribute to good print quality. Envelopes should be stored flat. If air is trapped in an envelope, creating an air bubble, then the envelope may wrinkle during printing.



Card Stock and Heavy Paper

Note For best results, use the Standard Output Bin.

Many types of card stock can be printed from Tray 1, including postcards. Some card stock performs better than others because its construction is better suited for feeding through a laser printer.

For optimum printer performance, do not use paper heavier than 53 lb (199 g/m²) in Tray 1 or 28 lb (105 g/m²) in other trays. Paper that is too heavy might cause misfeeds, stacking problems, paper jams, poor toner fusing, poor print quality, or excessive mechanical wear.

Note Printing on heavier paper may be possible if the tray is not filled to capacity, and paper with a smoothness rating of 100-180 Sheffield is used.



Card Stock Construction

- **Smoothness:** 36-53 lb (135-199 g/m²) card stock should have a smoothness rating of 100-180 Sheffield. 16-36 lb (60-135 g/m²) card stock should have a smoothness rating of 100-250 Sheffield.
- **Construction:** Card stock should lie flat with less than 0.2 inch (5 millimeters) of curl.
- **Condition:** Make sure card stock is not wrinkled, nicked, or otherwise damaged.
- **Sizes:** See page [256](#).



Note

Before loading card stock in Tray 1, make sure it is regular in shape and not damaged. Also, make sure the cards are not stuck together.

Card Stock Guidelines

- Set margins at least 0.08 inch (2 mm) away from the edges of the paper.



Printer Specifications

Physical Dimensions

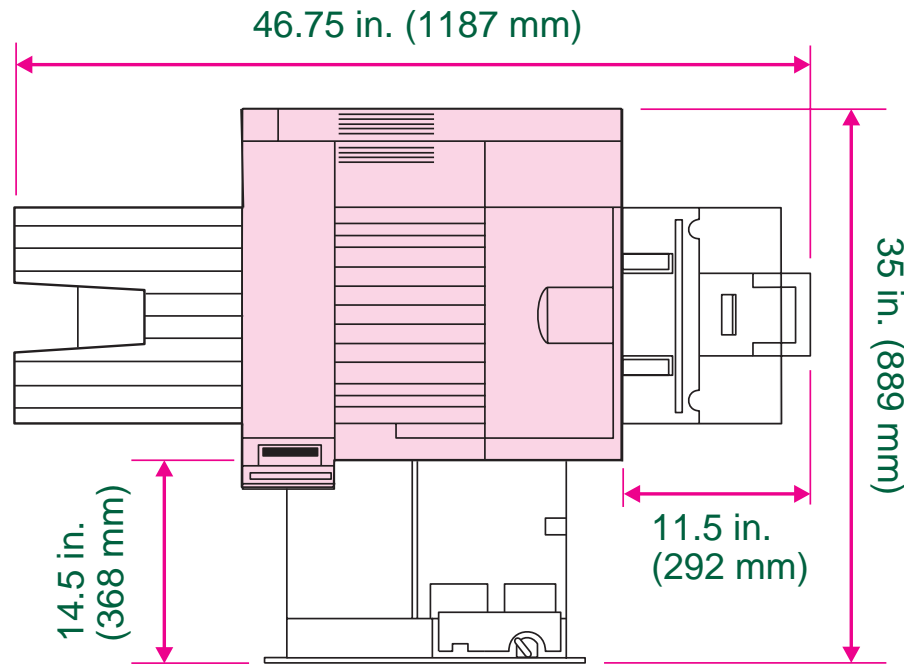

Continued on next page.



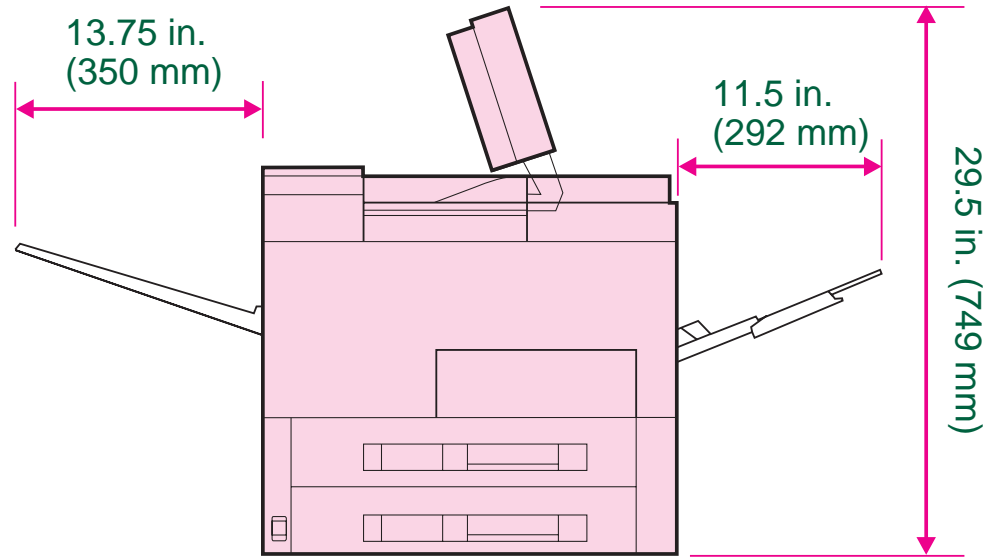

Continued on next page.



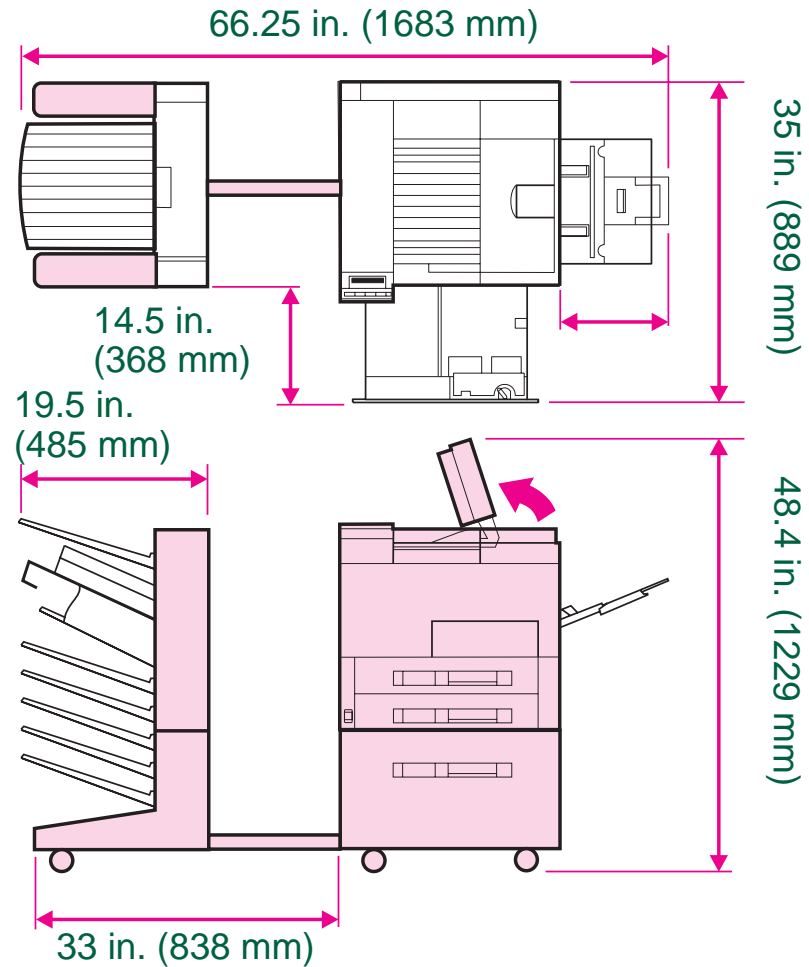

Printer Weight (without toner cartridge)

- HP LaserJet 8000 and 8000 N printers: 48 kg (106 lbs)
- HP LaserJet 8000 DN printer: 51 kg (113 lbs)



Environmental Specifications

Printer State	Power Consumption (average, in watts, base unit)	Power Consumption (average, in watts, fully configured unit)
Printing (100-127V units) (220-240V units)	500 Watts 505 Watts	550 Watts 530 Watts
Standby (100-127V units) (220-240V units)	135 Watts 140 Watts	145 Watts 150 Watts
Power Save (default activation time 60 minutes)	30 Watts 35 Watts	36 Watts (100-127V units) 41 Watts (220-240V units)
Off		0 Watts



Minimum Recommended Circuit Capacity

100-127 Volt	12.8 amps
220-240 Volt	5.8 amps



Printer Specifications



Power Requirements (Acceptable Line Voltage)

100-127 Volt (+/- 10%)	50-60 Hz (+/- 2 Hz)
220-240 Volt (+/- 10%)	50 Hz (+/- 2 Hz)
220 Volt (+/- 10%)	60 Hz (+/- 2 Hz)



Acoustic Emissions (Per ISO 9296)^a

	Operating (Printing) ^b	Power Save
Sound Power Level	6.6 Bel	5.3 Bel
Sound Pressure Level, L _{pAm} (Bystander Position)	51 dB	37 dB
Sound Pressure Level, L _{pAm} (Operator Position)	57 dB	42 dB



- a. Specifications are for the LaserJet 8000 (C4085A)
- b. Print speed is 24 ppm



General Specifications

Operating temperature	50-91° F (10-32.5° C)
Relative Humidity	20-80%
Speed, in pages per minute (ppm)	24 ppm
Expandable Memory	Up to 192 MB total, combining standard and accessory memory DIMMs.



Printer Specifications

B Control Panel Menus

Overview

You can perform most routine printing tasks from the computer through the printer driver or software application. This is the most convenient way to control the printer, and will override the printer's control panel settings. See the help files associated with the software, or for more information on accessing the printer driver, see page [52](#).

You can also control the printer by changing settings in the printer's control panel. Use the control panel to access printer features not supported by the printer driver or software application.

Note Printer driver and software commands override the printer's control panel settings.

You can print a menu map from the control panel that shows the **current** printer configuration (page [48](#)).

This appendix lists all the items and **possible** values for the printer. (Default values are listed in the "Item" column.)



Additional menu items can appear in the control panel, depending on the options currently installed in the printer.

See page [231](#) to print a control panel menu map.

This appendix includes:

- [Information Menu](#)
- [Paper Handling Menu](#)
- [Print Quality Menu](#)
- [Printing Menu](#)
- [Configuration Menu](#)
- [I/O Menu](#)
- [EIO Menu \(8000 N/8000 DN\)](#)
- [Resets Menu](#)



Information Menu

This menu contains printer information pages that give details about the printer and its configuration. To print an information page, scroll to the desired page and press **SELECT**.



Item	Explanation
PRINT MENU MAP	The menu map shows the layout and current settings of the control panel menu items. For more information, see page 231 .
PRINT CONFIGURATION	The configuration page shows the printer's current configuration. If an HP JetDirect print server card is installed (HP LaserJet 8000 N and 8000 DN printers), a JetDirect configuration page will print out as well. For more information, see page 228 .
PRINT PCL FONT LIST	The PCL font list shows all the PCL fonts currently available to the printer. For more information, see page 232 .
PRINT PS FONT LIST	The PS font list shows all the PS fonts currently available to the printer. For more information, see page 232 .



Item	Explanation
PRINT FILE DIRECTORY	This item appears only when a mass storage device (such as an optional flash DIMM or hard disk) containing a recognized file system is installed in the printer. The file directory shows information for all installed mass storage devices. For more information, see page 234 .
PRINT EVENT LOG	The event log lists printer events or errors.
SHOW EVENT LOG	This item allows you to view the most recent printer events on the control panel display. Press - VALUE + to scroll through the event log entries.
PRINT PAPER PATH TEST	The paper path test can be used to verify that the paper path is working properly, or to troubleshoot problems with a type of paper. Choose the input tray, output bin, duplexer (if available), and number of copies.



Paper Handling Menu

When paper handling settings are correctly configured through the control panel, you can print by choosing the type and size of paper from the printer driver or software application. For more information, see page [134](#).

Some items in this menu (such as duplex and manual feed) can be accessed from a software application, or from the printer driver (if the appropriate driver is installed). Printer driver and software application settings override control panel settings. For more information, see page [125](#).



Item	Values	Explanation
ENVELOPE FEEDER SIZE=COM10	For supported paper sizes, see page 256 .	This item appears only when the optional envelope feeder is installed. Set the value to correspond with the envelope size currently loaded in the envelope feeder. Note The default indicated here is for 110V printers. The default envelope size for 220V printers is DL.
ENVELOPE FEEDER TYPE=PLAIN	For supported paper types, see page 256 .	This item appears only when the optional envelope feeder is installed. Set the value to correspond with the envelope type currently loaded in the envelope feeder.



Item	Values	Explanation
TRAY 1 MODE= FIRST	FIRST CASSETTE	Determine how the printer will use Tray 1. FIRST: If paper is loaded in Tray 1, the printer will pull paper from that tray first. CASSETTE: A paper size must be assigned to Tray 1 using the TRAY 1 SIZE option (the next item in this menu when TRAY 1 MODE=CASSETTE). This allows Tray 1 to be used as a reserved tray. For more information, see page 131 .
TRAY 1 SIZE= LETTER	For supported paper sizes, see page 256 .	This item appears only when TRAY 1 MODE= CASSETTE. Set the value to correspond with the paper size currently loaded in Tray 1.
TRAY 1 TYPE= PLAIN	For supported paper types, see page 256 .	This item appears only when TRAY 1 MODE= CASSETTE. Set the value to correspond with the paper type currently loaded in Tray 1.
TRAY 2 TYPE= PLAIN	For supported paper types, see page 256 .	Set the value to correspond with the paper type currently loaded in Tray 2.
TRAY 3 TYPE= PLAIN	For supported paper types, see page 256 .	Set the value to correspond with the paper type currently loaded in Tray 3.



Paper Handling Menu

Item	Values	Explanation
TRAY 4 TYPE= PLAIN	For supported paper types, see page 256 .	This item appears only when a fourth paper tray is installed. Set the value to correspond with the paper type currently loaded in Tray 4.
TRAY 5 TYPE= PLAIN	For supported paper types, see page 256 .	This item appears only when a fifth paper tray is installed. Set the value to correspond with the paper type currently loaded in Tray 5.
PAPER DEST= STANDARD OUTBIN	STANDARD OUTBIN LEFT OUTBIN OPTIONAL BIN	This item appears only when a mailbox is installed. Set the value to correspond with the appropriate bin.
MANUAL FEED=OFF	OFF ON	Feed the paper manually from Tray 1, rather than automatically from a tray. When MANUAL FEED=ON and Tray 1 is empty, the printer goes offline when it receives a print job and displays MANUALLY FEED [PAPER SIZE]. For more information, see page 133 .



Item	Values	Explanation
DUPLEX=OFF	OFF ON	This item appears only when an optional duplexer is installed. Set the value to ON to print on both sides (duplex) or OFF to print on one side (simplex) of a sheet of paper. For more information, see page 102 .
BINDING= LONG EDGE	LONG EDGE SHORT EDGE	This item appears only when an optional duplexer is installed and the duplex option is on. Choose the binding edge when duplexing (printing on both sides of paper). For more information, see page 102 .
OVERRIDE A4/LETTER=NO	NO YES	Choose YES to print on letter size paper when an A4 job is sent, but no A4 size paper is loaded in the printer (or to print on A4 size paper when a letter job is sent, but no letter paper is loaded in the printer).



Print Quality Menu

Some items in this menu can be accessed from a software application, or from the printer driver (if the appropriate driver is installed). Printer driver and software application settings override control panel settings. For more information, see page [125](#).



Item	Values	Explanation
RESOLUTION=	300	Select the resolution from the following values: 300: Produces draft print quality at the printer's maximum speed (24 ppm). 300 dpi (dots per inch) is recommended for some bitmapped fonts and graphics, and for compatibility with the HP LaserJet III family of printers. 600: Produces high print quality at the printer's maximum speed (24 ppm). FASTRES 1200: Produces optimum print quality (comparable to 1200 dpi) at the printer's maximum speed (24 ppm). Note It is best to change the resolution from the printer driver or software application. (Driver and software settings override control panel settings.)
FASTRES 1200	600	
	FASTRES 1200	

Item	Values	Explanation
RET=MEDIUM	OFF LIGHT MEDIUM DARK	<p>Use the printer's Resolution Enhancement technology (REt) setting to produce print with smooth angles, curves, and edges.</p> <p>All print resolutions, including FastRes 1200, benefit from REt.</p> <p>Note It is best to change the REt setting from the printer driver or software application. (Driver and software settings override control panel settings.)</p>
ECONOMODE=OFF	OFF ON	<p>Turn EconoMode on (to save toner) or off (for high quality). EconoMode creates draft-quality printing by reducing the amount of toner on the printed page by up to 50%.</p> <p>CAUTION HP does not recommend full-time use of EconoMode. (If EconoMode is used full-time, it is possible that the toner supply will outlast the mechanical parts in the toner cartridge.)</p> <p>Note It is best to turn EconoMode on or off from the printer driver or software application. (Driver and software settings override control panel settings.)</p>



Item	Values	Explanation
TONER DENSITY=3	1 2 3 4 5	<p>Lighten or darken the print on the page by changing the toner density setting. The settings range from 1 (light) to 5 (dark), but the default setting of 3 usually produces the best results.</p> <p>Use a lower toner density setting to save toner.</p> <p>Note It is best to change the toner density from the printer driver or software application. (Driver and software settings override control panel settings.)</p>
CREATE CLEANING PAGE	No value to select.	<p>Press SELECT to print a cleaning page (for cleaning excess toner from the paper path).</p> <p>In order for the cleaning page to work properly, print the page on copier grade paper (not bond or rough paper). Follow the instructions on the cleaning page.</p>
PROCESS CLEANING PAGE	No value to select.	<p>This item appears only after a cleaning page has been generated (as described above).</p> <p>Press SELECT to process the cleaning page.</p>



Printing Menu

Some items in this menu can be accessed from a software application, or from the printer driver (if the appropriate driver is installed). Printer driver and software application settings override control panel settings. For more information, see page [125](#).

Item	Values	Explanation
COPIES=1	1 to 999	Set the default number of copies by selecting any number from 1 to 999. Press -VALUE + once to change the setting by increments of 1, or hold down -VALUE + to scroll by increments of 10. Note It is best to set the number of copies from the printer driver or software application. (Driver and software settings override control panel settings.)
PAPER= LETTER (110V printers) and ENVELOPE= COM10 (110V printers)	For supported paper sizes, see page 256 .	Set the default image size for paper and envelopes. (The item name will change from paper to envelope as you scroll through the available sizes.) Note The defaults indicated here are for 110V printers. The default paper size for 220V printers is A4. The default envelope size for 220V printers is DL.
CONFIGURE CUSTOM PAPER=NO	NO YES	NO: The custom paper menu items are not accessible. YES: The custom paper menu items appear (see below).



Item	Values	Explanation
UNIT OF MEASURE=INCHES (110V printers) or MILLIMETERS (220V printers)	INCHES MILLIMETERS	This item appears only when CONFIGURE CUSTOM PAPER=YES. Select the unit of measurement for the custom paper size.
X DIMENSION= 11.7 INCHES (110V printers) or 297 MILLIMETERS (220V printers)	For supported paper sizes, see page 256 .	This item appears only when CONFIGURE CUSTOM PAPER=YES. Select the dimension to be fed into the printer (short edge).
Y DIMENSION= 17.7 INCHES (110V printers) or 450 MILLIMETERS (220V printers)	For supported paper sizes, see page 256 .	This item appears only when CONFIGURE CUSTOM PAPER=YES. Select the other dimension (long edge).



Item	Values	Explanation
ORIENTATION= PORTRAIT	PORTRAIT LANDSCAPE	Determine the default orientation of print on the page. Note It is best to set the page orientation from the printer driver or software application. (Driver and software settings override control panel settings.)
FORM=60 LINES (110V printers) or 64 LINES (220V printers)	5 to 128	Sets vertical spacing from 5 to 128 lines for default paper size. Press -VALUE + once to change the setting by increments of 1, or hold down -VALUE + to scroll by increments of 10.
PCL FONT SOURCE=INTERNAL	INTERNAL SOFT SLOT 1, 2, or 3	INTERNAL: Internal fonts. SOFT: Permanent soft fonts. SLOT 1, 2, or 3: Fonts stored in one of the three DIMM slots.
PCL FONT NUMBER= 0 to 999 0		The printer assigns a number to each font and lists them on the PCL Font List (page 232). The font number appears in the Font # column of the printout.



Item	Values	Explanation
PCL FONT PITCH= 10.00	0.44 to 99.99	This item might not appear, depending on the font selected. Press -VALUE + once to change setting by increments of .01 for pitch, or hold down -VALUE + to scroll by increments of 1.
PCL FONT POINT SIZE=12.00	4.00 to 999.75	This item might not appear, depending on the font selected. Press -VALUE + once to change setting by increments of .25 for point size, or hold down -VALUE + to scroll by increments of 1.
PCL SYMBOL SET=PC-8	PC-8 many others	Select any one of several available symbol sets from the printer's control panel. A symbol set is a unique grouping of all the characters in a font. PC-8 or PC-850 is recommended for line draw characters.
COURIER=REGULAR	REGULAR DARK	Select the version of Courier font to use: REGULAR: The internal Courier font available on the HP LaserJet 4 series printers. DARK: The internal Courier font available on the HP LaserJet III series printers. Both fonts are not available at the same time.



Item	Values	Explanation
WIDE A4=NO YES	NO YES	The Wide A4 setting changes the number of characters that can be printed on a single line of A4 paper. NO: Up to 78 10-pitch characters can be printed on one line. YES: Up to 80 10-pitch characters can be printed on one line.
APPEND CR TO LF= NO	NO YES	Select YES to append a carriage return to each line feed encountered in backward-compatible PCL jobs (pure text, no job control). Some environments, such as UNIX, indicate a new line using only the line feed control code. This option allows the user to append the required carriage return to each line feed.
PRINT PS ERRORS=OFF	OFF ON	Select ON to print the PS error page when PS errors occur.



Configuration Menu

Items in this menu affect the printer's behavior. Configure the printer according to your printing needs.



Item	Values	Explanation
POWERSAVE= 1 HOUR	OFF 15 MINUTES 30 MINUTES 1 HOUR 2 HOURS 3 HOURS	<p>Set the printer to enter Power Save after it has been idle for a specified amount of time. Turning Power Save off is not recommended. The Power Save feature does the following:</p> <p>Minimizes the amount of power consumed by the printer when it is idle.</p> <p>Reduces wear on the printer's electronic components. (Turns off the display's backlight.)</p> <p>When you send a print job, press a control panel key, open a paper tray, or open the top cover, the printer automatically comes out of Power Save mode.</p> <p>Note Power Save turns off the backlight on the display, but the display is still readable.</p>



Item	Values	Explanation
PERSONALITY= AUTO	AUTO PCL PS	<p>Select the default printer language (personality). Possible values are determined by which valid languages are installed in the printer.</p> <p>Normally you should not change the printer language (the default is <code>AUTO</code>). If you change it to a specific printer language, the printer will not automatically switch from one language to another unless specific software commands are sent to the printer.</p>



Item	Values	Explanation
RESOURCE SAVE= OFF ON AUTO		<p>This item dedicates printer memory to save each language’s permanent resources. (You might need to add memory to the printer in order for this item to appear.) The amount of memory set aside can be different for each installed language. Some languages might have memory set aside for resource saving without requiring all languages to do so. Any time the amount of memory dedicated to a specific language is changed, all languages will lose all saved resources, including any unprocessed print jobs.</p> <p>OFF: No language resource saving is performed, and language-dependent resources, such as fonts and macros, are lost when language or resolution changes.</p> <p>ON: An item will appear for each installed language that allows the user to allocate a particular amount of memory to that language’s resource saving area. (See the items below.)</p> <p>AUTO: The printer automatically determines the amount of memory to use for each installed language’s resource saving area.</p> <p>For more information, see page 316.</p>



Item	Values	Explanation
PCL MEMORY= 400K	0K and up (This value depends on the amount of installed memory.)	This item appears only when RESOURCE SAVE=ON. Select the amount of memory used for saving PCL resources. Printer default is the minimum amount of memory needed to perform resource saving for PCL. Press -VALUE+ to change settings by increments of 10 (up to 100 KB) or by increments of 100 (above 100 KB). For more information, see page 316 .
PS MEMORY= 400K	0K and up (This value depends on the amount of installed memory.)	This item appears only when RESOURCE SAVE=ON. Select the amount of memory used for saving PS resources. Printer default is the minimum amount of memory needed to perform resource saving for PS. Press -VALUE+ to change settings by increments of 10 (up to 100 KB) or by increments of 100 (above 100 KB). For more information, see page 316 .
PAGE PROTECT= AUTO	AUTO ON	This item appears only after a 21 PAGE TOO COMPLEX; PRESS GO TO CONTINUE message displays (page 178). Memory Enhancement technology (MEt) attempts to guarantee that all pages will print. If the page does not print, turn PAGE PROTECT to ON. This might increase chances of a 20 INSUFFICIENT MEMORY; PRESS GO TO CONTINUE message. If this occurs, simplify the print job or install additional memory (page 310).





Item	Values	Explanation
CLEARABLE WARNINGS=JOB	JOB ON	Set the amount of time that a clearable warning is displayed on the printer's control panel. JOB: Warning messages display on the control panel until the end of the job from which they were generated. ON: Warning messages display on the control panel until Go is pressed.
AUTO CONTINUE= ON ON	OFF	This item determines how the printer reacts to errors. ON: If an error occurs that prevents printing, the message will display, and the printer will go offline for 10 seconds before returning online. OFF: If an error occurs that prevents printing, the message will remain on the display and the printer will remain offline until Go is pressed.
TONER LOW=CONTINUE	CONTINUE STOP	This item determines how the printer behaves when toner is low. The TONER LOW message will first appear when the toner cartridge is almost out of toner. (About 100 to 300 sheets can still be printed.) CONTINUE: The printer will continue to print while the TONER LOW message is displayed. STOP: The printer will go offline and wait for further action. For more information, see page 137 .

Item	Values	Explanation
RAM DISK=OFF	OFF ON AUTO	<p>This item determines how the RAM disk is configured. This item appears only if there is no optional hard disk installed and the printer has at least 12 MB of memory.</p> <p>OFF: The RAM disk is disabled.</p> <p>ON: The RAM disk is enabled. Configure the amount of memory to be used through the following item: RAM DISK SIZE.</p> <p>Note If the setting is changed from OFF to ON or from OFF to AUTO, the printer will automatically reinitialize when it becomes idle.</p>
RAM DISK SIZE=xxxK	0K and up (This value depends on the amount of installed memory.)	<p>This item determines the size of the RAM disk. This item appears if RAM DISK=ON or AUTO.</p> <p>Press - VALUE + to change settings by increments of 100.</p> <p>Note This setting cannot be changed if RAM DISK=AUTO. Changing this value will cause the printer to reinitialize when it becomes idle.</p>



Item	Values	Explanation
JAM RECOVERY= AUTO	AUTO ON OFF	This item determines how the printer behaves when a paper jam occurs. AUTO: The printer automatically selects the best mode for printer jam recovery (usually ON). This is the default setting. ON: The printer automatically reprints pages after a paper jam is cleared. OFF: The printer does not reprint pages following a paper jam. Printing performance might be increased with this setting.



MAINTENANCE MESSAGE=OFF	OFF	This item appears only after the PERFORM PRINTER MAINTENANCE message displays. OFF: The PERFORM PRINTER MAINTENANCE message will be cleared and will not be displayed again until the next maintenance is due. The message should not be turned off unless the printer maintenance has been performed. If the required maintenance is not performed, the printer's performance will degrade.
----------------------------	-----	--



I/O Menu

Items in the I/O (input/output) Menu affect the communication between the printer and the computer.



Item	Values	Explanation
I/O TIMEOUT=15	5 to 300	<p>Select the I/O timeout period in seconds. (I/O timeout refers to the time, measured in seconds, that the printer waits before ending a print job.)</p> <p>This setting allows you to adjust timeout for best performance. If data from other ports appear in the middle of your print job, increase the timeout value.</p> <p>Press - VALUE + once to change settings by increments of 1, or hold down - VALUE + to scroll by increments of 10.</p>



Item	Values	Explanation
I/O BUFFER=	AUTO ON OFF	<p>Allocate memory for I/O buffering.</p> <p>AUTO: The printer automatically reserves memory for I/O buffering. Additional configurations are not required and the I/O BUFFER SIZE menu item does not appear.</p> <p>ON: The I/O BUFFER SIZE item appears (see below). Specify the amount of memory to be used for I/O buffering.</p> <p>OFF: I/O buffering is not performed and the I/O BUFFER SIZE item does not appear.</p> <p>When the I/O buffer setting is changed, any downloaded resources (such as fonts or macros) will need to be downloaded again, unless they are stored on an optional hard disk or flash DIMM.</p> <p>For more information, see page 318.</p>
I/O BUFFER SIZE= 100K	10K and up	<p>This item appears only when I/O BUFFER=ON. Specify the amount of memory for I/O buffering. The maximum amount of memory available for I/O buffering is determined by the amount of memory installed in the printer, the languages installed in the printer, and by other memory allocations that must be made.</p> <p>Press - VALUE + to change settings by increments of 10 (up to 100 KB) or by increments of 100 (above 100 KB).</p>



Item	Values	Explanation
PARALLEL HIGH SPEED=YES	YES NO	Select the speed at which data is transmitted to the printer. YES: The printer accepts faster parallel communications used for connections with newer computers. NO: The printer accepts slower parallel communications used for connections with older computers.
PARALLEL ADV FUNCTIONS=ON	ON OFF	Turn the bidirectional parallel communication on or off. The default is set for a bidirectional parallel port (IEEE-1284). This setting allows the printer to send status readback messages to the computer. (Turning the parallel advanced functions on might slow language switching.)



EIO Menu (8000 N/8000 DN)

EIO (enhanced input/output) Menus depend on the particular accessory product installed in an EIO slot of the printer. If the printer contains an HP JetDirect print server EIO card, you can configure basic networking parameters using the EIO Menu. These and other parameters can also be configured through HP JetAdmin.



Item	Values	Explanation
CFG NETWORK=NO	NO YES	NO: The JetDirect Menu is not accessible. YES: The JetDirect Menu appears.
NOVELL=ON	ON OFF	Select whether the IPX/SPX protocol stack (in Novell NetWare networks, for example) is enabled (on) or disabled (off).
DLC/LLC=ON	ON OFF	Select whether the DLC/LLC protocol stack is enabled (on) or disabled (off).
TCP/IP=ON	ON OFF	Select whether the TCP/IP protocol stack is enabled (on) or disabled (off).



Item	Values	Explanation
ETALK=ON	ON OFF	Select whether the Apple EtherTalk protocol stack is enabled (on) or disabled (off).
CFG NOVELL=NO	NO YES	<p>NO: The IPX/SPX Menu is not accessible.</p> <p>YES: The IPX/SPX Menu appears. In the IPX/SPX Menu, you can specify the frame type parameter used on your network. The default is AUTO, to automatically set and limit the frame type to the one detected.</p> <p>For Ethernet cards, frame type selections include ENL8023, ENLII, ENL8022, ENLSNAP.</p> <p>For Token Ring cards, frame type selections include TR_8022, TR_SNAP.</p> <p>In the IPX/SPX Menu for Token Ring cards, you can also specify NetWare Source Routing parameters, which include SRC RT=AUTO (default), OFF, SINGLE R, or ALL RT.</p>



Item	Values	Explanation
CFG TCP/IP=NO	NO YES	NO: The TCP/IP Menu is not accessible. YES: The TCP/IP Menu appears. In the TCP/IP Menu, you can specify BOOTP=YES for TCP/IP parameters to be automatically loaded from a bootp or DHCP server when the printer is turned on. If you specify BOOTP=NO, you can manually set selected TCP/IP parameters from the control panel. You can manually set each byte of the IP address (IP), Subnet Mask (SM), Syslog Server (LG), and Default Gateway (GW). Also, you can manually set the Timeout time period.
CFG ETALK=NO	NO YES	NO: The EtherTalk Menu is not accessible. YES: The EtherTalk Menu appears. In the EtherTalk Menu you can set the AppleTalk phase parameter (ETALK PHASE=1 or 2) for your network.



Resets Menu

Use this menu with caution. You can lose buffered page data or printer configuration settings when you select these items. Only reset the printer under the following circumstances:

- You want to restore the printer's default settings.
- Communication between the printer and computer has been interrupted.
- You are having problems with a port.

The items in the Resets Menu will clear all memory in the printer, while **CANCEL JOB** clears only the current job.



Item	Explanation
RESET MEMORY	This item clears the printer buffer and the active I/O input buffer, and makes the control panel defaults current. Resetting memory during a print job can result in data loss.
RESTORE FACTORY SETTINGS	This item performs a simple reset and restores most of the factory (default) settings. This item also clears the input buffer for the active I/O. Resetting memory during a print job can result in data loss.

Item	Explanation
RESET ACTIVE I/O CHANNEL	This item performs a simple reset and clears the input and output buffers (for the active I/Os only). Resetting memory during a print job can result in data loss.
RESET ALL I/O CHANNELS	This item performs a simple reset and clears the input and output buffers for all I/Os.



C Printer Memory and Expansion



Overview

The printer has three dual in-line memory module (DIMM) slots for upgrading with:

- More printer memory. DIMMs are available in 4, 8, 16, 32, and 64 MB, for a maximum of 192 MB.
- Flash memory DIMMs, available in 2 and 4 MB. Unlike standard printer memory, flash DIMMs can be used to permanently store downloaded items in the printer, even when the printer is off.
- DIMM-based accessory fonts, macros, and patterns.

Continued on next page.



- Other DIMM-based printer languages and printer options.



Note Single in-line memory modules (SIMMs) used on previous HP LaserJet printers are not compatible with this printer.

You might want to add more memory to the printer if you often print complex graphics or PS documents, print with the optional duplexer, use many downloaded fonts, and print large paper sizes (such as A3, B4, or 11 x 17).



The printer has three enhanced input/output (EIO) slots for expanding the printer's capabilities with:



- A network card.
- A mass storage device, such as a hard disk.

For ordering information, see page [39](#).



To find out how much memory is installed in the printer, or to find out what is installed in the EIO slots, print a configuration page (page [228](#)).



This appendix includes:

- [Installing Memory](#)
- [Checking Memory Installation](#)
- [Adjusting Memory Settings](#)
- [Installing EIO Cards/Mass Storage](#)



Installing Memory

CAUTION

Static electricity can damage dual in-line memory modules (DIMMs). When handling DIMMs, either wear an antistatic wrist strap or frequently touch the surface of the DIMM's antistatic package, then touch bare metal on the printer.

If you have not already done so, print a configuration page to find out how much memory is installed in the printer before adding more memory (page [228](#)).

- 1 Turn the printer off. Unplug the power cord and disconnect any cables.
- 2 Loosen the two captive thumb screws on the back of the printer.

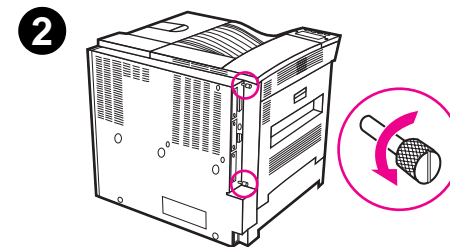
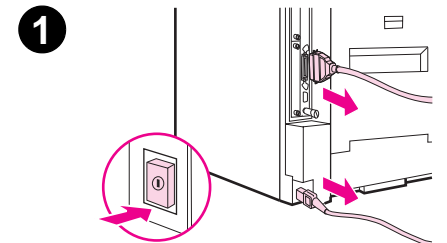

- 3 Grasp the screws and pull the formatter board out of the printer. Place it on a flat, non-conductive surface.
- 4 Remove the DIMM from the antistatic package. Hold the DIMM with fingers against the side edges and thumbs against the back edge. Align the notches on the DIMM with the DIMM slot. (Check that the locks on each side of the DIMM slot are open, or outward.)
- 5 Press the DIMM straight into the slot (press firmly). Make sure the locks on each side of the DIMM snap inward into place. (To remove a DIMM, the locks must be released.)

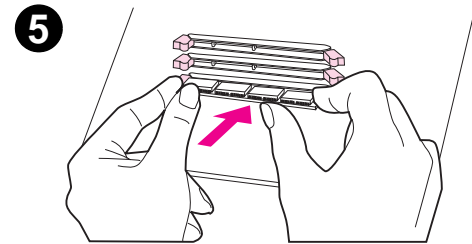
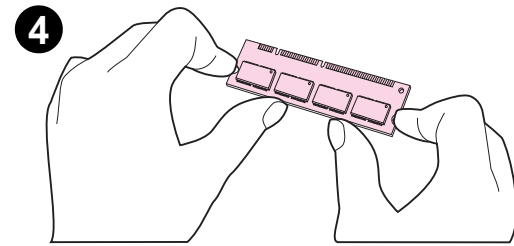
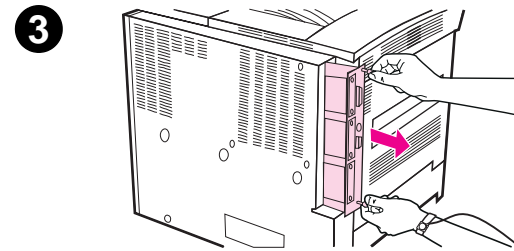

- 6 Slide the formatter board back into the printer and tighten the two screws.
- 7 Plug in the power cord and connect all cables. Turn the printer on.

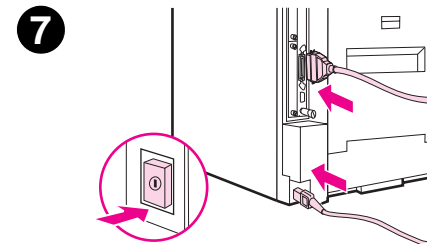
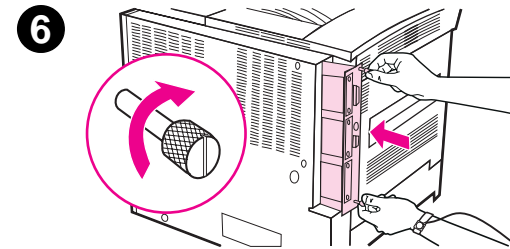

Checking Memory Installation

Follow this procedure to verify that DIMMs are installed correctly:

1. Check that the printer's control panel displays `READY` when the printer is turned on. If an error message appears, a DIMM might have been incorrectly installed. Check the printer messages (page [228](#)).
2. Print a new configuration page (page [228](#)).
3. Check the memory section on the configuration page and compare it to the configuration page printed before the DIMM installation. If the amount of memory has not increased, the DIMM might not be installed correctly (repeat the installation procedure) or the DIMM might be defective (try a new DIMM, or try installing the DIMM in a different slot).

Note

If you installed a printer language (personality), check the Installed Personalities and Options section on the configuration page. This area should list the new printer language.



Adjusting Memory Settings

Resource Saving

Resource Saving allows the printer to keep downloaded resources (permanent downloaded fonts, macros, or patterns) in memory when the printer language or resolution is changed.

If you do not have an optional hard disk or flash DIMM for storing downloaded resources, you might want to change the amount of memory allocated to each language when downloading an unusually large number of fonts, or if the printer is in a shared environment.

The minimum amount of memory that can be allocated to Resource Saving is 400 KB each for PCL and PS.

To determine how much memory to allocate to a language:

1. From the Configuration Menu, set `RESOURCE SAVE=ON` (page [228](#)). You might need to add memory to the printer in order for this option to appear in the printer's control panel.
2. Also from the Configuration Menu, choose either `PCL MEMORY` or `PS MEMORY` and change the setting to the highest value displayed. This amount will vary depending upon how much memory is installed in the printer.

Continued on next page.



3. Using a software application, download all the fonts you want to use in the selected language.
4. Print a configuration page (page [228](#)). The amount of memory used by the fonts is listed next to the language. Round this figure up to the nearest 100 KB. (For example, if 475 KB are shown, 500 KB should be reserved.)
5. From the Configuration Menu, set PCL MEMORY or PS MEMORY to the value determined in step 4.
6. Repeat step 3. (You must download all fonts again. See the note below.)



Note

When you change the Resource Saving setting, all downloaded resources (such as fonts or macros) will need to be downloaded again, unless they are stored on an optional hard disk or flash DIMM.



I/O Buffering

To allow the computer to continue working without waiting for the print job to finish queuing, the printer uses a portion of its memory (an I/O buffer) to hold jobs in progress. (If I/O buffering is off, no memory is reserved for this function.)

In most cases, it is best to let the printer automatically reserve memory for I/O buffering.

To speed network printing, you might want to increase the amount of memory reserved for I/O buffering.

To change the I/O Buffer setting:

1. From the I/O Menu, set I/O BUFFER=ON (page [302](#)).
2. Also from the I/O Menu, set I/O SIZE to the desired value.

Note

When you change the I/O Buffer setting, all downloaded resources (such as fonts or macros) will need to be downloaded again, unless they are stored on an optional hard disk or flash DIMM.



Decreasing Page Processing Time

The Run Location Menu Item in the Configuration Menu allows you to increase the speed at which printer instructions can be moved from memory to the processor. See “[Configuration Menu](#)” on page [295](#) for more information.



Installing EIO Cards/Mass Storage

Turn off the printer before installing the EIO cards or mass storage device.

See the graphic below for orientation and location of the EIO cards or optional mass storage device, such as a hard disk.

Use HP JetAdmin to delete files from a mass storage device (page [72](#)). Use HP FontSmart to manage fonts on a mass storage device (page [67](#)). For more information, see the printer software help.

HP is constantly introducing new software tools for use with your printer and accessories. These tools are available from the Internet free of charge. See page [3](#) for how to visit the HP website for more information.

After you have installed a new device, print a configuration page.

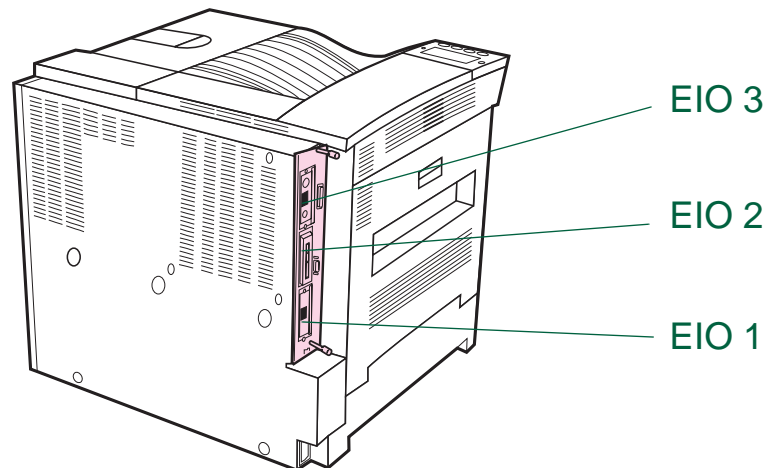

D Printer Commands



Overview

Most software applications do not require you to enter printer commands. See your computer and software documentation to find the method for entering printer commands, if needed.

PCL PCL printer commands tell the printer which tasks to perform or which fonts to use. This appendix provides a quick reference for users who are already familiar with PCL command structure.

Note: The PCL 5e printer driver in this printer is not backward compatible with older printers that use PCL 5e printer drivers.

Unless PCL 5e backward compatibility is required, HP recommends that PCL 6 printer drivers be used to take full advantage of all printer features.



HP-GL/2 The printer has the ability to print vector graphics using the HP-GL/2 graphics language. Printing in the HP-GL/2 language requires that the printer leave PCL language and enter HP-GL/2 mode, which can be done by sending the printer PCL code. Some software applications switch languages through their drivers.

PJL HP's Printer Job Language (PJL) provides control above PCL and other printer languages. The four major functions provided by PJL are: printer language switching, job separation, printer configuration, and status readback from the printer. PJL commands may be used to change printer default settings.

This appendix includes:

- [Understanding PCL Printer Command Syntax](#)
- [Selecting PCL Fonts](#)
- [Common PCL Printer Commands](#)

Note

The table at the end of this appendix contains commonly used PCL 5e commands (page [327](#)). For a complete listing and explanation of how to use PCL, HP-GL/2, and PJL commands, order the *PCL 5/PJL Technical Reference Documentation Package* (page [36](#)).

To receive more information about printer commands via fax, call HP FIRST (Fax Information Retrieval Service Technology) and request an index for HP LaserJet printers. (See the [HP Support](#) pages at the front of this user guide.)



Understanding PCL Printer Command Syntax

Before using printer commands, compare these characters:

Lowercase l:	<i>l</i>	Uppercase O:	O
Number one:	1	Number 0:	Ø

Many printer commands use the lowercase letter l (*l*) and the number one (1), or the uppercase letter O (O) and the number zero (Ø). These characters may not appear on your screen as shown here. You must use the exact character and case specified for PCL printer commands.

Escape character
(begins escape sequence)

Value field (contains both
alpha and numeric characters)

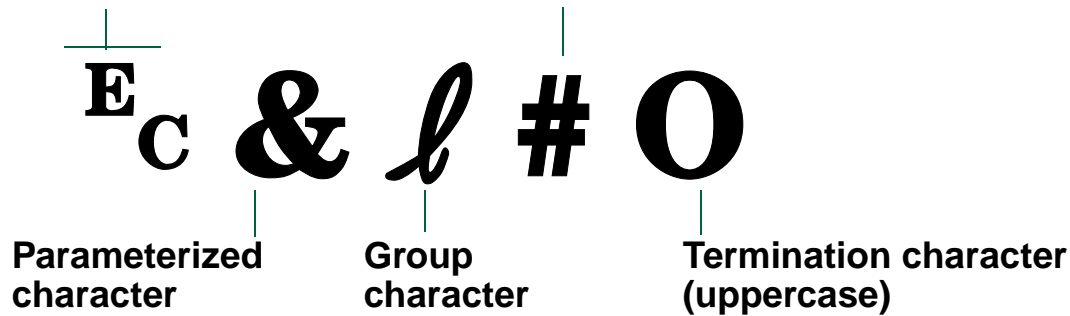

Combining Escape Sequences

Escape sequences may be combined into one escape sequence string. There are three important rules to follow when combining code:

1. The first two characters after the E_C character (the parameterized and group characters) must be the same in all of the commands to be combined.
2. When combining escape sequences, change the uppercase (termination) character in each individual escape sequence to lower case.
3. The final character of the combined escape sequence must be uppercase.

The following is an example of an escape sequence string that would be sent to the printer to select legal paper, landscape orientation, and 8 lines per inch:

```
 $E_C$ &l3A $E_C$ &l1O $E_C$ &l8D
```

The following escape sequence sends the same printer commands by combining them into a shorter sequence:

```
 $E_C$ &l3a1o8D
```



Entering Escape Characters

Printer commands always begin with the escape character (E_C).

The following table shows how the escape character can be entered from various DOS software applications.

DOS Software Application	Entry	What Appears
Lotus 1-2-3 and Symphony	Type \027	027
Microsoft Word for DOS	Hold down Alt and type 027 on the numeric keypad	←
WordPerfect for DOS	Type <27>	<27>
MS-DOS Edit	Hold down Ctrl-P, and press Esc	←
MS-DOS Edlin	Hold down Ctrl-V, and press [^[
dBase	$E_C E_C$ CHR(27)+"command"	$E_C E_C$ CHR(27)+" "



Selecting PCL Fonts

Print a PCL Font List to view the command for each internal font (page [232](#)). A sample section is shown below. Notice the two variable boxes for symbol set and point size.

Univers Medium Scale <esc>(<esc>(s1p v0s0b4148T | 01

These variables must be filled in or the printer will use defaults. For example, if you want a symbol set that contains line-draw characters, select the 10U (PC-8) or 12U (PC-850) symbol set. Other common symbol set codes are listed in the table on page [327](#).

Note

Fonts are either “fixed” or “proportional” in spacing. The printer contains both fixed fonts (Courier, Letter Gothic, and Lineprinter) and proportional fonts (CG Times, Arial®, Times New Roman®, and others).

Fixed-spaced fonts are generally used in applications such as spreadsheets and databases, where it is important for columns to line up vertically. Proportional-spaced fonts are generally used in text and word processing applications.



Common PCL Printer Commands



Function	Command	Options (#)
Job Control Commands		
Reset	E_cE	n/a
Number of Copies	$\text{E}_c\&l\#X$	1 to 999
2-sided/1-sided printing	$\text{E}_c\&l\#S$	0 = Simplex (1-sided) printing 1 = Duplex (2-sided) with long edge binding 2 = Duplex (2-sided) with short edge binding



Function	Command	Options (#)
Page Control Commands		
Paper Source	$\text{E}_c \& l \# H$	0 = prints or ejects current page 1 = Tray 2 2 = manual feed, paper 3 = manual feed, envelope 4 = Tray 1 5 = Tray 3 7 = auto select 8 = Tray 4 20 = Tray 5 21-69 = external trays



Function	Command	Options (#)
Paper size	$\text{E}_c \& l \#A$	1 = Executive 2 = Letter 3 = Legal 25 = A5 6 = 11 x 17 24 = A6 26 = A4 27 = A3 44 = B6-JIS 45 = B5-JIS 46 = B4-JIS 71 = Postcard (single) 72 = Postcard (double) 80 = Monarch 81 = Commercial 10 90 = DL 91 = International C5 100 = B5 101 = Custom



Function	Command	Options (#)
Paper Type	Ⓔ _C &n#	5WdBond = Bond 6WdPlain = Plain 6WdColor = Color 7WdLabels = Labels 9WdRecycled = Recycled 11WdLetterhead = Letterhead 10WdCardstock = Cardstock 11WdPrepunched = Prepunched 11WdPreprinted = Preprinted 13WdTransparency = Transparency #WdCustompapertype = Custom ¹
Orientation	Ⓔ _C & l #O	0 = Portrait 1 = Landscape 2 = Reverse Portrait 3 = Reverse Landscape
Top Margin	Ⓔ _C & l #E	# = number of lines
Text Length (bottom margin)	Ⓔ _C & l #F	# = number of lines from top margin
Left Margin	Ⓔ _C &a#L	# = column number
Right Margin	Ⓔ _C &a#M	# = column number from left margin



Common PCL Printer Commands



Function	Command	Options (#)
Horizontal Motion Index	Ⓔ _C &k#H	1/120-inch increments (compresses print horizontally)
Vertical Motion Index	Ⓔ _C &l#C	1/48-inch increments (compresses print vertically)
Line Spacing	Ⓔ _C &l#D	# = lines per inch (1, 2, 3, 4, 5, 6, 12, 16, 24, 48)
Perforation Skip	Ⓔ _C &l#L	0 = disable 1 = enable



Cursor Positioning

Vertical Position (Rows)	Ⓔ _C &a#R	# = row number
Vertical Position (Dots)	Ⓔ _C *p#Y	# = dot number (300 dots = 1 inch)
Vertical Position (Decipoints)	Ⓔ _C &a#V	# = decipoint number (720 decipoints = 1 inch)
Horizontal Position (Columns)	Ⓔ _C &a#C	# = column number
Horizontal Position (Dots)	Ⓔ _C *p#X	# = dot number (300 dots = 1 inch)



Function	Command	Options (#)
Horizontal Position (Decipoints)	ESC#a#H	# = decipoint number (720 decipoints = 1 inch)
Programming Hints		
End of Line Wrap	ESC&s#C	0 = Enable 1 = Disable
Display Functions On	ESC Y	n/a
Display Functions Off	ESC Z	n/a
Language Selection		
Enter PCL Mode	ESC%#A	0 = Use previous PCL cursor position 1 = Use current HP-GL/2 pen position
Enter HP-GL/2 Mode	ESC%#B	0 = Use previous HP-GL/2 pen position 1 = Use current PCL cursor position



Function	Command	Options (#)
Font Selection		
Symbol Sets ²	Ⓔ _C (#	8U = HP Roman-8 Symbol Set 10U = IBM Layout (PC-8) (code page 437) Default Symbol Set 12U = IBM Layout for Europe (PC-850) (code page 850) 8M = Math-8 19U = Windows 3.1 Latin 1 9E = Windows 3.1 Latin 2 (commonly used in Eastern Europe) 5T = Windows 3.1 Latin 5 (commonly used in Turkey) 579L = Wingdings Font
Primary Spacing	Ⓔ _C (s#P	0 = fixed 1 = proportional
Primary Pitch	Ⓔ _C (s#H	# = characters/inch
Set Pitch Mode ³	Ⓔ _C &k#S	0 = 10 4 = 12 (elite) 2 = 16.5 - 16.7 (compressed)



Function	Command	Options (#)
Primary Height	Ec(s#V	# = points
Primary Style ²	Ec(s#S	0 = upright (solid) 1 = italic 4 = condensed 5 = condensed italic
Primary Stroke Wt. ²	Ec(s#B	0 = medium (book or text) 1 = semi bold 3 = bold 4 = extra bold
Typeface ²	Ec(s#T	Print a PCL font list to view the command for each internal font (page 232).



¹For custom paper, replace “Custompapertype” with the name of the paper, and replace the “#” with the number of characters in the name, plus 1.

²Order the *PCL 5/PJL Technical Reference Documentation Package* for symbol set charts or for more information (page [36](#)).

³The preferred method is to use the primary pitch command.

Multibin Mailbox Commands

Before using these command strings, determine the device identification number of the multibin mailbox by printing a configuration page. The device identification number is located under the heading Installed Personalities and Options. For more information on printing a configuration page, see page [228](#).

The printer must be turned off and on after sending the change mode command in order for the new mode to take effect.

Continued on next page.



DMCMD

The device management command changes the mailbox mode for the defined device.



Syntax: @PJL DMCMD ASCIIHEX = "*asciihexrequest*" <CR><LF>



Parameters:

Parameter	Functional Range	Default
ASCIIHEX = " <i>asciihexrequest</i> "	ASCII 33 through 255	N/A



ASCIIHEX = "*asciihexrequest*" - This is the string that sends the command to change the mailbox mode for the device. The first ASCIIHEX command changes the mailbox mode; the second ASCIIHEX command turns the printer off and on. @PJL DMCMD ASCIIHEX = "*asciihexrequest*" <CR><LF>



Example: The underlined 3 value is the device value determined from the configuration page plus one (1).

```
@PJL DMCMD ASCIIHEX = "0400070104010703030214020104"  
<CR><LF>  
@PJL DMCMD ASCIIHEX = "040006020501010301040105"  
<CR><LF>
```



Continued on next page.



Example to switch to mailbox mode and turn the printer off and on

```
@%12345X@PJJL
```

```
ORD = 10
```

```
@PJJL JOB PASSWORD = 10
```

```
@PJJL DMCMD ASCIIHEX =  
"0400070104010703030214020104" <CR><LF>
```

```
@PJJL DMCMD ASCIIHEX =  
"040006020501010301040105" <CR><LF>
```

```
@PJJL DEFAULT PASSWORD = 0
```

```
@PJJL EOJ
```

```
@%-12345X
```

Continued on next page.



Example to switch to stacker mode and turn the printer off and on

```
@%12345X@PJJL
```

```
ORD = 10
```

```
@PJJL JOB PASSWORD = 10
```

```
@PJJL DMCMD ASCIIHEX =  
"0400070104010703030214020101" <CR><LF>
```

```
@PJJL DMCMD ASCIIHEX =  
"040006020501010301040105" <CR><LF>
```

```
@PJJL DEFAULT PASSWORD = 0
```

```
@PJJL EOJ
```

```
@%-12345X
```

Continued on next page.



Example to switch to separator mode turn the printer off and on

```
@%12345X@PJJL
```

```
ORD = 10
```

```
@PJJL JOB PASSWORD = 10
```

```
@PJJL DMCMD ASCIIHEX =  
"0400070104010703030214020102" <CR><LF>
```

```
@PJJL DMCMD ASCIIHEX =  
"040006020501010301040105" <CR><LF>
```

```
@PJJL DEFAULT PASSWORD = 0
```

```
@PJJL EOJ
```

```
@%-12345X
```



E Regulatory Information



Overview

- [FCC Regulations](#)
- [Environmental Product Stewardship](#)
- [Safety Statements](#)



FCC Regulations

This equipment has been tested and found to comply with the limits for a Class B digital device, pursuant to Part 15 of the FCC rules. These limits are designed to provide reasonable protection against harmful interference in a residential installation. This equipment generates, uses, and can radiate radio frequency energy. If this equipment is not installed and used in accordance with the instructions, it may cause harmful interference to radio communications. However, there is no guarantee that interference will not occur in a particular installation. If this equipment does cause harmful interference to radio or television reception, which can be determined by turning the equipment off and on, the user is encouraged to try to correct the interference by one or more of the following measures:

- Reorient or relocate the receiving antenna.
- Increase separation between equipment and receiver.
- Connect equipment to an outlet on a circuit different from that to which the receiver is located.
- Consult your dealer or an experienced radio/TV technician.

Note

Any changes or modifications to the printer that are not expressly approved by HP could void the user's authority to operate this equipment.

Use of a shielded interface cable is required to comply with the Class B limits of Part 15 of FCC rules.



Environmental Product Stewardship

Protecting the Environment

Hewlett-Packard Company is committed to providing quality products in an environmentally-sound manner. The printer has been designed to minimize impacts on the environment.



The printer design eliminates:

Ozone Production The printer uses charging rollers in the electrophotographic process and therefore generates no appreciable ozone gas (O₃).

CFC Usage Class I U.S. Clean Air Act stratospheric ozone-depleting chemicals (chlorofluorocarbons [CFCs], for example) have been eliminated from the manufacturing of the printer and packaging.



The printer design reduces:

Energy Consumption Energy usage drops from 500/505 (110V/220V units) watts (W) during printing to as little as 35/40 (110V/220V units) W while in low-power (Power Save) mode. This saves energy without affecting the high performance of the printer. This product qualifies for the ENERGY STAR Program (U.S. and Japan). ENERGY STAR is a voluntary program established to encourage the development of energy-efficient office products. The ENERGY STAR name is a registered service mark of the U.S. Environmental Protection Agency.

As an ENERGY STAR partner, Hewlett-Packard Company has determined that this product meets ENERGY STAR Guidelines for energy efficiency.



Toner Consumption EconoMode uses about 50% less toner, thereby extending the life of the toner cartridge.

Paper use The printer's optional duplexing feature, which provides for two-sided printing, reduces paper usage and the resulting demands on natural resources.



The design of the printer facilitates the recycling of:

Plastics

Plastic parts have material identification markings, according to international standards, which enhance the ability to identify plastics for proper disposition at the end of the printer's life.

HP Toner Cartridges

In many countries, this product's toner cartridge/drum can be returned to HP using the prepaid shipping label and instructions included inside each new HP Toner Cartridge box. If your country is not listed in the recycling guide, call your local HP Sales and Service Office for further instructions.

Continued on next page.



HP Cartridge Recycling Program information:

Since 1990, the HP LaserJet Toner Cartridge Recycling Program has collected more than twelve million cartridges that otherwise may have been discarded into landfills. Once a cartridge is returned, it is disassembled and reusable components are cleaned and inspected for quality conformance. After passing strict inspection procedures, materials such as nuts, screws, and clips are reclaimed and used to produce new cartridges. Remaining materials are melted down and used as raw materials for a variety of other products. Over 95 percent (%) of the weight of returned materials is recycled. For more information in the U.S., call (1) (800) 340-2445 or contact the HP LaserJet Supplies Website at <http://ljsupplies.com/planetpartners>. Non-US customers can call the local HP Sales and Service Office for further information regarding the HP Toner Cartridge Recycling Program.



Paper

The printer is suited for the use of recycled papers when the paper meets the guidelines outlined in the *HP LaserJet Printer Family Paper Specifications Guide*.



To ensure printer longevity, HP provides the following:

Extended Warranty	HP SupportPack covers the printer and all HP-supplied internal components. It is a three-year warranty from the date of purchase. HP SupportPack must be purchased by the customer within 30 days of product purchase. Information on HP SupportPack is available by calling your local HP FIRST number. (See the HP Support pages at the front of this user guide.)
Spare Parts and Consumables Availability	Spare parts and consumable supplies for this product will be made available for at least five years after production has stopped.



Material Safety Data Sheet

The Toner Cartridge/Drum MSDS can be obtained by calling the U.S. HP FIRST (Fax Information Retrieval Support Technology) at (1) (800) 231-9300. Use Index number 7 for a listing of the Toner Cartridge/Drum Material/ Chemical Safety Data Sheets. Non-U.S. customers should refer to the HP Support pages at the front of this user guide for appropriate phone numbers and information. For more information in the U.S., call (1) (800) 340-2445 or contact the HP LaserJet Supplies Website at <http://ljsupplies.com/planetpartners>



Environmental Conformity



Plastics

Plastic parts have material identification markings, according to international standards, which enhance the ability to identify plastics for proper disposition at the end of the printer's life. The plastics used in the printer housing and chassis are technically recyclable.

Printer and Parts

Design for recycling has been incorporated into the printer and its accessories. The number of materials has been kept to a minimum while ensuring proper functionality and high product reliability. Dissimilar materials have been designed to separate easily. Fasteners and other connections are easy to locate, access, and remove with common tools. High priority parts have been designed to be accessed quickly for efficient disassembly and repair. Plastic parts have been primarily designed in two colors to enhance recycling options. A few small parts are colored specifically to highlight customer access points.

HP disposes of returned products in an environmentally sound manner. Many of the functional parts are recovered, tested, and reused as fully-warrantied service parts. Used printer parts are not placed into new product manufacturing. The remainder of the product parts are recycled, if possible. For product take-back information, contact your local HP Sales and Service Office (page [245](#)).

Paper

The printer is suited for the use of recycled papers when the paper meets the guidelines outlined in the *HP LaserJet Printer Family Paper Specifications Guide*. The printer is suited for the use of recycled paper according to DIN 19 309.

Acoustics

It is advisable to place printers with a sound power level of $L_{w,d}$ of 6.3 Bel (A) or higher into a separate or divided up room.





Declaration of Conformity

according to ISO/IEC Guide 22 and EN45014

Manufacturer's Name: Hewlett-Packard Company

Manufacturer's Address: 11311 Chinden Boulevard
Boise, Idaho 83714-1021, USA

declares, that the product

Product Name: HP LaserJet 8000, 8000 N, 8000 DN, HP Mopier 240

Model Numbers: C4085A, C4086A, C4087A, C4228A

Product Options: ALL

conforms to the following Product Specifications:

Safety: IEC 950:1991+A1+A2+A3 / EN 60950:1992+A1+A2+A3
IEC 825-1:1993 / EN 60825-1:1994 Class 1 (Laser/LED)



EMC:

CISPR 22:1993+A1 / EN 55022:1994 Class B ¹⁾

CISPR 22:1993+A1 / EN 55022:1994 Class A

EN 50082-1:1992

IEC 801-2:1991 / prEN 55024-2:1992 - 4 kV CD, 8 kV AD

IEC 801-3:1984 / prEN 55024-3:1991 - 3 V/m

IEC 801-4:1988 / prEN 55024-4:1992 - 0.5 kV Signal Lines

1.0 kV Power Lines

FCC Title 47 CFR, Part 15 Class B ²⁾ / ICES-003, Issue 2 / VCCI-B ¹⁾

AS / NZS 3548:1992 / CISPR 22:1993 Class B ¹⁾



Supplementary Information:

The product herewith complies with the requirements of the following Directives and carries the CE-marking accordingly:

the EMC directive 89/336/EEC

the Low Voltage Directive 73/23/EEC



The product was tested in a typical configuration with Hewlett-Packard Personal Computer Systems.

This Device complies with Part 15 of the FCC Rules. Operation is subject to the following two conditions: (1) this device may not cause harmful interference, and (2) this device must accept any interference received, including interference that may cause undesired operation.



This printer contains Local Area Network (LAN) options. When the Interface Cable is attached to either of the IEEE 802.3 connectors, the printer meets the requirements of EN 55022 Class A.



January 15, 1997

For Compliance Information ONLY, contact:

Australia Contact: Product Regulations Manager, Hewlett-Packard Australia Ltd., 31-41 Joseph Street, Blackburn, Victoria 3130, Australia



European Contact: Your Local Hewlett-Packard Sales and Service Office or Hewlett-Packard GmbH, Department HQ-TRE / Standards Europe, Herrenberger Straße 130, D-71034 Böblingen (FAX: +49-7031-14-3143)



USA Contact:

Product Regulations Manager, Hewlett-Packard Company,
PO Box 15 Mail Stop 160, Boise, ID 83707-0015 (Phone:
208-396-6000)



Safety Statements

Laser Safety Statement

The Center for Devices and Radiological Health (CDRH) of the U.S. Food and Drug Administration has implemented regulations for laser products manufactured since August 1, 1976. Compliance is mandatory for products marketed in the United States. The printer is certified as a “Class 1” laser product under the U.S. Department of Health and Human Services (DHHS) Radiation Performance Standard according to the Radiation Control for Health and Safety Act of 1968. Since radiation emitted inside the printer is completely confined within protective housings and external covers, the laser beam cannot escape during any phase of normal user operation.

WARNING!

Using controls, making adjustments, or performing procedures other than those specified in this user’s guide may result in exposure to hazardous radiation.

Canadian DOC Regulations

Complies with Canadian EMC Class B requirements.

<<Conforme á la classe B des normes canadiennes de compatibilité électromagnétiques. << CEM>>.>>



VCCI Statement (Japan)

この装置は、情報処理装置等電波障害自主規制協議会（VCCI）の基準に基づく第二種情報技術装置です。この装置は、家庭環境で使用することを目的としていますが、この装置がラジオやテレビジョン受信機に近接して使用されると、受信障害を引き起こすことがあります。
取り扱い説明書に従って正しい取り扱いをして下さい。



Korean EMI statement

사용자 안내문 (B급 기기)

이 기기는 비업무용으로 전자파장해검정을 받은 기기로서, 주거지역에서는 물론 모든 지역에서 사용될 수 있습니다.



Laser Statement for Finland

LASERTURVALLISUUS

LUOKAN 1 LASERLAITE

KLASS 1 LASER APPARAT

HP LaserJet 8000, 8000 N, 8000 DN -laserkirjoitin on käyttäjän kannalta turvallinen luokan 1 laserlaite. Normaalisessa käytössä kirjoittimen suojakotelo estää lasersäteiden pääsyn laitteen ulkopuolelle.

Laitteen turvallisuusluokka on määritetty standardin EN 60825-1 (1993) mukaisesti.

VAROITUS !

Laitteen käyttäminen muulla kuin käyttöohjeessa mainitulla tavalla saattaa altistaa käyttäjän turvallisuusluokan 1 ylittävälle näkymättömälle lasersäteilylle.

WARNING !

Om apparaten används på annat sätt än i bruksanvisning specificerats, kan användaren utsättas för osynlig laserstrålning, som överskrider gränsen för laserklass 1.

HUOLTO



HP LaserJet 8000, 8000 N, 8000 DN -kirjoittimen sisällä ei ole käyttäjän huollettavissa olevia kohteita. Laitteen saa avata ja huoltaa ainoastaan sen huoltamiseen koulutettu henkilö. Tällaiseksi huoltotoimenpiteeksi ei katsota väriainekasetin vaihtamista, paperiradan puhdistusta tai muita käyttäjän käsikirjassa lueteltuja, käyttäjän tehtäväksi tarkoitettuja ylläpitotoimia, jotka voidaan suorittaa ilman erikoistyökaluja.

VARO !

Mikäli kirjoittimen suojakotelo avataan, olet alttiina näkymättömälle lasersäteilylle laitteen ollessa toiminnassa. Älä katso säteeseen.

VARNING !

Om laserprinterns skyddshölje öppnas då apparaten är i funktion, utsätts användaren för osynlig laserstrålning. Betrakta ej strålen.

Tiedot laitteessa käytettävän laserdiodin säteilyominaisuuksista:

Aallonpituus 770-795 nm

Teho 5 mW

Luokan 3B laser



Index



A

[accessories](#) 33
 [hard disk](#) 35, 320
 [ordering](#) 36
[acoustic emission](#) 277
[AutoCAD printer driver](#) 57

B

[bin](#)
 [left output](#) 92
 [multibin mailbox](#) 93
 [standard](#) 90

C

[cable configuration](#) 210
[cleaning page](#) 143
[cleaning the printer](#) 141
[clearing paper jam](#) 155
[configuration description](#) 29
[configuration menu](#)
 [run location menu item](#) 319
[configuration page](#)
 [checking](#) 227

[printing](#) 228
[connectivity](#) 28
[control panel](#)
 [keys](#) 46
 [layout](#) 44
 [lights](#) 45
 [messages](#) 168
 [printing a menu map](#) 231
[control panel menus](#) 308
 [about](#) 48
 [EIO \(8000N/8000DN\)](#) 305
 [I/O](#) 302
 [information](#) 281
 [paper handling](#) 283
 [printing a map](#) 49
[customer support](#) 12
[custom-sized paper](#)
 [setting](#) 123

D

[Declaration of Conformity](#) 349
[default setting, restoring](#) 308
[DIMMs](#)





[about](#) 25
[installing](#) 312
[verifying](#) 315
[dual in-line memory module](#)
See DIMMs
[duplexer](#)
[paper jam](#) 157
[problem solving](#) 211

E

EIO

[installing](#) 320
[slots](#) 28
[EIO Menu \(8000N/8000DN\)](#) 305
[envelope](#)
[specification](#) 267–270
[envelope feeder](#) 155
[problem solving](#) 211
[size setting](#) 283
[type setting](#) 283

[environmental product stewardship](#) 342–349
[escape character](#) 325
[escape sequences](#) 324

F

[FCC statement](#) 341
[Finland laser statement](#) 355

[font list, printing](#) 232
[FontSmart](#) 67

H

[hard disk](#)
[installing](#) 320
[problem solving](#) 212
[hard disk, optional](#) 35
[help, printer driver](#) 65
[HP support services](#) 3

I

[I/O buffering](#) 318
[I/O menu](#) 302
[information menu](#) 281
[installing software](#)
[Windows 3.1x](#) 60
[Windows 95 and NT 4.0](#) 59

J

[JetAdmin](#) 72
[installing](#) 53
[JetDirect](#)
[EIO](#) 221
[JetSend, installing](#) 68

L[label](#)[specification 265](#)[laser statement for Finland 355](#)[LEDs](#)[status interpretation 50](#)**M**[Macintosh 62](#)[LaserJet Utility 69](#)[PPDs 69, 219](#)[problem solving 217](#)[maintenance](#)[cleaning page 143](#)[cleaning the printer 141](#)[manual feed 133](#)[mass storage](#)[installing 320](#)[memory](#)[about 25](#)[adjusting settings 316](#)[allocated to languages 316](#)[decreasing page processing time 319](#)[I/O buffering 318](#)[installing 312](#)[resource saving 316](#)[verifying 315](#)[Memory Enhancement technology \(MEt\) 25](#)[mopying](#)[see also printer collation 125](#)[multibin mailbox](#)[5-bin with stapler problem solving 203](#)[paper jam 162](#)[problem solving 206](#)**N**[network](#)[problem solving 215](#)[network software](#)[installing 61](#)[JetAdmin 53, 72](#)[n-up printing 130](#)**O**[OS/2 printer drivers 57](#)[output bin](#)[selecting 88](#)**P**[paper](#)[custom or heavy stock 123](#)[different first page 128](#)[input](#)[loading Optional 2x500-sheet 80](#)



[loading tray 1](#) 76
[loading tray 2 and 3](#) 80
[loading tray 4](#) 84
[multiple pages on one sheet](#) 130
[output](#)
 [left bin](#) 92
 [multibin mailbox](#) 93
 [standard bin](#) 90
[selecting by size and type](#) 134
[selecting output location](#) 88
[source](#) 76
 See also [Tray](#)
[paper handling](#)
 [menu](#) 283
 [options](#) 27
[paper jam](#) 153
 [2x500-sheet tray](#) 151
 [duplexer](#) 157
 [envelope feeder](#) 155
 [fuser area or left door](#) 161
 [multibin mailbox](#) 162
 [output areas](#) 160
[problem solving](#)
 [paper jams](#) 146
 [right door](#) 149
 [top cover area](#) 159
 [trays 2 and 3](#) 150

[paper jams](#)
 [tray 1](#) 148
[paper specifications](#) 262
[paper specification](#)
 [about](#) 254
 [card stock or heavy paper](#) 271
 [envelopes](#) 267
 [labels](#) 265
 [recycled paper](#) 254
 [transparencies](#) 266
[PPDs](#) 219
[print quality](#) 186
 [problem solving](#) 186
[print servers](#) 28
[printer](#)
 [accessories](#) 33
 [features](#) 25
 [parts location](#) 31
 [specification](#) 273
 [supplies](#) 33
[printer collation \(mopying\)](#) 125
[printer configuration](#) 29
[printer driver](#)
 [accessing windows drivers](#) 63
 [choosing the right one](#) 64
 [different first page](#) 128
 [help](#) 65



[included](#) 56
[multiple pages on one sheet](#) 130
[obtaining most recent](#) 57
[PPD](#) 219
[PPDs](#) 56
[printing a watermark](#) 127
[RIP ONCE](#) 126
[saving setup information](#) 126
[selecting by size and type](#) 134
[printer language](#)
 [about](#) 26
 [allocating memory](#) 316
[problem solving](#) 186
 [checklist](#) 188
 [common problems](#) 191
 [Macintosh](#) 217
 [network and I/O port](#) 215
 [paper jam locations](#) 147
 [PS errors](#) 213

R

[resets menu](#) 308
[Resolution Enhancement technology \(REt\)](#) 25
[RIP ONCE](#) 126

S

[sales and service offices](#) 245– 252

[service and support information](#) 236
[software](#) 67
 [about](#) 52
 [JetAdmin](#) 72
 [JetSend](#) 68
 [LaserJet Utility](#) 69
 [Macintosh](#) 62
 [obtaining most recent](#) 57
 [PPDs](#) 56
 [ToolBox](#) 66
 [Web JetAdmin](#) 71
[stapler](#)
 [clearing jams](#) 164
 [solving repeating paper jams](#) 166
[supplies, ordering information](#) 36
[support services](#) 3

T

[toner cartridge](#)
 [life expectancy](#) 138
 [limited warranty](#) 240
 [managing](#) 137
 [printing with low toner](#) 139
[ToolBox](#) 66
[transparency, specification](#) 266
[Tray 1](#)
 [clearing paper jams](#) 148



[customizing](#) 131
[loading](#) 76
[manual feed](#) 133
[problem solving](#) 199
[Tray 2 and 3](#)
[loading](#) 80
[paper jam](#) 150
[Tray 4](#)
[2000-sheet input tray](#) 84
[paper jam](#) 153
[problem solving](#) 201
[tray 4](#) 153
[Tray 4 and 5](#)
[loading](#) 80
[paper jam](#) 151

[troubleshooting](#). See [problem solving](#)

V

[VCCI statement \(Japan\)](#) 354

W

[warranty statement](#) 237

[watermark](#) 127

[Web JetAdmin](#) 71

[web servers, supported](#) 71

[Windows 3.1x](#) 60

[Windows 95 and NT 4.0](#) 59

[WordPerfect 5.1 printer driver](#) 57

[World Wide Web support](#) 3