

imageCLASS

MF4890dw / MF4880dw / MF4770n

Starter Guide

1

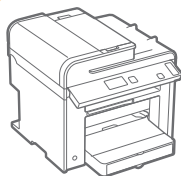

Preface

➔ P.2

2



Installing the Machine

➔ P.4

3



Connecting to a Computer
and Installing the Drivers

➔ P.12

4



Configuring and
Connecting the Fax







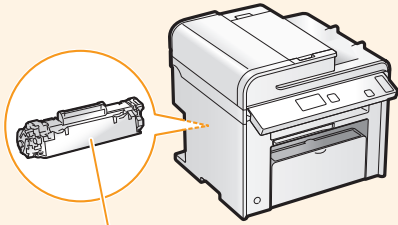
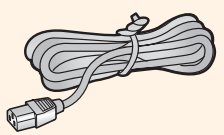

➔ P.24

Read this guide first.

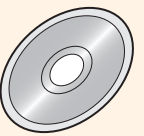
Please read this guide before operating this product. The remarks for important safety instructions are described in the Basic Operation Guide. After you finish reading the Starter Guide, store it in a safe place for future reference.

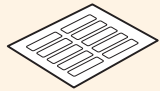
Checking the Supplied Accessories

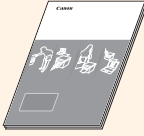
Confirm that all the supplied accessories are contained in the box. If an item is missing or damaged, please contact the Canon Authorized Service Facilities or the Canon Customer Care Center.

<p>Machine Unit</p>  <p>The toner cartridge is already installed.</p>	<p>Power Cord</p> 
<p>Telephone Cable</p> 	<p>User Software CD-ROM</p> 
<p>Starter Guide</p> 	<p>Speed Dial Label</p> 
<p>Wireless LAN Setting Guide (MF4890dw/MF4880dw Only)</p> 	<p>Limited Warranty Notice</p> 
<p>Basic Operation Guide</p> 	<p>Registration Card</p> 

About the LAN and USB cable

The machine does not come with a LAN cable, USB cable, or a hub. Have cables or a hub ready as needed.

- Please use LAN Cable of Category 5 twisted pair cable or higher for support.
- When connecting the machine to a 100BASE-TX Ethernet network, all the devices on the LAN must be compatible with 100BASE-TX.

Supplied Toner Cartridge

- The included "Canon Cartridge 128 Starter" can print an average yield of 1,000 sheets*. The average yield of the replacement toner cartridge differs from the supplied toner cartridge.
- To purchase replacement toner cartridges:
 - ➔ "Replacement Toner Cartridges" in the e-Manual

* The average yield is based on "ISO/IEC 19752" when printing A4 size paper with the default printing density.

User Software CD-ROM

The User Software CD-ROM contains the MF Drivers, MF Toolbox, various software, and the e-Manual.*1

MF Drivers

The MF Driver contains the Network Scan Utility*2 (to use to scan over a network) as well as printer, fax, and scanner drivers.

MF Toolbox

The MF Toolbox provides a group of commands for you, such as to open a scanned image in an application, send it as an e-mail attachment file, and store it on the hard disk.

Miscellaneous Software

The User Software CD-ROM contains Presto! PageManager. Install it from the [Custom Installation] option.

*1 See "Using the e-Manual" (P.31).

*2 Windows 7/Vista/XP only.

Included Documents

Printed Manuals

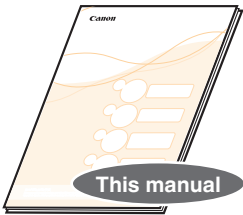

Starter Guide

This manual describes the configuration and software installation.

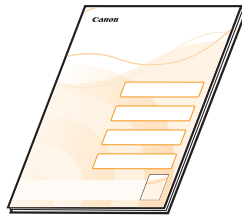

Wireless LAN Setting Guide

(MF4890dw/MF4880dw Only)

This manual explains the wireless LAN setup procedures and troubleshooting during the setup.

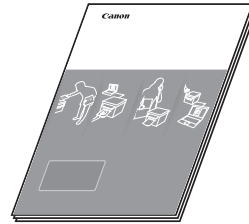

Basic Operation Guide

This manual describes the basic use of the machine.

Manuals Included in the CD-ROM

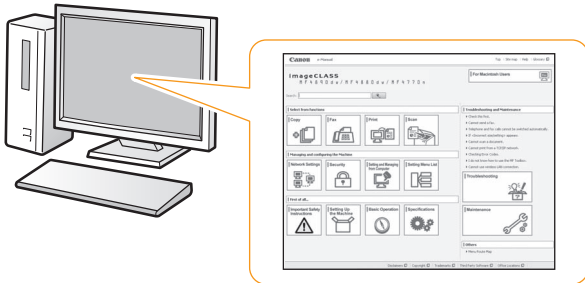

e-Manual

This manual explains all the features of the machine, and is categorized by subject. For details about using the e-Manual, see "Using the e-Manual" (P.31).

Removing the Packing Materials

Remove all the packing materials, such as orange tape. Packing materials may change in form or placement, or may be added or removed without prior notice.

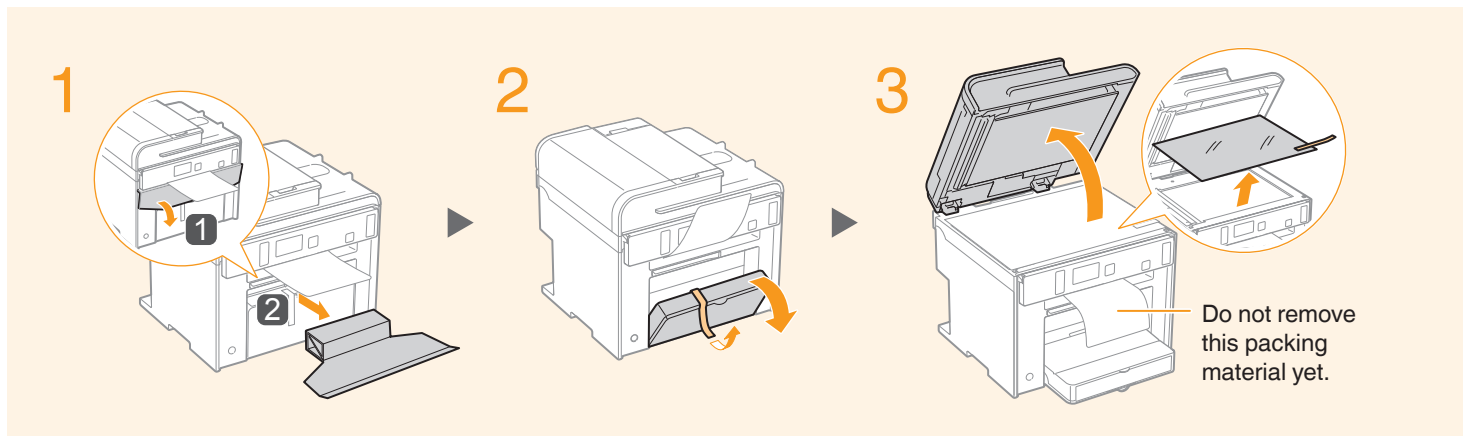

Establishing an Installation Site

MF4890dw

- ① 31 1/4" (793 mm)
- ② 24 5/8" (626 mm)
- ③ 29 1/4" (741 mm)

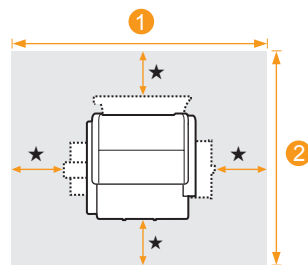

★ = 4" (100 mm)

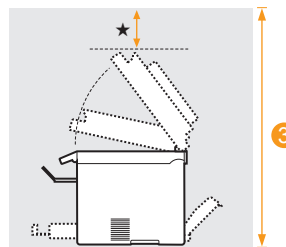

MF4880dw

- ① 31 1/4" (793 mm)
- ② 24 5/8" (626 mm)
- ③ 28 1/2" (723 mm)

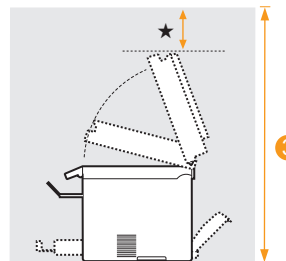
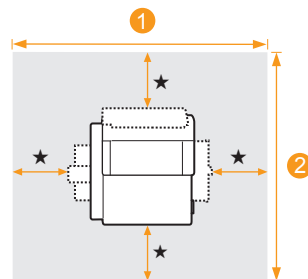

MF4770n

- ① 29 3/4" (755 mm)
- ② 24 5/8" (626 mm)
- ③ 28 1/2" (723 mm)

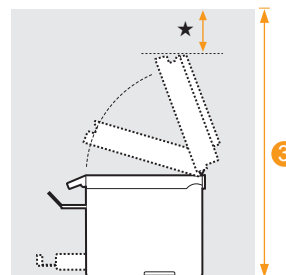
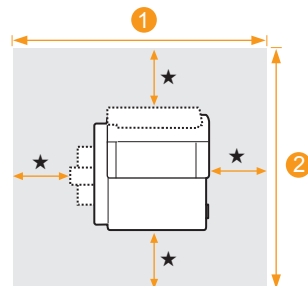

4

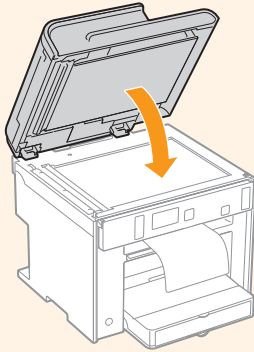

Check!

Are all the packing materials removed?

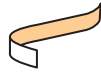

Tape

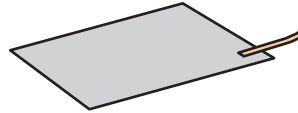

Packing Material with tape

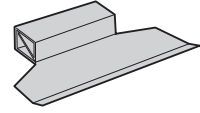

Packing Material

Do not place the machine near the following:

- Alcohol, paint thinner, or other flammable substances ▶ If flammable substances come into contact with electrical parts inside the machine, this may result in a fire or electrical shock.
- Any medical equipment ▶ Radio wave emitted from this machine may interfere with medical equipment.
- Surfaces that are unstable, subject to excessive vibration, objects that could block the ventilation slot, dampness or dust, in direct sunlight or exposed to the elements, subject to high temperatures, open flames, and poor ventilation ▶ Installing the machine in locations with these characteristics may result in personal injury, fire, or electric shock.

Ozone from the Unit

Although ozone is generated from the machine during operation, it does not have any affect on the human body. However, if you intend to use the machine for long periods of time, ensure that the installation location is well ventilated for a comfortable working environment.

Proper Handling

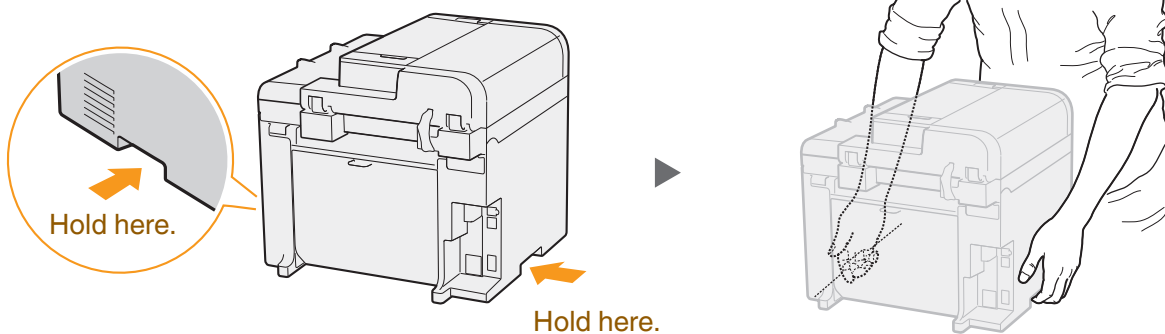

Preparing the Toner Cartridge

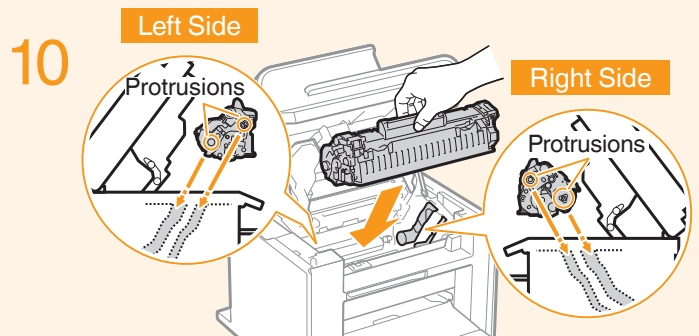
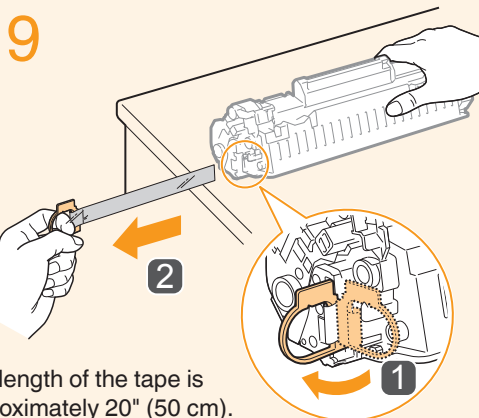
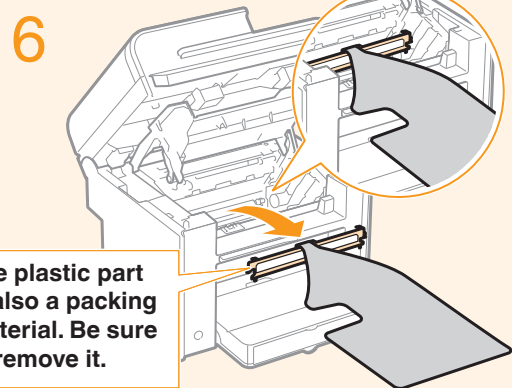
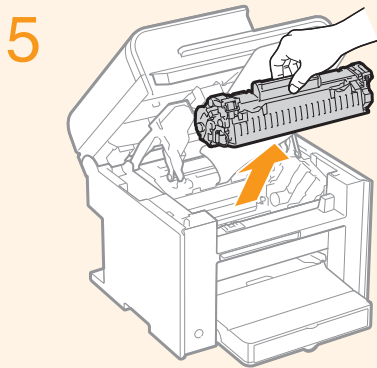
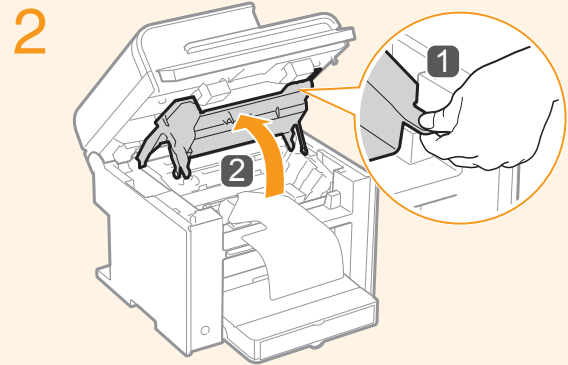
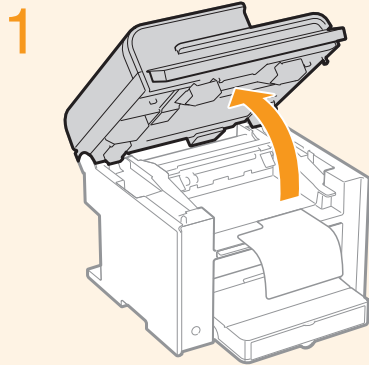

Fit the protrusions on each side of the toner cartridge, and then slide the toner cartridge into the machine.

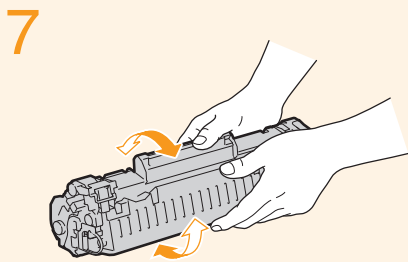
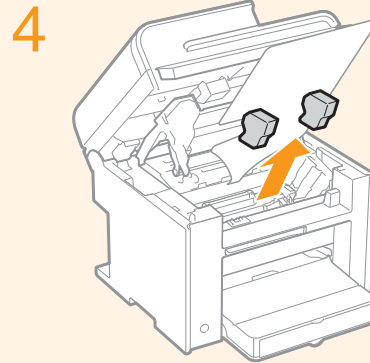
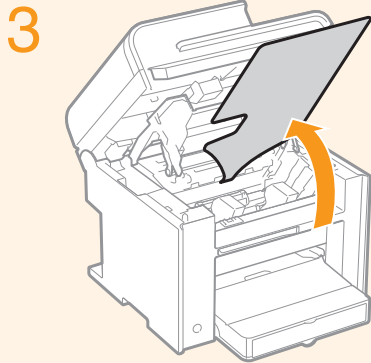

Shake 5 to 6 times.

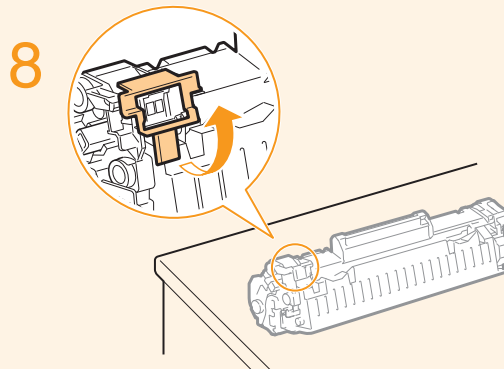

Place on a flat surface.

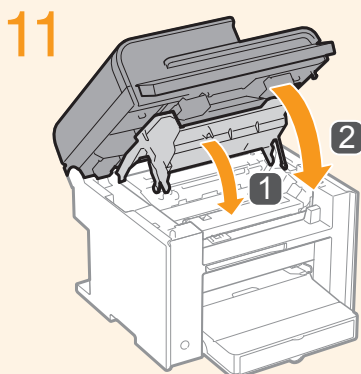

Check!

Are all the packing materials removed?



Packing materials

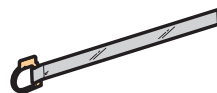

Sealing tape

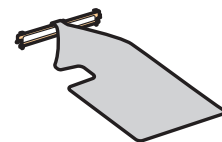

Packing material with a sheet

Loading Paper

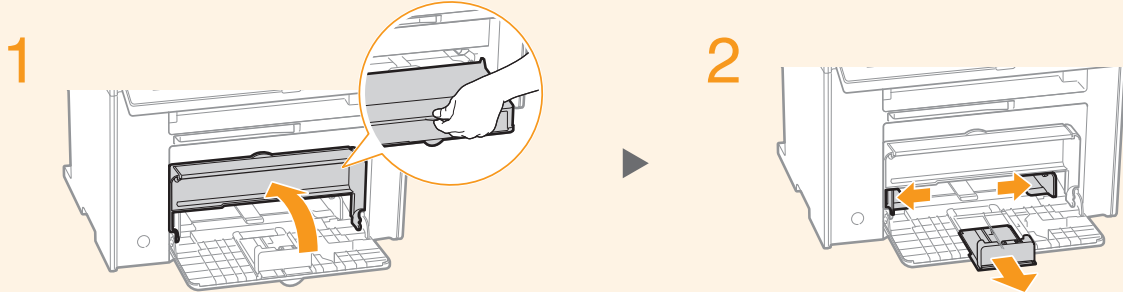

Spread the paper guides a little wider than the width and length of the paper.



Adjust the paper guides tightly to the width and length of the paper.

Loading Paper Other than Letter Size

The procedure here is for loading Letter size paper. To load paper other than Letter size, such as Legal or Statement, see “Loading Paper Other than Letter Size” (P.29) after finishing the initial settings.

3

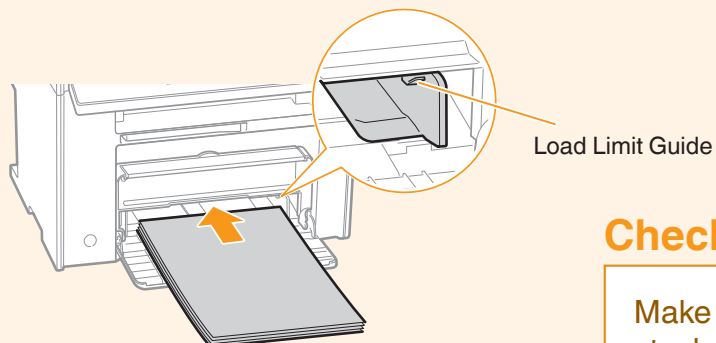

Push until the edge of the paper stack meets the back of the paper cassette.

Check!

Make sure that the paper stack does not exceed the load limit guide.

Use the paper stopper when printing.

Pull out the paper stopper to prevent the paper from falling out of the output tray.

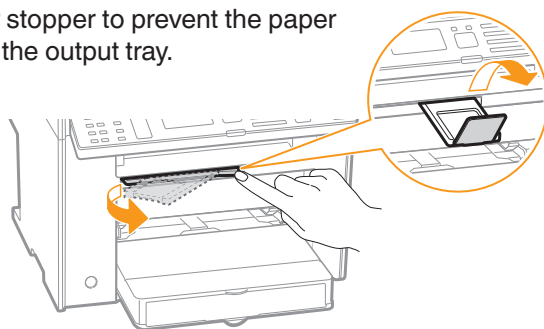

1 Push out the output tray extension, and then pull it out.

2 Lift the paper stopper.

Connecting the Power Cord

1

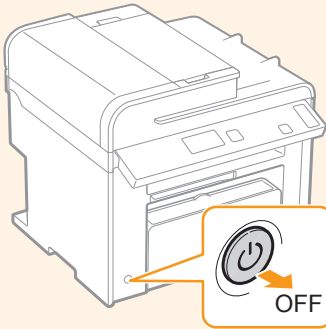

Make sure that the machine is turned OFF.

Do not connect the USB cable.
Connect the cable when installing the software.

2

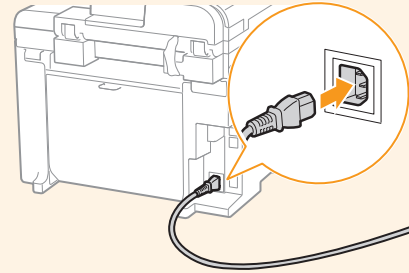

4 Press [▲] or [▼] to highlight a language, and then press [OK].

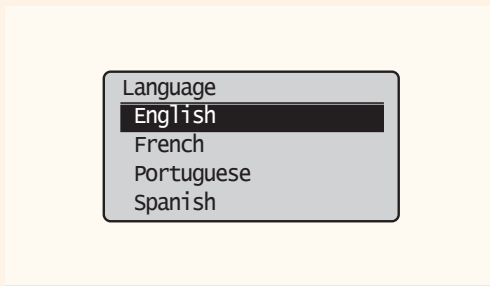

5 Press [▲] or [▼] to highlight a region, and then press [OK].

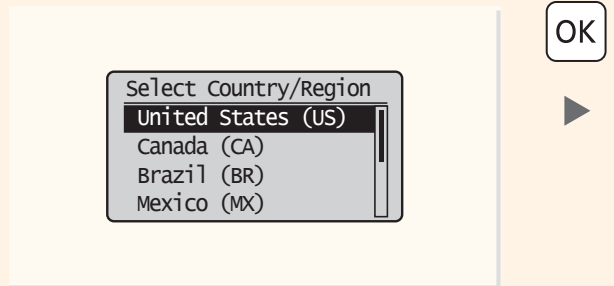

7 Enter the date and time, and then press [OK].

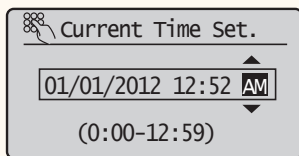

- Press [◀] or [▶] to move the cursor to the left and right.
- Press [▲] or [▼] to change the numeric value, or AM/PM.

※ The factory default settings for time display is set as 12-Hour.

8 Select a connection method.
(MF4890dw/MF4880dw only)

OK

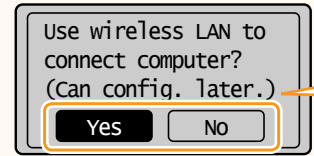

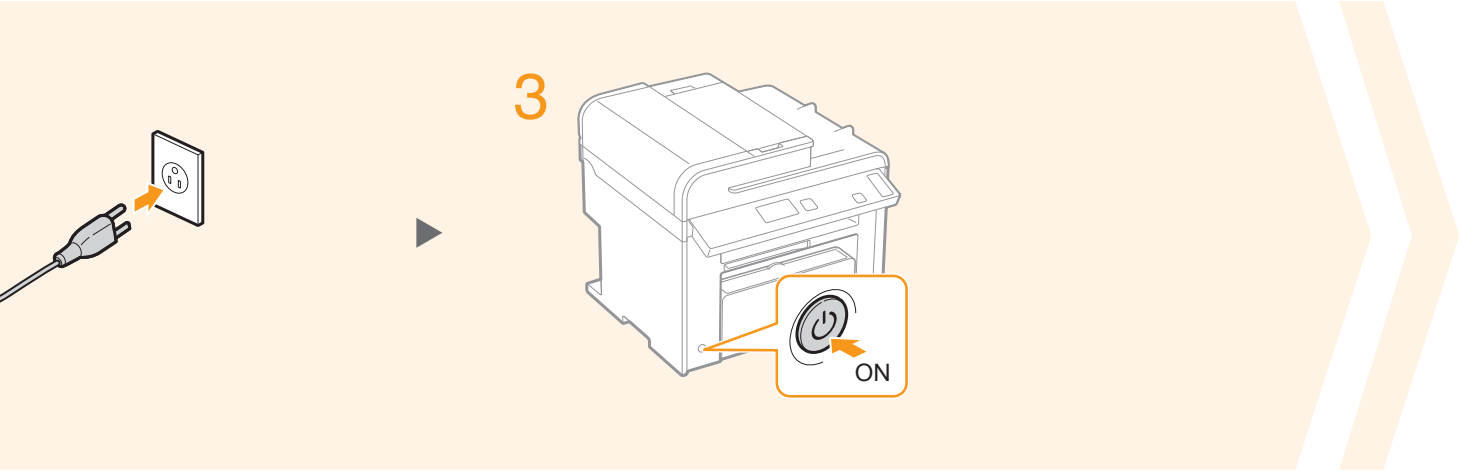

6 Press [OK].



Yes

Connect to the computer via a wireless LAN immediately.

- ➔ Start from step ④ on P.4 in the Wireless LAN Setting Guide.

NO

Proceed to the next step.

Select <No> also when you connect to the computer via a wireless LAN later.

9 Confirm the screen, and then press [OK].

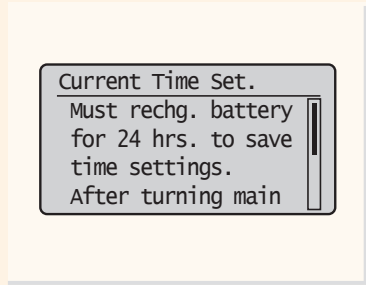

- Connect to the computer via a wired LAN
 - ➔ Proceed to the next page.
- Connect to the computer via a USB cable
 - ➔ Proceed to the next page.
- Do not connect to PC
 - ➔ Proceed to "Configuring the Fax" (P.24).

Connecting to the Computer

Check! Choosing the Method to Connect the Machine to the Computer

First, you need to decide on the method you would like to connect your machine to the computer. Choose from the following three options.



Connecting via a Wired LAN

You can connect the machine to the computer through a wired router. Use the LAN cables to connect the machine to the wired router (or hub).

- ※ Make sure that there is an available port in the router to connect the machine and the computer.
- ※ Have a LAN Cable of Category 5 twisted-pair cable or higher ready.

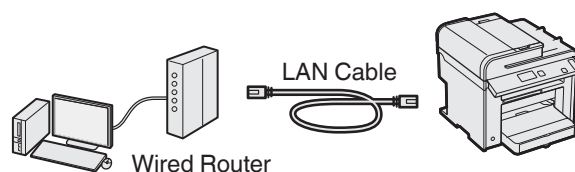

Windows

➔ P.13

Macintosh

➔ P.15



Connecting via a USB

You can connect the machine to the computer using a USB cable.

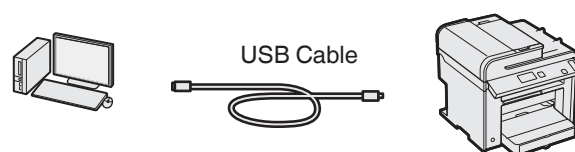

Windows

➔ P.19

Macintosh

➔ P.21



Connecting via a Wireless LAN

(MF4890dw/MF4880dw Only)

You can connect the machine to the computer through a wireless router*. Since it is connected wireless, no LAN cables are needed.

* A wireless router (or access point) which supports IEEE802.11b/g/n is required.

➔ See "Wireless LAN Setting Guide"

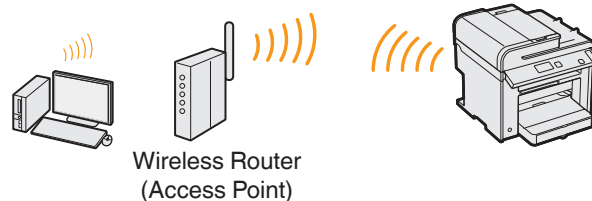

- ※ If you are looking to install your new device via a Wireless Network connection, you can find a video and written guides with step-by-step instruction to assist you through the process from the following URL: www.usa.canon.com/WirelessHelp
Viewing these guides will ensure a smooth setup of the device into your existing wireless environment.

If you do not sure whether your router is wired or wireless:

See the instruction manual provided with your network device, or contact the manufacturer.

1

Wired LAN Connection

Check the following first. Windows



1 Are the computer and the router (or hub) properly connected using a LAN cable?

For details, see the instruction manual provided with your network device, or contact the manufacturer.

2 Have the network settings on the computer been complete?

If the computer is not properly configured, you may not use the wired LAN connection even after completing the following settings.

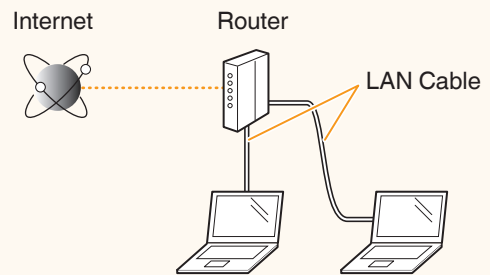

NOTE

- You cannot connect both the wired LAN and wireless LAN at the same time.
- When you connect to a network environment that is not security protected, your personal information could be disclosed to third parties. Please use caution.
- If you connect through a LAN in the office, contact your network administrator.

2

Wired LAN Connection

Connect the LAN cable. Windows



The machine does not come with a LAN cable, router, or a hub. Have LAN Cable of Category 5 twisted pair cable or higher ready.

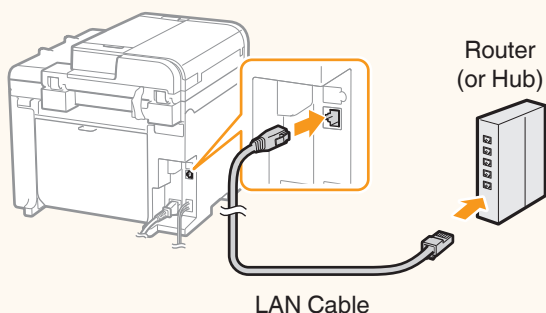

If the IP address on this machine has been changed:

If the machine is on the same subnet as the computer, the connection is maintained.

* If you want to manually configure the IP address:

If you have set a static IP address to the IP address of the computer, manually configure a static IP Address.

➔ "Setting the IP Address" in the e-Manual

Wait for approximately 2 minutes.
The IP address will be automatically configured.*

Connecting to the Computer

3

Wired LAN Connection

Install the software. Windows



Install the MF Drivers and the MF Toolbox. Make sure that the machine is turned ON, and log on to Windows as a user with administrative privileges. Shut down all applications that are running. See the e-Manual for details about installation.

NOTE

- If you are operating in the IPv6 environment, you may not install the software following the procedures below. See “Installing the MF Drivers on the WSD Network” in the e-Manual.
- You may not use the scan function in the IPv6 environment.

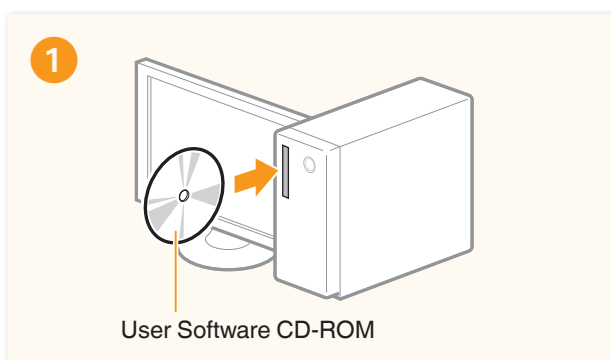

User Software CD-ROM

2

Canon CD-ROM Setup

You can install software programs etc. on this screen. Select a menu on the right.

Easy Installation ◀ Click!

Custom Installation

Additional Software Programs

Display Manuals

Online User Registration

Exit

- Printer, fax, scanner drivers and MF Toolbox will be installed.
- Select [Custom Installation] to install Presto! PageManager and the e-Manual.

If the screen is not correctly displayed:

- Windows XP/Server 2003
[Start] Menu → [Run] → enter [D:\MInst.exe*] → [OK]
- Windows Vista/7/Server 2008
[Start] Menu → [Search programs and files] (or [Start Search]) → enter [D:\MInst.exe*] → press the [Enter] key

* The CD-ROM drive name is indicated as "D:" in this manual.



Follow the instructions on the screen to continue.

4

Exit CD-ROM Setup

STEP 1 License Agreement

STEP 2 Install

STEP 3 Done

Restart Computer Now (Recommended) ◀ Select ✓

Restart ◀ Click!

- Take the CD-ROM out, if necessary.

Computer connection via the wired LAN is now complete.

➡ Proceed to P.24 to configure the fax.

1

Wired LAN Connection

Check the following first. Macintosh



1 Are the computer and the router (or hub) properly connected using a LAN cable?

For details, see the instruction manual provided with your network device, or contact the manufacturer.

2 Has the network settings on the computer been complete?

If the computer is not properly configured, you may not use the wired LAN connection even after completing the following settings.

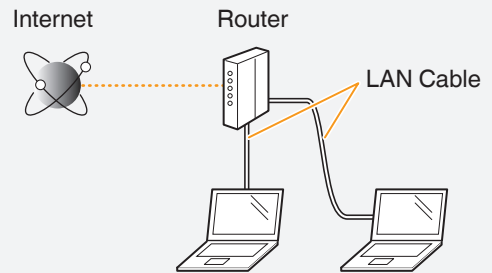

NOTE

- You cannot connect both the wired LAN and wireless LAN at the same time.
- When you connect to a network environment that is not security protected, your personal information could be disclosed to third parties. Please use caution.
- If you connect through a LAN in the office, contact your network administrator.

2

Wired LAN Connection

Connect the LAN cable. Macintosh



The machine does not come with a LAN cable, router, or a hub. Have LAN Cable of Category 5 twisted pair cable or higher ready.

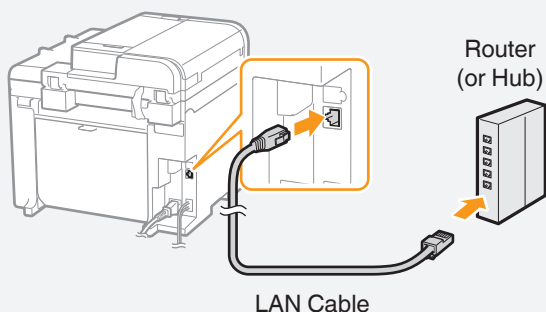

If the IP address on this machine has been changed:

If the machine is on the same subnet as the computer, the connection is maintained.

*** If you want to manually configure the IP address:**

If you have set a static IP address to the IP address of the computer, manually configure a static IP Address.

➔ "Setting the IP Address" in the e-Manual

Wait for approximately 2 minutes.

The IP address will be automatically configured.*

Connecting to the Computer

3 Wired LAN Connection **Macintosh**

Install the MF drivers for Macintosh. It requires Mac OS X 10.5.8 version or later. The installation screen varies depending on the version of Mac OS X.

This operation is for Macintosh. If using Windows, proceed to P.14.

1

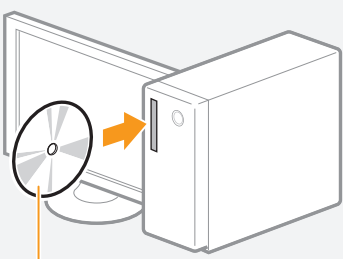

Insert the User Software CD-ROM and double-click the CD-ROM icon.

2



Double-click!

Follow the instructions on the screen to continue.

3

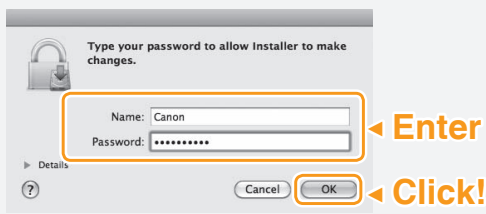

Enter

Click!

- Depending on the system environment, the dialog box may not be displayed. In this case, proceed to next step.

4

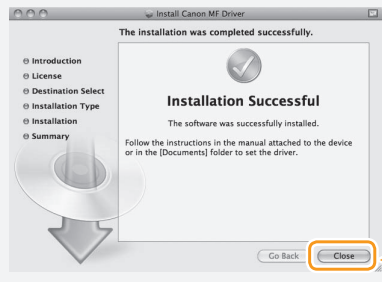

Click!

- Installing the drivers is now complete. Continued with registration operations on the desktop.

5



Click!



Click!

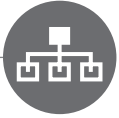

6

Click! **+**

- If you are using Mac OS X 10.5.8, click [+], select [CanonMF4800] or [CanonMF4700] from the dialog box displayed, and then proceed to next step..

7

1 Click! **+**

2 Select

3 Select

4 Click!

- 2 Select a printer name for which [Bonjour] is displayed in the [Kind] or [Connection] column.
- 3 If you are using Mac OS X 10.5.x, select the corresponding driver from [Print Using].
- An IP address is automatically configured by the Bonjour function. If there is not the Bonjour function or you want to set the IP address manually, see "Setting the IP Address" in the e-Manual.

Connecting with the manual setting

Click! **IP**

Select

Enter

Select

Select

Click!

Proceed to P.18

Connecting to the Computer

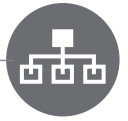

Macintosh

Click!

- If you are using Mac OS X 10.5.x, select [Select a driver to use] and the corresponding driver from [Print Using], and then click [Add].

8 **Click!**

1 **Click!** Check that this machine is added.

Computer connection via the wired LAN is now complete.

➔ Proceed to P.24 to configure the fax.

1

USB Connection

Install the software. Windows



Install the MF Drivers and the MF Toolbox. Make sure that the machine is turned ON, and log on to Windows as a user with administrative privileges. Shut down all applications that are running. See the e-Manual for details about installation.

Do not connect the USB cable yet.

Connect the USB cable after installing the MF Drivers and the MF Toolbox.

If you already connected the USB cable:

Windows 7: ① Disconnect the USB cable from the computer, ② and then proceed to step ①.

Windows Vista/XP: ① If the dialog box on the right appears, disconnect the USB cable from the computer*, ② click [Cancel], ③ and then proceed to step ①.

* If the USB cable is disconnected and the dialog box disappears, proceed to step ①.

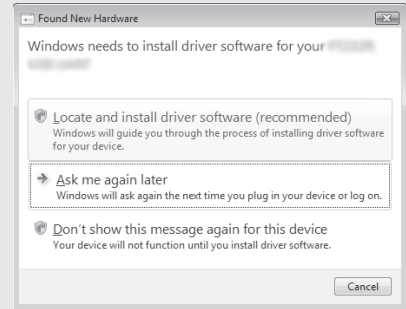

For Windows Vista/XP

1

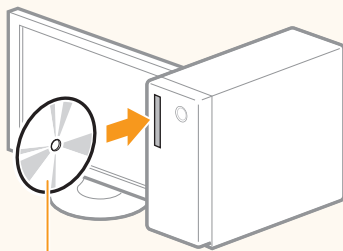

User Software CD-ROM

2



- Printer, fax, scanner drivers and MF Toolbox will be installed.
- Select [Custom Installation] to install Presto! PageManager and the e-Manual.

If the screen is not correctly displayed:

- Windows XP/Server 2003
[Start] Menu → [Run] → enter [D:\MInst.exe*]
→ [OK]

- Windows Vista/7/Server 2008
[Start] Menu → [Search programs and files]
(or [Start Search]) → enter [D:\MInst.exe*] →
press the [Enter] key

* The CD-ROM drive name is indicated as "D:" in this manual.

Follow the instructions on the screen to continue.

3

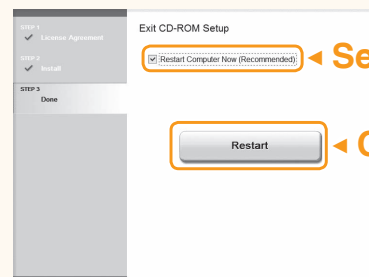

- Remove the CD-ROM, if necessary.

Proceed to P.20

Connecting to the Computer

2

USB Connection

Connect the **USB cable**. **Windows**



After installing the software, such as MF Driver, connect the USB cable. Make sure the software is installed first.

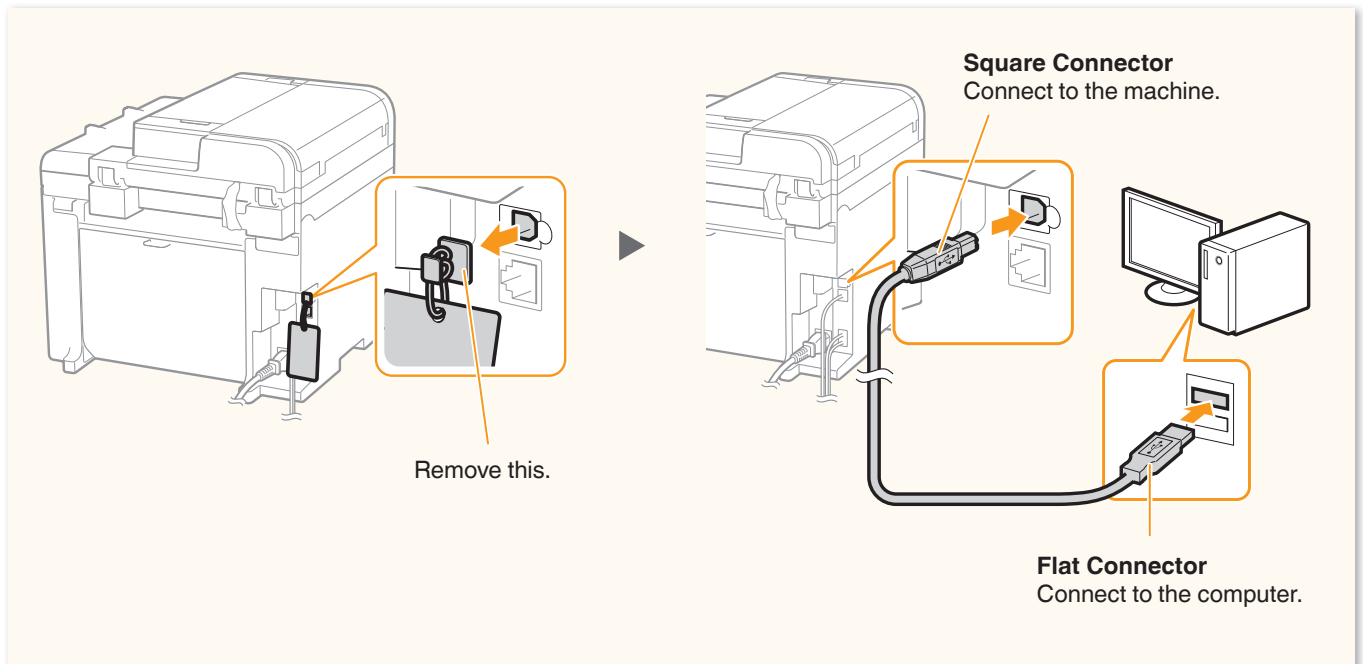

Computer connection via the USB is now complete.

➔ Proceed to P.24 to configure the fax.

1

USB Connection

Install the software. Macintosh



Install the MF drivers for Macintosh. It requires Mac OS X 10.5.8 version or later. The installation screen varies depending on the version of Mac OS X.

This operation is for Macintosh. If using Windows, proceed to P.19

Do not connect the USB cable yet.

Connect the USB cable after installing the MF Drivers and the MF Toolbox.

If you already connected the USB cable:

① Disconnect the USB cable from the computer, ② and then proceed to step ①.

1

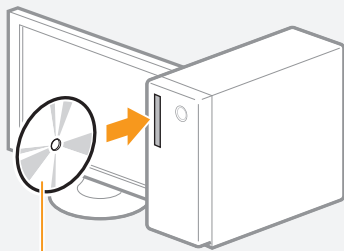

Insert the User Software CD-ROM and double-click the CD-ROM icon.

2



Follow the instructions on the screen to continue.

3

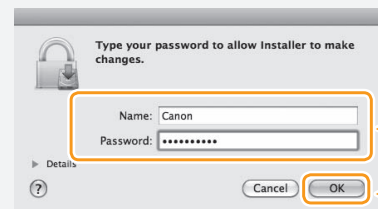

- Depending on the system environment, the dialog box may not be displayed. In this case, proceed to next step.

4

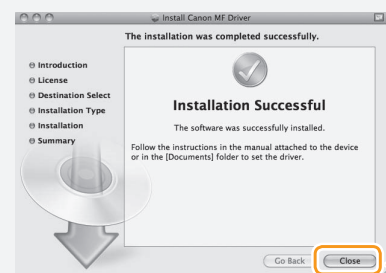

- Installing the drivers is now complete. Continued with registration operations on the desktop.

Connecting to the Computer

2 **USB Connection** **Connect the USB cable. Macintosh**



After installing the software, such as MF Driver, connect the USB cable. Make sure the software is installed first.

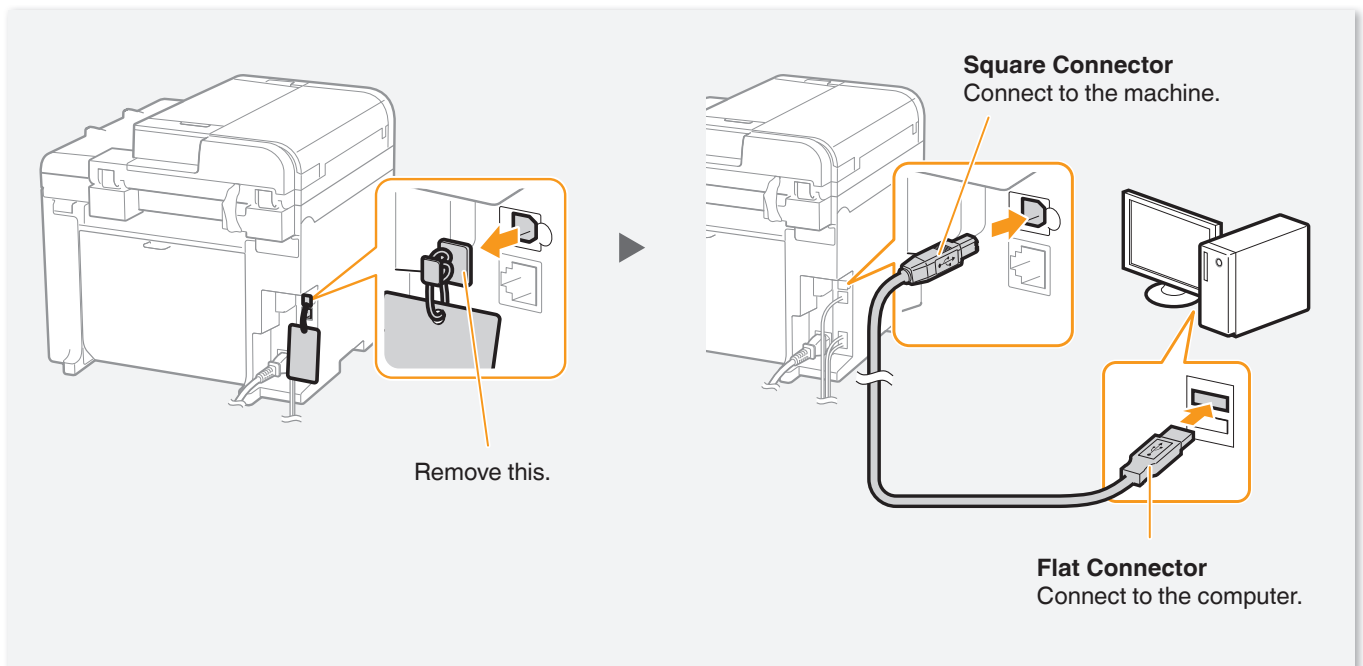

Computer connection via the USB is now complete.

➔ Proceed to P.24 to configure the fax.

Configuring the Fax

Set Up 1 Register the Fax Number and Unit Name



Perform fax setup?

Set up Now
Set up Later

- If you select <Set up Later>, the receive mode will be set to <Auto>.
- To reconfigure the settings, select [Menu] → <Fax TX Settings> → <Fax Setup Guide>.

OK

Register the unit telephone number for this machine.
*Next Screen: Press OK

OK

Register Unit Tel. No.

☎= 031234567

<Apply>
+

- Enter the telephone number using the numeric keys.

Register Unit Tel. No.

☎= 031234567

<Apply>
+

- Press [▲] or [▼] to highlight <Apply>, and then press [OK].

Register unit name.
(Sender name, company name, etc.)
*Next Screen: Press OK

OK

Register Unit Name

ABC

<Apply>
Entry Mode: A

- By referring to "Entering Text" (P.35), enter the unit name.

OK

Register Unit Name

ABC

<Apply>
Entry Mode: A

- Press [▲] or [▼] to highlight <Apply>, and then press [OK].

Set the RX mode.
Answer the following questions to select the appropriate mode.
*Next Screen: Press OK

- Do not operate the machine when this screen appears and proceed to the next page.

Registered information will be printed on the recipient's paper.

The fax number and unit name registered here will be printed on the recipient's paper as the sender information.

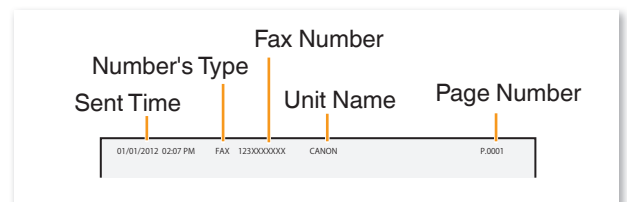

Check! Receive Mode That Fits Your Purpose

Choose a receive mode that meets your purpose from the following receive modes. The receive mode will be used to configure the setting in "Selecting the Fax Receive Mode" (P.26).



Fax

Use for Fax Only/No Voice Calls

You can use only for fax and may not use for voice calls. You do not need to connect the external telephone.

Receive Mode ⇒ Auto

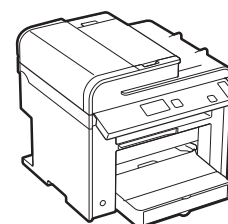

Phone

Mainly Use for Voice Calls/Almost Not Use for Fax

Connect an external phone to receive calls. Press [] (FAX), select <Start Receiving>, and then hang up the handset to receive faxes.

Receive Mode ⇒ Manual

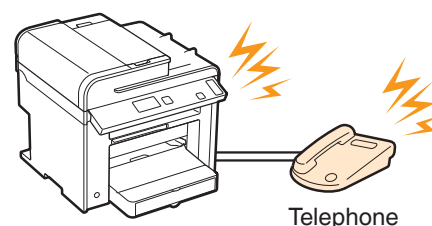

Telephone

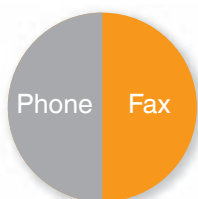

Phone Fax

Use for Fax and Voice Call

1 Using an answering machine

Connect an external answering machine to record voice messages when you are out, as well as receive calls. Faxes will be automatically received.

Receive Mode ⇒ Answering Machine

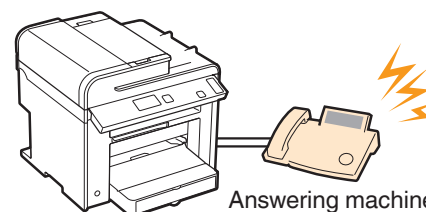

Answering machine

2 Using a General Telephone

Connect the external telephone. Faxes will be automatically received and the machine will ring when voice calls come in.

Receive Mode ⇒ Fax/Tel Auto Switch

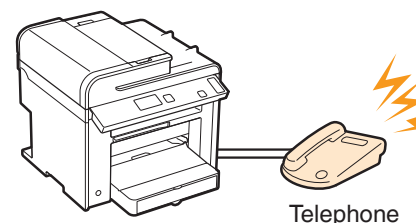

Telephone

Configuring the Fax

Set Up 2 Selecting the Fax Receive Mode

Set the receive mode that you confirmed in "Receive Mode That Fits Your Purpose" (P.25).

Set the RX mode.
Answer the following questions to select the appropriate mode.
*Next Screen: Press OK

OK ▼

Do you want to use this machine for fax only (no telephone)?

Yes
No

- To set to Auto mode → <Yes>
- To set to other receive modes → <No>

No ▼

Do you want to auto-receive faxes and answer phone manually?

Yes
No

- To set to Fax/Tel Auto Switch mode → <Yes>
- To set to other receive modes → <No>

No ▼

Do you want to use an answering machine to answer the phone?

Yes
No

- To set to Answering Machine mode → <Yes>
- To set to Manual mode → <No>

<Auto>

Yes ▶

<Fax/Tel>

Yes ▶

<Answer>

Yes ▶

<Manual>

No

RX Mode Settings
RX Mode: **XXXXXX** < Check!

*Reset: Press Back
*Apply: Press OK

OK ▼

Connect phone line.
Follow illustrations on the next screen:
Connect line to A.
*Next : Press OK

Connect phone line.
Follow illustrations on the next screen to make connections:
1. Phone line to A

The screen that appears varies depending on the receive mode selected.

When connecting a telephone with fax functions:
Set the fax receive mode of the telephone to "manual."

Set Up 3 Connecting the Telephone Line

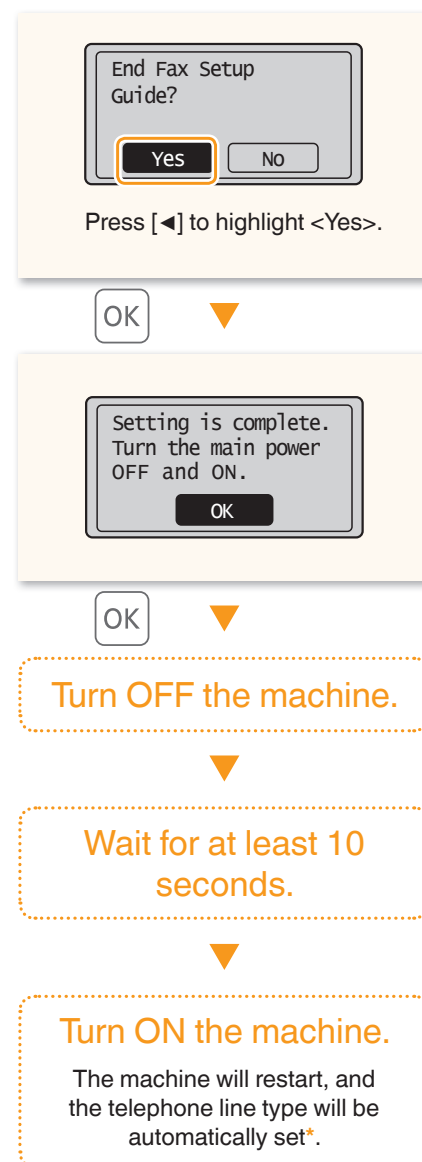
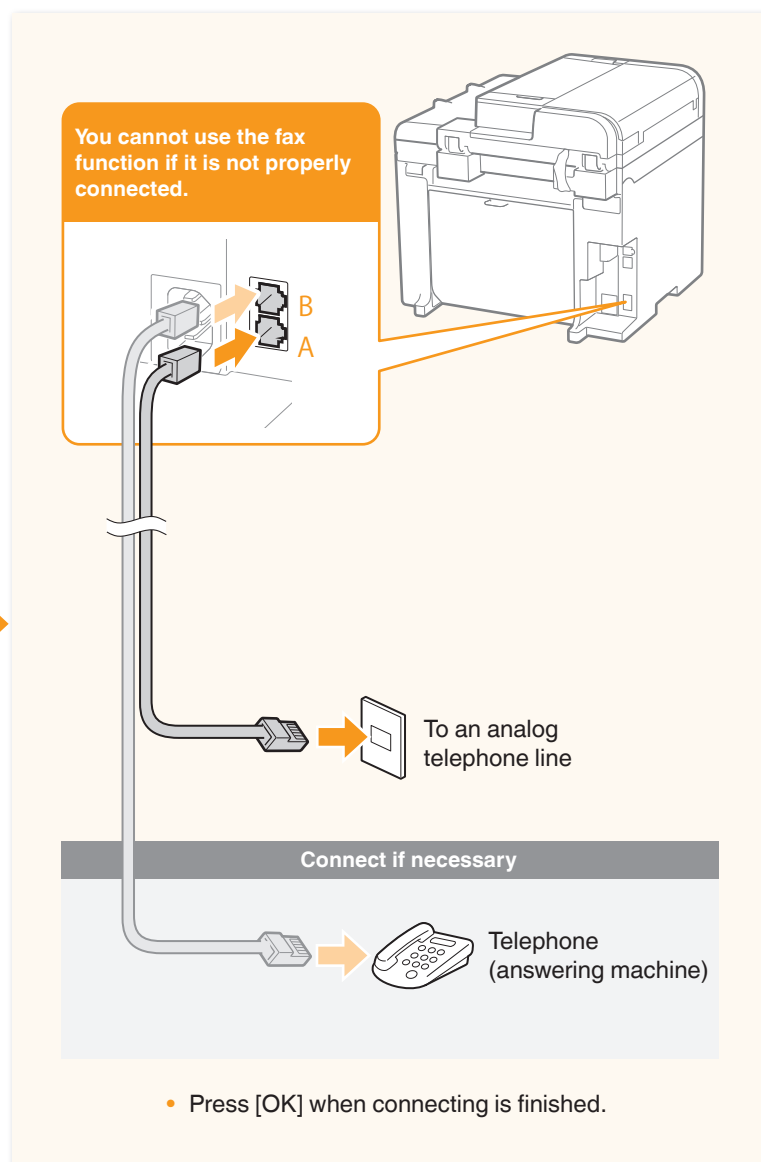

* If the telephone line type is not automatically set:

See the Basic Operation Guide to set manually.

➡ “Fax” → “Change the Fax Settings” → “Changing Fax Sending Settings” in the Basic Operation Guide

Appendix

Checking the IP Address

You can check the IP address of the machine. Use it when you need to enter the IP address during the configuration or registration.

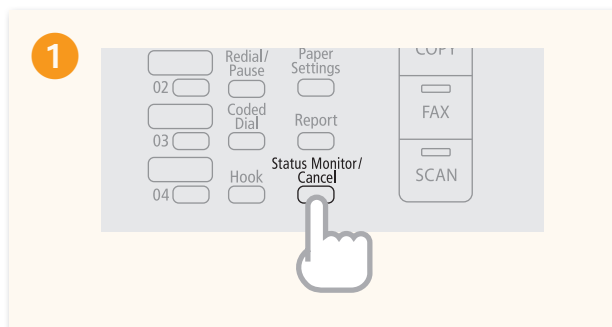

OK

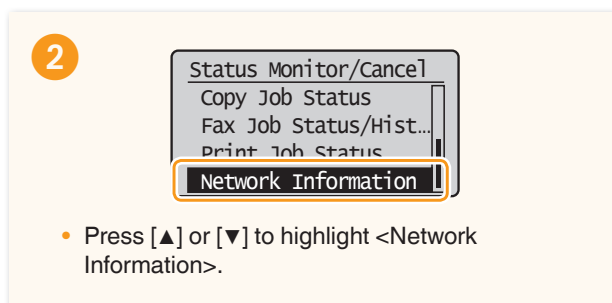

OK

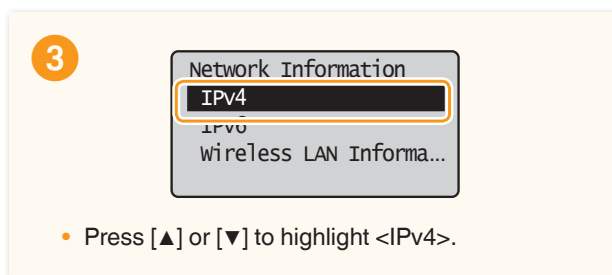

OK

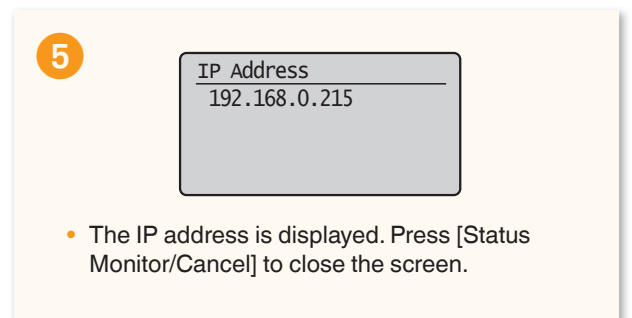
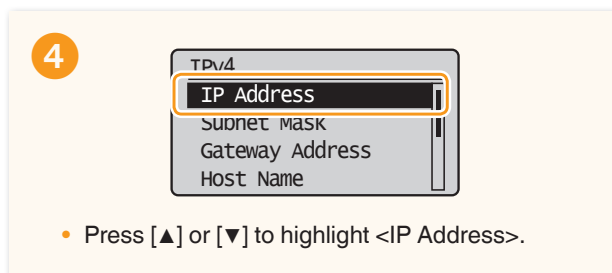

Check if the Machine Is Connected to the Network Correctly

“Start the web browser of the computer that is connected to the network, enter [<http://IP address of the machine>], and then press [ENTER]. (Example: <http://192.168.0.215/>)”

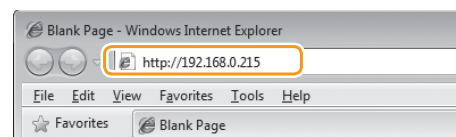

The screen below (Remote UI) should be displayed.*

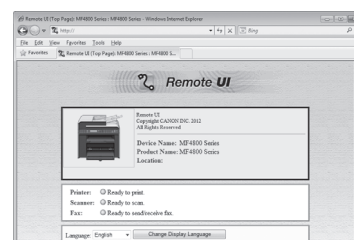

* If the remote UI screen is not displayed, see the e-Manual.

Loading Paper Other than Letter Size

To load paper other than Letter size, such as Legal or Statement, see “Loading Paper” (P.8) and the following procedure after finishing the initial settings.

1

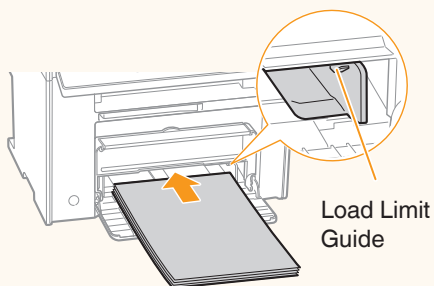

- Load the paper into the paper cassette.
- Make sure that the paper stack does not exceed the load limit guides.

2

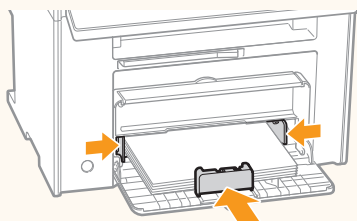

- Adjust the paper guides tightly to the width and length of the paper.

3

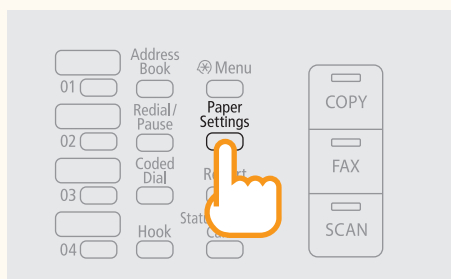

4

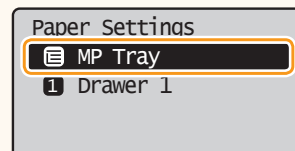

- Press [▲] or [▼] to highlight the paper source to load paper, and then press [OK].

OK

5

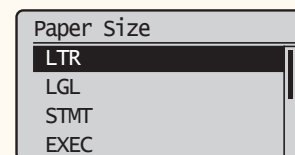

- Press [▲] or [▼] to highlight a paper size, and then press [OK].

OK

6

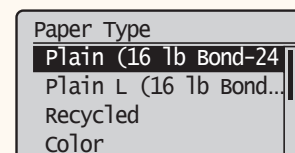

- Press [▲] or [▼] to highlight a paper type, and then press [OK].

Loading Paper that Is Longer than the Length of the Paper Cassette

Lift the dust cover extension after loading paper.

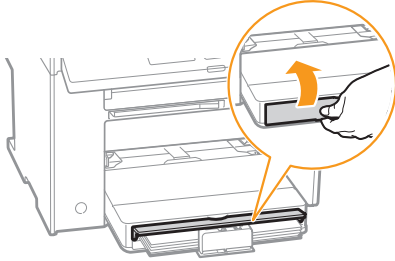

Loading Envelopes or Paper with a Letterhead

➤ “Loading Envelopes or Paper with a Letterhead” in the Basic Operation Guide.

Using the e-Manual

The e-Manual is an electronic manual document that is displayed on the computer. All features of the machine are categorized by subject, and you can quickly view the information you need by using its search function. Use the e-Manual as a reference.

Click to refer to the contents, glossary, and how to use the e-Manual.

Enter a keyword that you want to search to quickly find the information.

Click to view precautions when using Macintosh.

Click a button to access the information that you want.

Click when performing troubleshooting or maintenance of the machine.

Using the Online Help

Information, such as driver software information, is included in the online help. When using the driver software, you can immediately view the description of the features and the contents of the settings.

- 1 Select [File] → [Print] from the menu bar of an application.
- 2 Select the printer in [Select Printer] or [Name] in the [Print] dialog box.
- 3 Click [Preferences] or [Properties].
- 4 Click [Help].

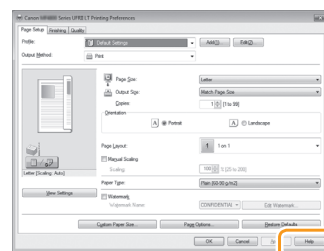

Windows

Installing in a Windows Environment

- 1 Insert the User Software CD-ROM in your computer.
- 2 Click [Custom Installation]*.
- 3 Click [Next].
- 4 Select only the [Manuals] check box.
- 5 Click [Install].
- 6 Click [Yes].
- 7 Click [Next].
- 8 Click [Exit] to finish the installation.

* If the CD-ROM setup screen does not appear:

- Windows XP/Server 2003
[Start] Menu → [Run] → enter [D:\MInst.exe**] → [OK]
- Windows Vista/7/Server 2008
[Start] Menu → [Search programs and files] (or [Start Search]) → enter [D:\MInst.exe**] → press the [ENTER] key

** The CD-ROM drive name is indicated as "D:" in this manual.

Displaying the e-Manual



Double-click the shortcut icon [MF4800 Series e-Manual] or [MF4700 Series e-Manual] on the desktop.

Displaying the e-Manual from the CD-ROM

Insert the User Software CD-ROM in your computer, click [Display Manuals], and then click  for [e-Manual].

※ Depending on the operating system, a message will be displayed for security protection to display the content.

Macintosh

Installing in a Macintosh Environment

- 1 Insert the User Software CD-ROM in your computer.
- 2 Open the [Documents] folder.
- 3 Drag and drop the [MF Guide] folder into a location where you want to save it.
- 4 When displaying the installed e-Manual, double-click [index.html] in the saved [MF Guide] folder.

Displaying the e-Manual from the CD-ROM

Double-click [index.html] in the saved [MF Guide] folder.

For Details About the Fax, Print, and Scan Functions

- Canon MF Printer Driver Installation Guide
User Software CD-ROM → [Documents] → [Print] → [Guide] → [index.html]
- Canon Fax Driver Installation Guide
User Software CD-ROM → [Documents] → [FAX] → [Guide] → [index.html]
- Canon Scanner Driver Guide
User Software CD-ROM → [Documents] → [Scan] → [Guide] → [index.html]

Memo

Disclaimers

The information in this document is subject to change without notice. CANON INC. MAKES NO WARRANTY OF ANY KIND WITH REGARD TO THIS MATERIAL, EITHER EXPRESS OR IMPLIED, EXCEPT AS PROVIDED HEREIN, INCLUDING WITHOUT LIMITATION, THEREOF, WARRANTIES AS TO MARKETABILITY, MERCHANTABILITY, FITNESS FOR A PARTICULAR PURPOSE OF USE OR NON-INFRINGEMENT. CANON INC. SHALL NOT BE LIABLE FOR ANY DIRECT, INCIDENTAL, OR CONSEQUENTIAL DAMAGES OF ANY NATURE, OR LOSSES OR EXPENSES RESULTING FROM THE USE OF THIS MATERIAL.

Trademarks

Canon, the Canon logo, and imageCLASS are registered trademarks of Canon Inc. in the United States and may also be trademarks or registered trademarks in other countries.

Apple, Mac OS, and Macintosh are trademarks or registered trademarks of Apple Inc. in the U.S. and/or other countries. Microsoft, Windows, Windows Vista and Windows Server are either registered trademarks or trademarks of Microsoft Corporation in the United States and/or other countries. All other product and brand names are registered trademarks, trademarks or service marks of their respective owners.

Copyright

© CANON INC. 2012 All Rights Reserved

No part of this publication may be reproduced, transmitted, transcribed, stored in a retrieval system, or translated into any language or computer language in any form or by any means, electronic, mechanical, magnetic, optical, chemical, manual, or otherwise, without the prior written permission of Canon Inc.

Entering Text

During the setup or initial configuration, you may need to enter letters and numbers. Use [▲], [▼], [◀], [▶], numeric keys, and [OK] to enter text.

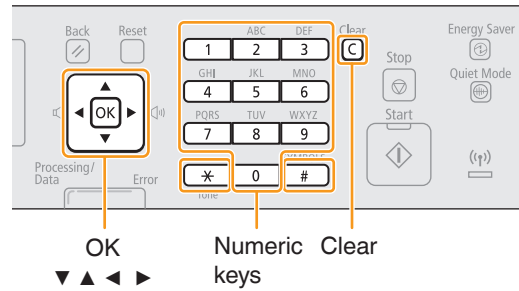

Numeric Key	Entry Mode (See below on how to change the Entry mode)		
	<A>	<a>	<12>
1	@.-_ /		1
2	ABC	abc	2
3	DEF	def	3
4	GHI	ghi	4
5	JKL	jkl	5
6	MNO	mno	6
7	PQRS	pqrs	7
8	TUV	tuv	8
9	WXYZ	wxyz	9
0	(Not available)		0
#	-. * # ! " , ; : ^ ` _ = / ' ? \$ @ % & + \ () [] { } < >		(Not available)

Changing the Entry Mode

The machine supports three entry modes: <A> for uppercase, <a> for lowercase, and <12> for numbers. The default setting is <A>. Press [▼] to highlight <Entry Mode: A>, and then press [*] (Tone) to switch between the entry modes.

Moving the Cursor

Press [◀] or [▶] to move the cursor.

Entering a Space

Move the cursor to the end of the text, and then press [▶].

Deleting Characters

Press [C] (Clear) to delete characters. Press and hold to delete all characters.

Contacting the Service Center

When you have a problem with your machine, refer to "Troubleshooting" in the Basic Operation Guide or the e-Manual first. If you cannot solve the problem after referring the manuals, contact the Canon Authorized Service Facilities or the Canon Customer Care Center.

Canon Customer Care Center

1-800-OK-CANON

(U.S.A./Canada)

U.S.A

Monday through Friday

From 8:00 A.M. to 8:00 P.M. EST

Canada

Monday through Friday

From 9:00 A.M. to 8:00 P.M. EST

<http://www.canon.ca/>

Canon

CANON INC.

30-2, Shimomaruko 3-chome, Ohta-ku, Tokyo 146-8501, Japan

CANON MARKETING JAPAN INC.

16-6, Konan 2-chome, Minato-ku, Tokyo 108-8011, Japan

CANON U.S.A., INC.

One Canon Plaza, Lake Success, NY 11042, U.S.A.

CANON EUROPE N.V.

Bovenkerkerweg, 59-61, 1185 XB Amstelveen, The Netherlands

CANON CHINA CO. LTD.

15F Jinbao Building No.89, Jinbao Street, Dongcheng District, Beijing 100005, PRC

CANON SINGAPORE PTE LTD

1 HarbourFront Avenue, #04-01 Keppel Bay Tower, Singapore 098632

CANON AUSTRALIA PTY LTD

1 Thomas Holt Drive, North Ryde, Sydney NSW 2113, Australia

CANON GLOBAL WORLDWIDE SITES

<http://www.canon.com/>



FT6-0295 (000)

XXXXXXXXXX

© CANON INC. 2012

PRINTED IN KOREA



F T 6 - 0 2 9 5 - 0 0 0