

SHARP

MX-M565N
MX-M465N
MX-M365N

Digital Multifunctional System

Advanced MFP Leads the Way
in Productivity and Eco-Friendly Operation



COPY

NETWORK PRINT

NETWORK
COLOUR SCAN

FAX
OPTION

An Environment-Friendly Way to Greater Productivity and Intuitive Operation

Thanks to a 10.1-inch multi-touch-capable colour LCD touchscreen, the MX-M565N/M465N/M365N—a B/W MFP with full-colour network scanning—offers effortless navigation and intuitive ease of use. For smooth document feeding and enhanced efficiency, the MX-M565N/M465N/M365N boasts a high-speed Duplex Single Pass Feeder. Other advanced functions include a wide selection of finishing options for attractive document finishing, standard-equipped security functions for total peace of mind, and handy mobile access for on-the-go productivity.

And what makes all of these features even more appealing? That's easy—Sharp designed the MX-M565N/M465N/M365N with outstanding energy efficiency and true environmental friendliness in mind.



Enhanced Intuitive Operation

Simple hand gestures and a 10.1-inch colour LCD touchscreen let even first-time users navigate the MX-M565N/M465N/M365N with ease. Thanks to multi-touch operation, two-finger pinch and spread gestures facilitate Web browsing and make it easy to shrink and enlarge images in Advanced Preview. Equally easy one-touch commands, such as flick, drag, and tap, provide quick onscreen access to MFP functions and ultra-smooth intuitive operation.



* Shown above are colour previews for Scan to E-mail. Copy previews are in B/W.

Eco Friendliness

The MX-M565N/M465N/M365N gets its eco edge from advanced environmental technologies incorporated throughout the MFP—from its hardware and electrical system down to its software and supplies. Even its short warm-up time of 12 seconds produces substantial energy savings.

The new Mycrotoner-CAP is one of those eco-boosting supplies. The low melting point of this proprietary toner lets it get the job done with less energy than conventional toner requires.

And this dramatically reduced power consumption is what gives the MX-M565N/M465N/M365N one of the lowest TEC values** in the industry—significantly lower than even the maximum values allowable under ENERGY STAR®.



Lower TEC Value

Model	Energy Savings (%)	TEC Value (kWh)*3	Max. allowable TEC value*2
MX-M565N	56.5%	3.5 kWh*3	6.2 kWh
MX-M465N	61.9%	2.6 kWh*3	4.2 kWh
MX-M365N	67.7%	2.1 kWh*3	3.1 kWh

Shorter Warm-Up Time*4

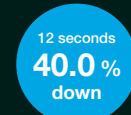

*1 Typical amount of energy consumed in a hypothetical week measured as stipulated under the ENERGY STAR® programme.

*2 Maximum TEC value allowable under the latest ENERGY STAR programme (version 2.0).

*3 Measured at 230V. TEC values are as follows when measured at 100V (models for the Japanese market): MX-M565FN: 3.3 kWh, MX-M465FN: 2.5 kWh, MX-M365FN: 1.9 kWh

*4 Compared to MX-M503N/M453N/M363N (warm-up time 20 seconds).

Productive Performance

Leading the way to document productivity is a 150-sheet high-speed DSPF (duplex single pass feeder) that gives the MX-M565N/M465N/M365N quick scanning speeds of up to 85 opm for one-sided originals and 170 opm for two-sided originals—in both colour and B/W. For added convenience, an optional 500 + 2,000-sheet paper drawer increases the MX-M565N/M465N/M365N's total paper capacity to 6,600 sheets. And a variety of finishing options, including a 4,000-sheet A3 saddle stitch finisher, makes for attractive and efficient document finishing.





COPYING & NETWORK PRINTING

PRODUCTIVE

Super-Efficient Output



The MX-M565N/M465N/M365N delivers a fast output of **56*/146/36 cpm/ppm*2**. And the first copy comes out in just **3.7/3.9/4.5 seconds** to save valuable time when performing multiple short-run jobs.

*1: 51 cpm/ppm for MX-M565N when equipped with MX-FN10.
*2: A4 (8 1/2" x 11"), long-edge feeding



Speedy Document Feeding



The MX-M565N/M465N/M365N comes standard with a highly efficient **150-sheet DSPF** (duplex single pass feeder), which **scans both pages** of two-sided documents **up to A3** (11" x 17") in size in one pass. Doing away with the reversing circuit minimises paper misfeeds and vastly improves reliability. With a scanning speed of up to **85 opm*** (one-sided) or **170 opm*** (two-sided), the MX-M565N/M465N/M365N finishes even large projects quickly.

* Originals per minute; when feeding A4 (8 1/2" x 11") sheets

Built-In Stackless Duplex Module



The MX-M565N/M465N/M365N can make **two-sided copies and printouts** using its built-in stackless duplex module, effectively reducing paper costs as well as saving filing space.

Automated Finishing



The MX-M565N/M465N/M365N offers plenty of finishing options to suit a variety of workplaces and applications. For basic sorting/stapling of documents of up to 50 sheets, two types of handy finishers are available: the **space-efficient Finisher** can be added on without taking up much room, while the **large-capacity Finisher** has output trays that can hold up to 4,000 sheets. **Saddle Stitch Finishers** also come in two types: one has an output tray capacity of up to 1,000 sheets, while the other boasts a capacity of up to 4,000 sheets. In addition to basic sorting/stapling, both types of Saddle Stitch Finishers can fold/staple documents of up to 15 sheets to make completed booklets. **Punch Modules**, which punch holes in documents for easy filing, are available for each finisher.



Space-efficient Finisher



1,000-sheet Saddle Stitch Finisher



4,000-sheet Saddle Stitch Finisher

Extra Paper Capacity



For high-volume work, the MX-M565N/M465N/M365N can accommodate an optional **stand with 500 + 2,000-sheet paper drawer** for a total capacity of **6,600 sheets**. When a tray runs out of paper, the **Auto Tray Switching** function automatically switches to another paper tray filled with the same size paper, allowing you to do extra-large volume jobs without worry.



A Range of Copy/Print Applications

Multi Shot and Booklet Making



Thanks to Multi Shot, two to eight pages of a multi-page document can be copied and up to 16 pages can be printed onto a single sheet, reducing paper use. And with the optional Saddle Stitch Finisher, multiple sheets can be automatically centre-stapled together to make booklets.

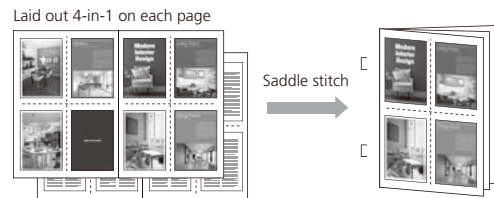

Custom Images



Customised images prepared by the user, such as a company logo stamp or a "TOP SECRET" watermark, can be used on copies.



Stamp



Watermark

Book Divide



When copying or scanning a booklet or book, the Book Divide function separates the right and left (or the top and bottom) of a two-page spread and outputs each page in the original page order.

Image Positioning



With this function, a scanned image, such as a photo or an illustration, can be copied onto another document in a position specified by the user. The output can be confirmed beforehand using the Advanced Preview function on the LCD.

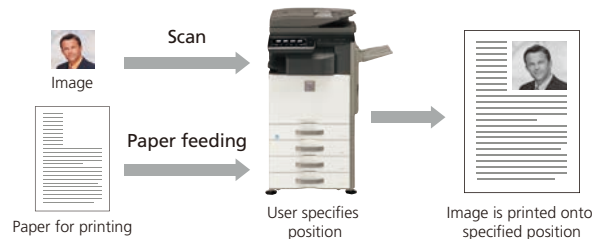

Long-Paper (Banner) Printing*



The optional **Long Paper Feeding Tray** accommodates extra-long paper up to **1,200 mm**—expanding the range of print products to include panoramic pictures, large display-window ads, banner signs, and more.

* Contact a Sharp customer representative for details on using this function.



(Image)

Supports Most Office Environments



The MX-M565N/M465N/M365N works with the latest and most commonly used versions of Windows®, Windows Server®, and Mac operating systems and network protocols—including **IPv6**—even in mixed OS environments. You get fast, powerful network printing via the 1000Base-T **Gigabit Ethernet** standard.

SUPERB IMAGE QUALITY

High-Resolution Output



The MX-M565N/M465N/M365N delivers 600-dpi copying and razor-sharp **1,200-dpi** printing—without sacrificing output speed. Digital smoothing technology enhances the print and copy resolution to the equivalent of **9,600 x 600 dpi** for incredibly smooth reproduction of fine lines. Fine-grained photographs, detailed illustrations and graphs, and small text come out crisp and clear.

Stable Halftones and Smooth Gradations



Halftone process control employs an image density sensor to enhance the stability and accuracy of halftones, thereby bringing consistently high image quality to copy/print jobs. Meanwhile, 4-bit depth, rated at 600 dpi resolution, generates fine dots and rich greyscales that provide smooth gradations.

Standard PCL 6 and True Adobe® PostScript® 3™



For improved graphics handling and enhanced font compatibility, the MX-M565N/M465N/M365N comes standard with both PCL 6 and true Adobe PostScript 3.

Enhanced Scan Performance



A function of Auto Colour Mode, the automatic suppression of unnecessary background colour is essential to achieving crisp, clear, natural-looking images. The MX-M565N/M465N/M365N provides enhanced background suppression without losing colour balance, resulting in scanned images that closely match the original.

Auto Colour Mode

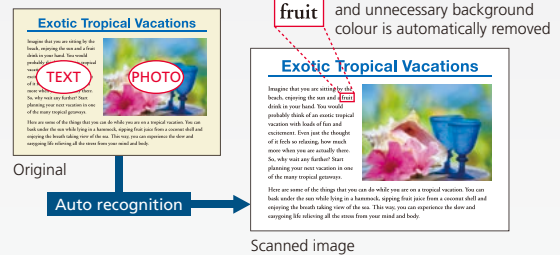

VERSATILE OPERATION

Direct Printing



The MX-M565N/M465N/M365N can print PDF, TIFF, JPEG, XPS*, and other files without using the printer driver. And there's a USB port beneath its control panel, which comes in handy when printing data directly from USB memory devices—an indispensable function for users who are in a hurry or who want quick machine access without a PC.

* Direct XPS printing requires optional MX-PUX1 and 1GB of extra memory.



Simultaneous Job Processing



The MX-M565N/M465N/M365N makes it easy to simultaneously carry out multiple jobs. Scanned documents can be copied and e-mailed at the same time. And documents can be simultaneously printed and faxed for ultra-convenient multitasking.

Skip Blank Page Function



When copying, printing, or scanning* a multi-page document, the MX-M565N/M465N/M365N recognises and skips any pages without content. It can do the same when printing directly via the Document Filing function or from a network folder (SMB), FTP server, or USB memory device, helping to save paper.

* Not including fax or Internet fax.

Other Key Features

Heavy-Paper Handling*



The MX-M565N/M465N/M365N can handle heavy paper up to **300 g/m²**, further expanding the range of printing applications.

* Paper must be fed through multi-bypass tray. Depending on usage conditions and type of paper, printing may not be executed correctly.

Repeat Layout



Upgraded from the conventional Photo Repeat function, this function can repeat an entire page layout as a single image onto a single sheet.

Auto Zoom for Irregular-Size Originals



With Auto Zoom, after the user specifies the required finished size of a copy, the MFP will automatically calculate the appropriate ratio by which to reduce or enlarge an irregular-size original.

Layout Print



This function repeats an entire page layout as a single image. The user can specify whether or not to repeat the first page (cover page) of the document.

- **Tab Copy / Tab Print** can copy or print directly onto tabs on document separators and insert them into assigned positions.
- **Multi-Page Enlargement** divides an image onto separate sheets for copying/printing posters.
- **Carbon Copy Print** mode automatically outputs multiple printouts of the same data on plain and/or coloured paper; convenient for invoices and purchase orders.
- **Form Overlay** can store office document formatting such as letterheads and overlay contents, eliminating the need for pre-printed paper. (PostScript driver only)
- **Barcode font** compatibility (requires optional MX-PF10)
- **Card Shot** enables easy copying of both sides of a card (credit cards, ID cards, etc.) onto a single page.
- **Book Copy** is convenient for compiling copies of a book or bound originals into pamphlet format.



IMAGE SENDING

: Scan : Fax

A3 Colour Network Scanning

The MX-M565N/M465N/M365N works as a **full-colour network scanner** and supports TIFF, PDF, encrypted PDF, compact PDF*, PDF/A, JPEG, and XPS file formats. Scanned documents can be converted into **compact PDF** files to enable fast, high-volume transmission and save storage space. Enhanced scan performance improves the legibility of extremely fine text and allows vivid colour reproduction in scanned documents. **Auto Colour Selection** chooses the right mode for scanning originals containing both colour and B/W pages. And five levels of sharpness and contrast control enable finely tuned adjustments for optimal image quality.

* Requires optional MX-EB11.

Multiple Distribution of Scanned Files

With just a few taps on the LCD touchscreen, you can choose different ways to distribute your scanned documents. **Scan to E-mail** sends documents as an e-mail attachment. **Scan to FTP Server** scans documents directly to an FTP server for storage. **Scan to Desktop** sends scanned documents directly to your PC desktop. **Scan to Network Folder (SMB)** sends files to a shared folder on a networked Windows-based PC. **Scan to External Memory Device** scans documents directly to USB memory devices. And **Scan to Fax** enables conventional faxing or Internet faxing.

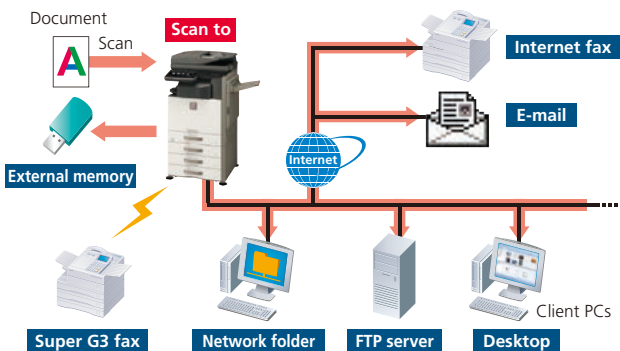

Home Directory

The Home Directory function with user authentication allows users to designate a network folder as their own default scan destination, enabling easy data transfer. In addition to simplifying the scanning process, this handy function lets users scan and send large files that exceed the capacity of mail servers. It's so simple: after a user has logged on via user authentication and gone to the Image Send screen, the Home Directory function automatically selects the scan-destination folder.

Auto File Division

To e-mail a large multi-page data file that exceeds the file transmission capacity, simply set the MFP to automatically split that file into several separate files. The separated files will be e-mailed out individually, the e-mail messages will be automatically titled, and the attached data files will be automatically named.

Note: Depending on the number of pages and the file transmission capacity, this function may not work on some data files.

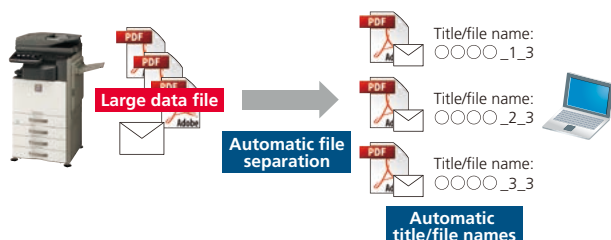

LDAP Support

Built-in LDAP (lightweight directory access protocol) support eliminates the need to enter or register full addresses. When you enter the first few letters of the recipient's name, the MFP displays a list of possible matches from your company's LDAP server. Selected addresses can be stored to the MFP's address book.

Drop Out Colour

This function removes chromatic colour from a scanned image, reducing the data size for compact storage and enhancing the legibility of B/W text to improve the text recognition rate before OCR.

One Scan/Multi Format

This function allows you to specify image resolution or colour for each mode of broadcasting employed. For example, when sending the same image data to both a fax and an e-mail destination, you can send a B/W version via fax and a full-colour version via e-mail.

High-Speed Faxing

The optional MX-FX11 Fax Expansion Kit turns the MX-M565N/M465N/M365N into a 33.6 Kbps **Super G3 fax** machine. Quick On-Line Transmission initiates dialling and transmitting as soon as a page is scanned into memory. JBIG compression technology lets the MFP send an A4 (8 1/2" x 11") size page in under three seconds*.

* Based on Sharp's standard chart with approximately 700 characters (A4 or 8 1/2" x 11" long-edge feeding) at standard resolution.

PC-Fax/PC-Internet Fax

Directly send a document created on your PC to a recipient's fax machine via a phone line or the Internet without printing to paper. Save time and paper costs while retaining original document quality. Note: PC-Internet Fax requires optional MX-FWX1; PC-Fax requires MX-FX11.

Internet Fax

Economically send and receive faxes to and from other T-37-compliant Internet fax machines via the Internet. Thanks to **Direct SMTP** support, outgoing Internet faxes do not go through your mail server, making transmission faster and cheaper.

Note: Requires optional MX-FWX1.

Paperless Faxing with Inbound Routing

Paperless faxing with inbound routing lets you check incoming faxes via e-mail before printing them out. It can also forward incoming faxes to destinations—another fax/Internet fax machine, an FTP server, a network folder (SMB), or a PC desktop—specified for each sender. When fax data is transferred by file, the Inbound Routing function automatically attaches the fax sender's name (as registered in the MFP's address book) to the file, so recipients will know who sent the fax.

Note: Requires optional MX-FX11 and/or MX-FWX1.

Fax Data Storage on MFP Hard Disk

The MX-M565N/M465N/M365N automatically stores data from incoming and Internet faxes on its hard disk for easy confirmation and printing from a PC.

Note: Requires optional MX-FX11 and/or MX-FWX1.

DOCUMENT MANAGEMENT

Document Management on the Hard Disk

You can save processed job data in designated folders on the MFP's hard disk, making it easy to instantly recall saved documents or jobs for printing and sending at a later time. This contributes greatly to efficient sharing and distribution of information in your business operations.

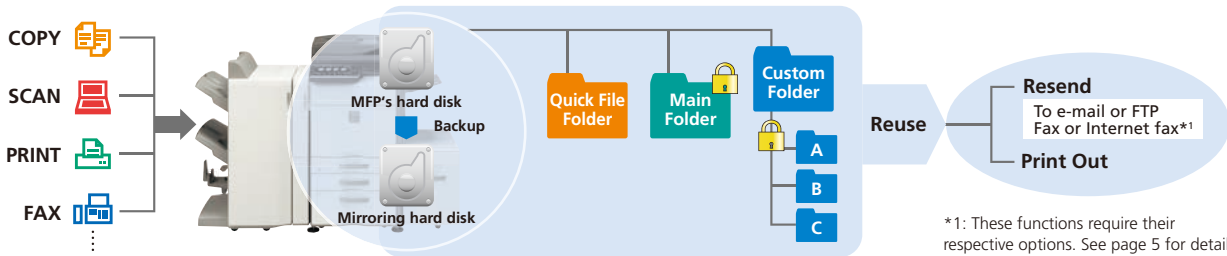

*1: These functions require their respective options. See page 5 for details.

Quick Filing

Up to **10,000 pages** or 1,000 files*² that have been copied, printed, scanned, or faxed*³ can be stored by job on the hard disk in a Quick File Folder. You can easily reuse saved data without having to reload or rescan the original.

Advanced Filing Function

Up to **20,000 pages** or 3,000 files*² that have been copied, printed, scanned, or faxed can be stored by job on the hard disk in up to 1,000 folders with customised names and locations. Enhanced security features require users to enter a 5- to 8-digit password to access secure folders, protecting your sensitive data. Storage options include Main Folder for workgroup sharing and Custom Folder for enhanced-security archiving.

*2: Storage capacity will vary depending on the type of document and the scan settings.

*3: For fax and Internet fax jobs, only transmitted data (not received faxes) can be saved in the Document Filing function.

Easy Access to Stored Files

Documents stored on the hard disk can be quickly and easily searched and accessed from the control panel's LCD via thumbnail displays and file previews or through a Web browser.

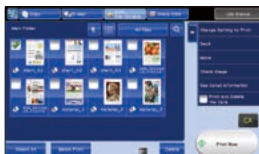

Thumbnail displays



Web access screen

File Combining

For more effective data utilisation, two files saved on the MFP's hard disk can be easily combined into one file.

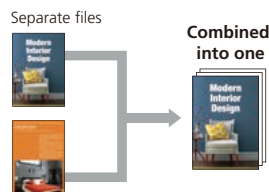

PDFs for PC Browsing

Processed job data can be saved as PDF files for browsing and downloading on a PC.

Easy Sharing of Application Files

To facilitate file sharing across the office network, the MX-M565N/M465N/M365N provides 120GB of hard disk storage space for folders. Each folder can hold up to 500 files created with applications such as Word and Excel® and saved in their original format.

Note: It is advisable to back up data saved to the MFP's hard disk through use of the optional Mirroring Kit.



Mirroring Kit

To protect the enhanced data handling capability of the MFP's hard disk, which provides improved Document Filing functions and easy sharing of application files, the optional Mirroring Kit offers hard disk backup and peace of mind.

Sharpdesk for Total Document Management

Sharpdesk is an original Sharp application that provides integrated desktop management of documents in over **200 file formats**, including scanned paper-based documents and those created with popular applications such as Word. With Sharpdesk, documents can be organised, edited, searched, and distributed with simple drag-and-drop operation. Features include **thumbnail** viewing, **annotation** tools for paper-free proofreading, optical character recognition, the ability to combine different types of files into a single document, and more.

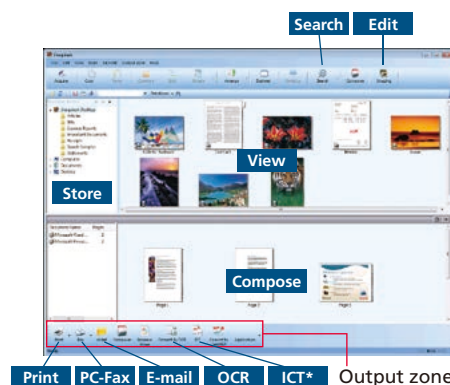

* Image Compression Tool for converting images into compact PDF files

MULTI-LAYERED SECURITY

Designed to protect your business assets and bring you peace of mind, Sharp's industry-leading security solutions employ multiple levels of security functions—both standard equipped and optional—covering a broad range of network and data security needs. The MX-M565N/M465N/M365N safeguards sensitive data with powerful, enhanced security functions that eliminate the worry of unauthorised use and guarantee greater protection for your confidential information.

Secure Network Access

The **IP/MAC address filtering** function provides highly secure operation by restricting access to the MFPs on your office network. Only PCs that have either their IP address or MAC (media access control) address registered are allowed to use the MFPs. Attempted access from an unknown IP or MAC address will be denied, preventing unauthorised use. The MX-M565N/M465N/M365N also supports the **IEEE 802.1X** standard for port-based network access control, which blocks all access from unauthorised devices.

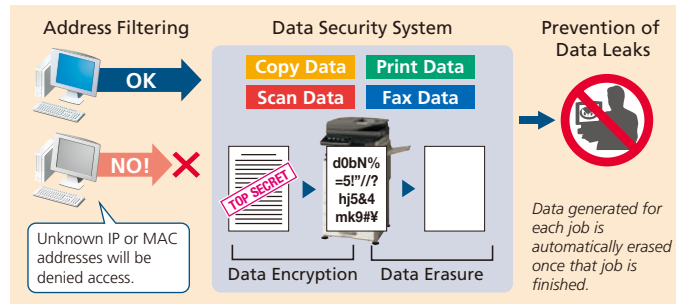

Data Encryption and Overwriting

Digital copier/printers and MFPs retain large amounts of data generated from copy/print/scan/fax jobs in internal storage. To safeguard confidential data from unauthorised access, standard-equipped security features on the MX-M565N/M465N/

M365N automatically **encrypt** job data prior to saving it to internal storage. Once a job is finished, that encrypted data is **erased** via up to seven automatic overwrites. **Protection** of administrator/file/folder passwords brings further peace of mind.

Note: Contact a Sharp customer representative for details on activating these security functions.

User Authentication

The MX-M565N/M465N/M365N prevents unauthorised use by requiring **passwords** for machine access. This safeguarded solution can register up to 1,000 users in **three access levels** as Administrator, User, or Guest and can designate to which function user authentication applies. And the MX-M565N/M465N/M365N works with an **external Active Directory server** to extend user authentication to multiple MFPs and a greater number of users.

Tracking Information Print

This function prints the MFP user's name, the date, the MFP's serial number, job ID, and other specifics on printouts, making it possible to track documents and prevent data theft.

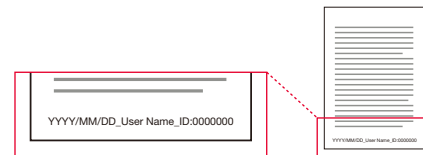

Encrypted PDF with Password Protection

To prevent unauthorised viewing of confidential data, the MX-M565N/M465N/M365N enables scanned PDF data to be password protected and encrypted for transmission over the network. After transmission, viewers can gain access to the encrypted PDF only after re-entering the password.

Document Control Function (option)

Document Control prevents unauthorised copying, scanning, faxing, and filing of confidential documents by embedding copy prevention data onto a document. When that data is detected, any unauthorised attempts to copy will be cancelled or will result in only blank-page output.

Note: Requires optional Data Security Kit. May not work for certain types of documents or paper.

SSL and IPsec Data Encryption

To ensure an extremely high level of network security, the MX-M565N/M465N/M365N employs **SSL** (secure sockets layer) and **IPsec** data encryption technologies. SSL encryption prevents data leakage through the network when printing via IPP, browsing secure Web pages (HTTPS), or communicating via e-mail (SMTP and POP3) or FTP (FTPS). IPsec encrypts and authenticates traffic between specified parties.

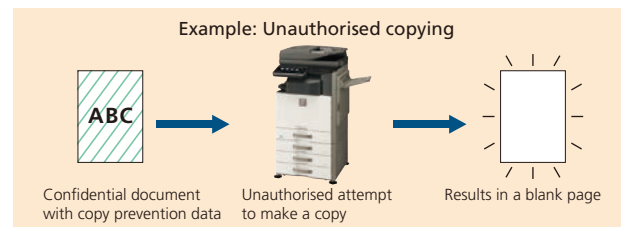

Hidden Pattern Copy/Print

With this function, a watermark, such as "Confidential" or "Not for Copy," can be embedded onto a document. If that document is copied, the watermark will appear, alerting the user not to distribute it.

Data Initialisation

The MX-M565N/M465N/M365N's initialisation function allows confidential information to be erased. Initialising an MFP when it's time to replace it prevents important resources, such as customer information and intellectual property, from leaking out and provides considerable peace of mind.



DEVICE MANAGEMENT

Web-Based System Settings

Administrators can manage every important setting—including user access and security as well as other controls and configurations—through a standard Web browser right from their desktops.

Remote Diagnosis

The MX-M565N/M465N/M365N can be monitored remotely through a Web browser, letting administrators handle tasks before they become problems. And when action or maintenance is required, the **E-Mail Status and Alert** function notifies administrators via timely e-mail alerts.

Network Utility Software

Sharp Remote Device Manager* (SRDM) gives administrators centralised control of their networked MFPs through a standard Web browser, making device cloning and other operations easier and more accessible.

* Contact a Sharp customer representative for availability and other details.

Remote Operation

The Remote Operation function lets you display the MFP's main control panel on your PC screen, allowing you to operate every major function directly from your desktop.* This function also enables the administrator to guide an MFP user through necessary procedures and allows remote MFP operation from a wheelchair.

* Requires VNC application.



EASE OF USE

10.1-Inch Colour LCD Touchscreen

MFP operation has never been so intuitive, so easy. The MX-M565N/M465N/M365N's control panel features a wide, clear, WSVGA-resolution LCD touchscreen. Simple gestures—flick, drag, tap, and more—performed on the screen bring easy control of every document, function, and setting. And dual-touch pinch and spread gestures enable smooth Web browsing and effortless shrinking/enlarging of Advanced Preview images. For strain-free viewing, the MFP's user interface employs a bold scalable font in sizes that vary in line with the content on display.

Mode Tabs

Mode tabs at the top of the screen make it easy to change job modes (copy, e-mail, document filing, Sharp OSA, etc.).



Customisable Screen

The Home screen can be customised for individual users by programming their most frequently used functions and settings, creating **shortcut keys** for quick and easy access, and using logos, icons, background images, and other items prepared by the user. The **Enlarge Display** mode brings added readability.



Advanced Preview

The Advanced Preview function saves you time and effort by displaying scanned images on the LCD for confirmation and editing. Page layout and document finishes such as stapling can be checked before the documents are printed out. Previewed pages can be easily rotated, put in a different order, and deleted via tap-and-drag editing right on the LCD. You can even erase specific parts of a previewed page and insert blank pages.

Action Panel

The Action Panel appears on the right side of the touchscreen to guide you through operational procedures. The MFP intuits what actions to take next and the Action Panel displays shortcut keys and messages pertaining to those actions.



Other User-Friendly Features

Universal Design

- The control panel can be **tilted** to five different angles* for easy viewing, even from a wheelchair.
 - * Number of tiltable angles depends on type of optional finisher installed.
- **Easy-grip handles** allow the paper drawers to be grasped from the top as well as the bottom for easy opening and closing.



Retractable Keyboard (option)

A **full-size retractable QWERTY keyboard** slides out from beneath the control panel to make text input fast and easy.



ENVIRONMENT-FRIENDLY

Outstanding Energy Efficiency

- Sharp's belt fusing system reduces energy consumption and as a result, shortens the MX-M565N/M465N/M365N's warm-up time to 12 seconds.
- **Eco Scan** function saves energy by keeping the fusing system shut down during jobs that don't require its use, such as Image Sending and Document Filing.
- Based on prior usage patterns, the MX-M565N/M465N/M365N automatically determines the optimal length of time to let elapse before going into **auto power shut-off mode**, helping reduce overall power consumption. And pressing the **power save key** after a job is finished immediately puts the MFP into auto power shut-off mode for further cutbacks on running costs.
- **Power ON/OFF Schedule** function automatically turns the MX-M565N/M465N/M365N on or off according to time schedules set by the administrator.

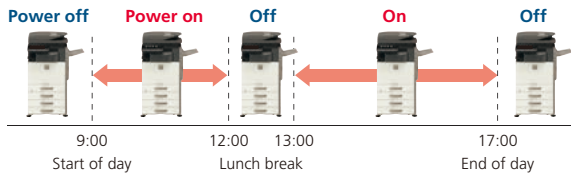

- Before a print*/copy command is executed from the control panel, the **Eco Recommendation** function offers suggestions on environmentally friendly settings, helping users achieve even greater eco-friendly operation.



- * For printing Document Filing data and direct printing (FTP/SMB/USB).
- Energy-efficient **LED lamps** employed in the scan unit (instead of conventional xenon lamps) provide further energy savings.

Eco-Friendly Supplies

- **Mycrostoner-CAP** toner particles are in capsule form, and each capsule is filled with low-melting-point material. That gives Mycrostoner-CAP a lower melting point than conventional toner and allows it to fuse at lower temperatures, resulting in reduced energy consumption and lower TEC values for the MFP.

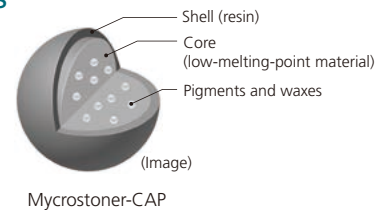

- Longer-life supplies (drum unit, developer, service parts) contribute to resource savings.

EXPANDABILITY

Sharp OSA* (Open Systems Architecture)

Innovative Sharp OSA technology allows you to interact with critical business and network applications right from the LCD control panel, offering a new realm of control and convenience. And since Sharp OSA utilises industry-standard network protocols, the MX-M565N/M465N/M365N can easily integrate with document management systems, enterprise resource planning software, workflow applications, and more. The latest version of Sharp OSA can **reach beyond the firewall**, enabling extensive system construction and services over the Internet. Sharp OSA brings benefits such as reducing the costs associated with system implementation and management, as well as enabling data sharing across company branch offices or subsidiaries—effectively enhancing total business efficiency.

* Requires optional MX-AMX2 and/or MX-AMX3.

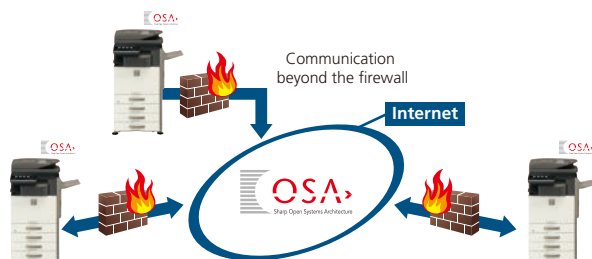

Direct Internet Access

The optional **Web Browsing Expansion Kit** gives you direct access to the Internet for easy browsing of Web sites on the colour touchscreen. With such quick access to information, brochures and user manuals in PDF format as well as maps and coupons can be printed out on the spot.

Sharpdesk Mobile*

Sharpdesk Mobile is a mobile print/scan application that combines the convenience of mobile devices and the efficiency of Sharp MFPs to make conducting business on the go easier than ever. Documents scanned on a Sharp MFP can be sent to a mobile device to preview and save. Documents saved on a mobile device can be printed out on the MFP, sent as e-mail attachments, or used in other applications.

* Availability varies by country/region. For details, see the Sharpdesk Mobile support Web site:
http://sharp-world.com/products/copier/docu_solutions/mobile/sharpdesk_mobile/

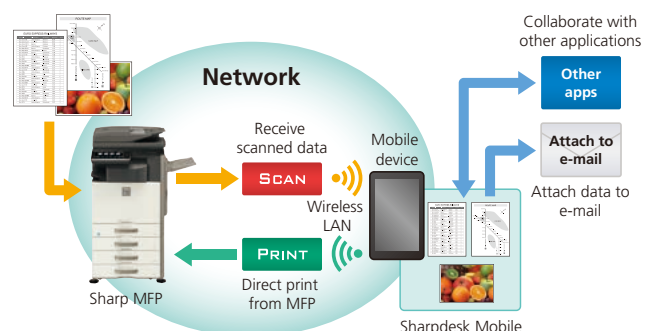



OPTIONS

System Configuration

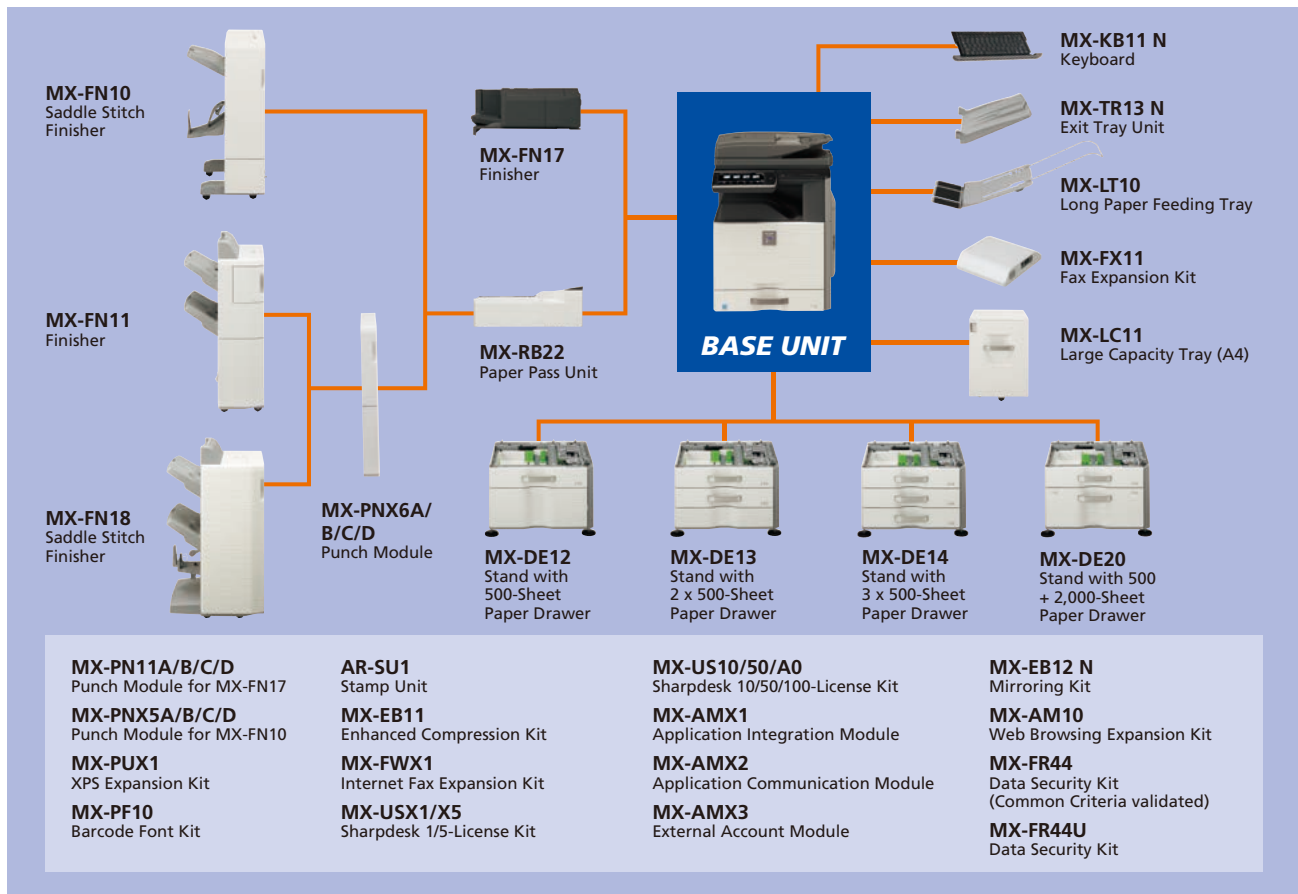

Certain options may not be available in some areas.

Specifications for Options

MX-FN17 Finisher

Paper size	Non offset Offset/staple	A3W (12" x 18") to A5 (5 1/2" x 8 1/2")*1 A3 (11" x 17") to B5*2 (8 1/2" x 11")
Max. paper capacity		500 sheets (A4 or smaller), 250 sheets (B4 or larger)
Max. stapling capacity		50 sheets (A4 or smaller), 30 sheets (B4 or larger)
Staple position		3 locations (front, rear or both)

MX-FN10 Saddle Stitch Finisher

Paper size	Non offset Offset/staple Saddle stitch	A3W (12" x 18") to A5 (5 1/2" x 8 1/2")*1 A3 (11" x 17") to B5 (8 1/2" x 11") A3 (11" x 17"), B4 (8 1/2" x 14"), A4 (8 1/2" x 11")*3
Max. paper capacity	Offset tray Saddle stitch tray	1,000 sheets (A4 or smaller), 500 sheets (B4 or larger) 10 sets of 11–15 sheets, 15 sets of 6–10 sheets, 20 sets of 1–5 sheets
Max. stapling capacity		50 sheets (A4 or smaller), 25 sheets (B4 or larger)
Staple position		3 locations (front, rear or both)

MX-FN11 Finisher

Paper size	Non offset Offset/staple	A3W (12" x 18") to A5 (5 1/2" x 8 1/2")*1 A3 (11" x 17") to B5*2 (8 1/2" x 11")
Max. paper capacity	Upper tray Lower tray	1,550 sheets (A4, 8 1/2" x 11") 2,450 sheets (A4, 8 1/2" x 11")
Max. stapling capacity		50 sheets (A4 or smaller), 30 sheets (A4*4, B4 or larger)
Staple position		3 locations (front, rear or both)

MX-FN18 Saddle Stitch Finisher

Paper size	Non offset Offset/staple Saddle stitch	A3W (12" x 18") to A5 (5 1/2" x 8 1/2")*1 A3 (11" x 17") to B5*2 (8 1/2" x 11") A3 (11" x 17"), B4 (8 1/2" x 14"), A4 (8 1/2" x 11")*3
Max. paper capacity	Upper tray Lower tray Saddle stitch tray	1,550 sheets (A4, 8 1/2" x 11") 2,450 sheets (A4, 8 1/2" x 11") 10 sets of 11–15 sheets, 15 sets of 6–10 sheets, 25 sets of 1–5 sheets
Max. stapling capacity		50 sheets (A4 or smaller), 30 sheets (A4*4, B4 or larger)
Staple position		3 locations (front, rear or both)

Punch Modules

Model name	For the MX-FN17	MX-PN11A	MX-PN11B	MX-PN11C	MX-PN11D
	For the MX-FN10	MX-PNX5A	MX-PNX5B	MX-PNX5C	MX-PNX5D
	For the MX-FN11/FN18	MX-PNX6A	MX-PNX6B	MX-PNX6C	MX-PNX6D
Number of holes		2	3	4	4 (wide)
Paper weight		55 to 256 g/m ² *			

* Guaranteed punchable weight is 55 to 128 g/m².

MX-DE12 Stand with 500-Sheet Paper Drawer

Paper size	A3 (11" x 17") to A5 (5 1/2" x 8 1/2")*1
Paper capacity	500 sheets

MX-DE13 Stand with 2 x 500-Sheet Paper Drawer

Paper size (upper and lower tray)	A3 (11" x 17") to A5 (5 1/2" x 8 1/2")*1
Paper capacity (upper and lower tray)	500 sheets each

MX-DE14 Stand with 3 x 500-Sheet Paper Drawer

Paper size (upper/middle/lower tray)	A3 (11" x 17") to A5 (5 1/2" x 8 1/2")*1
Paper capacity (upper/middle/lower tray)	500 sheets each

MX-DE20 Stand with 500 + 2,000-Sheet Paper Drawer

Paper size (upper tray)	A3 (11" x 17") to A5 (5 1/2" x 8 1/2")*1
(lower right/left tray)	A4 (8 1/2" x 11")
Paper capacity (upper tray)	500 sheets
(lower right tray)	850 sheets
(lower left tray)	1,150 sheets

MX-LT10 Long Paper Feeding Tray

Paper size	Max. 1,200 mm long
Paper capacity	1 sheet

MX-LC11 Large Capacity Tray

Paper size	A4 (8 1/2" x 11")
Paper capacity	3,500 sheets

*1: Only short-edge feeding can be used with A5 (5 1/2" x 8 1/2") paper.

*2: Only long-edge feeding can be used with B5 paper.

*3: Only short-edge feeding can be used with A4 (8 1/2" x 11") paper.

*4: Short-edge feeding.

Note: All specifications relating to paper capacity refer to 80 g/m² paper.

Note: When using Sharpdesk and Sharp OSA, please ask your Sharp representative about PC system requirements.

SPECIFICATIONS (tentative)

General	
Type	Desktop
Engine speed	A4 (8 1/2" x 11")*1: Max. 56/46/36 ppm*2 A3 (11" x 17")*: Max. 26/22/17 ppm
Control panel display	10.1-inch colour LCD touchscreen
Paper size	Max. A3 wide (12" x 18")*3, min. A5 (5 1/2" x 8 1/2")*4
Paper capacity (80 g/m ²)	Standard: 600 sheets (500-sheet tray and 100-sheet multi-bypass tray) Maximum: 6,600 sheets (600 sheets & optional 500 + 2,000-sheet tray and 3,500-sheet tray)
Paper weight**5	Tray: 60 g/m ² to 220 g/m ² (16 lbs bond to 80 lbs cover) Multi-bypass tray: 55 g/m ² to 300 g/m ² (13 lbs bond to 110 lbs cover)
Warm-up time*6	12 sec.
Memory	Standard: 3GB (copy/print shared) 320GB HDD*7 Option: 1GB
Power requirements	Rated local AC voltage ±10%, 50/60 Hz
Power consumption	Max. 1.84 kW (220 to 240V), max. 1.44 kW (100 to 127V)
Dimensions (W x D x H)	618 x 713 x 843 mm (24 2/64" x 28 5/64" x 33 3/16")
Weight (approx.)	MX-M565N/M465N: 78 kg (171.9 lbs) MX-M365N: 77 kg (169.8 lbs)

Copier	
Original paper size	Max. A3 (11" x 17")
First copy time*8	3.7/3.9/4.5 sec.
Continuous copy	Max. 999 copies
Resolution	Scan: 600 x 600 dpi, 600 x 400 dpi, 600 x 300 dpi Print: 1,200 x 1,200 dpi, 600 x 600 dpi, 9,600 (equivalent) x 600 dpi
Gradation	Scan: 256 levels Print: 256 levels (equivalent)
Zoom range	25% to 400% (25% to 200% using DSPF) in 1% increments
Preset copy ratios	Metric: 10 ratios (5R/5E), inch: 8 ratios (4R/4E)

Network Colour Scanner	
Scan method	Push scan (via control panel) Pull scan (TWAIN-compliant application)
Scan speed*9 (colour & B/W)	One-sided: Max. 85 originals/min. Two-sided: Max. 170 originals/min.
Resolution	Push scan: 100, 150, 200, 300, 400, 600 dpi Pull scan: 75, 100, 150, 200, 300, 400, 600 dpi 50 to 9,600 dpi via user setting
File formats	TIFF, PDF, PDF/A, encrypted PDF, compact PDF*10, JPEG*11, XPS
Scanner utility	Sharpdesk
Scan destinations	Scan to e-mail/desktop/FTP server/network folder (SMB)/ USB memory

*1: Long-edge feeding.
*2: 51 ppm for MX-M565N when equipped with MX-FN10.
*3: A3 wide (12" x 18") paper must be fed through multi-bypass tray.
*4: Only short-edge feeding can be used with A5 (5 1/2" x 8 1/2") paper.
*5: Depending on usage conditions and type of paper, printing may not be executed correctly.
*6: At rated voltage, 23°C (73.4°F). May vary depending on operating conditions and environment.
*7: HDD capacity depends on procurement and sourcing status.
*8: Long-edge feeding of A4 (8 1/2" x 11") sheets from paper tray, using document glass, MFP in fully ready condition. May vary depending on operating conditions and environment.
*9: Based on Sharp's A4 standard chart, using document feeder and long-edge feeding. Using factory default settings with Auto Colour Selection off. Scan speed will vary depending on the type of document and the scan settings.
*10: Requires optional MX-EB11.
*11: Colour only.
*12: Storage capacity will vary depending on the type of document and the scan settings.
*13: Some features require option(s).
*14: IPv6 is supported only by LPR printing protocol.
*15: Requires optional MX-PUX1 and 1GB memory.
*16: Based on Sharp's standard chart with approx. 700 characters (A4 or 8 1/2" x 11" long-edge feeding) at standard resolution in Super G3 mode, 33,600 bps, JBIG compression.

Document Filing	
Document filing capacity*12	Main and custom folders: 20,000 pages or 3,000 files Quick file folder: 10,000 pages or 1,000 files
Stored jobs*13	Copy, print, scan, fax
Storage folders	Quick file folder, main folder, custom folder (max. 1,000 folders)
Confidential storage	Password protection

Network Printer	
Resolution	1,200 x 1,200 dpi, 600 x 600 dpi, 9,600 (equivalent) x 600 dpi
Interface	USB 2.0, 10Base-T/100Base-TX/1000Base-T
Supported OS	Windows Server® 2003, Windows Server® 2003 R2, Windows Server® 2008, Windows Server® 2008 R2, Windows Server® 2012, Windows Server® 2012 R2, Windows Vista®, Windows® 7, Windows® 8, Windows® 8.1, Mac OS X 10.4, 10.5, 10.6, 10.7, 10.8, 10.9, 10.10
Network protocols	TCP/IP (IPv4, IPv6), IPX/SPX (NetWare), EtherTalk (AppleTalk)
Printing protocols*14	LPR, Raw TCP (port 9100), POP3 (e-mail printing), HTTP, FTP for downloading print files, EtherTalk printing, IPP
PDL	Standard: PCL 6 emulation, Adobe® PostScript® 3™ Option: XPS*15
Available fonts	80 fonts for PCL, 139 fonts for Adobe PostScript 3

Facsimile (optional MX-FX11 required)	
Compression method	MH/MR/MMR/JBIG
Communication protocol	Super G3/G3
Transmission time	Less than 3 seconds*16
Modem speed	33,600 bps to 2,400 bps with automatic fallback
Transmission resolution	From Standard (203.2 x 97.8 dpi) to Ultra Fine (406.4 x 391 dpi)
Recording size	A3 to A5 (11" x 17" to 5 1/2" x 8 1/2")
Memory	1GB
Greyscale levels	Equivalent to 256 levels

• Design and specifications are subject to change without prior notice.
• Mycrostoner-CAP is a trademark of Sharp Corporation. PCL is a registered trademark of Hewlett-Packard Company. Adobe, PostScript, and PostScript 3 are either registered trademarks or trademarks of Adobe Systems Incorporated in the US and/or other countries. Windows, Windows Server, Windows Vista, and Excel are registered trademarks of Microsoft Corporation in the US and/or other countries. Mac, Mac OS, EtherTalk, and AppleTalk are trademarks of Apple Inc., registered in the US and other countries. All other brand names and product names may be trademarks or registered trademarks of their respective owners.
• The ENERGY STAR logo is a certification mark and may only be used to certify products that have been determined to meet the ENERGY STAR programme requirements. ENERGY STAR and the ENERGY STAR mark are registered trademarks owned by the US Environmental Protection Agency. The ENERGY STAR guidelines apply to products only in the US, the EU, Japan, Canada, Australia, New Zealand, and Taiwan.

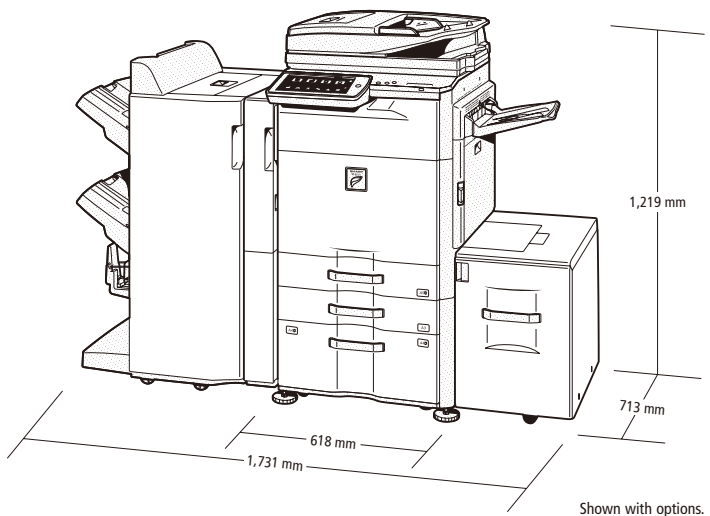

Distributed by:

